

Geometry & Topology
 Volume 4 (2000) 1–83
 Published: 28 January 2000

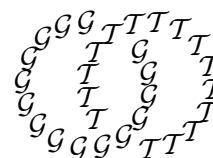

Claspers and finite type invariants of links

KAZUO HABIRO

Graduate School of Mathematical Sciences, University of Tokyo
 3–8–1 Komaba Meguro-ku, Tokyo 153, Japan

Email: habiro@ms.u-tokyo.ac.jp

Abstract

We introduce the concept of “claspers,” which are surfaces in 3–manifolds with some additional structure on which surgery operations can be performed. Using claspers we define for each positive integer k an equivalence relation on links called “ C_k –equivalence,” which is generated by surgery operations of a certain kind called “ C_k –moves”. We prove that two knots in the 3–sphere are C_{k+1} –equivalent if and only if they have equal values of Vassiliev–Goussarov invariants of type k with values in any abelian groups. This result gives a characterization in terms of surgery operations of the informations that can be carried by Vassiliev–Goussarov invariants. In the last section we also describe outlines of some applications of claspers to other fields in 3–dimensional topology.

AMS Classification numbers Primary: 57M25

Secondary: 57M05, 18D10

Keywords: Vassiliev–Goussarov invariant, clasper, link, string link

Proposed: Frances Kirwan
 Seconded: Joan Birman, Robion Kirby

Received: 30 October 1999
 Revised: 27 January 2000

Copyright Geometry and Topology

1 Introduction

In the theory of finite type invariants of knots and links, also called Vassiliev–Goussarov invariants [46] [13] [3] [4] [1] [28], we have a descending filtration, called the Vassiliev–Goussarov filtration, on the free abelian group generated by ambient isotopy classes of links, and dually an ascending filtration on the group of invariants of links with values in an abelian group. Invariants which lie in the k th subgroup in the filtration are characterized by the property that they vanish on the $k + 1$ st subgroup of the Vassiliev–Goussarov filtration, and called invariants of type k .

It is natural to ask when the difference of two links lies in the $k + 1$ st subgroup of the Vassiliev–Goussarov filtration, ie, when the two links are not distinguished by any invariant of type k . If this is the case, then the two links are said to be “ V_k –equivalent.” T Stanford proved in [44] that two links are V_k –equivalent if one is obtained from the other by inserting a pure braid commutator of class $k + 1$. One of the main purposes of this paper is to prove a modified version of the converse of this result:

Theorem 1.1 *For two knots γ and γ' in S^3 and for $k \geq 0$, the following conditions are equivalent.*

- (1) γ and γ' are V_k –equivalent.
- (2) γ and γ' are related by an element of the $k + 1$ st lower central series subgroup (ie, the subgroup generated by the iterated commutators of class $k + 1$) of the pure braid group of n strands for some $n \geq 0$.
- (3) γ and γ' are related by a finite sequence of “simple C_k –moves” and ambient isotopies.

Here a “simple C_k –move” is a local operation on knots defined using “claspers”. (Loosely speaking, a simple C_k –move on a link is an operation which “band-sums a $(k + 1)$ –component iterated Bing double of the Hopf link.” See Figure 34 for the case that $k = 1, 2$ and 3 .)

Theorem 1.1 is a part of Theorem 6.18. M Goussarov independently proved a similar result. Recently, T Stanford proved (after an earlier version [20] of the present paper, in which the equivalence of (1) and (3) of Theorem 1.1 was proved, was circulated) that two knots in S^3 are V_k –equivalent if and only if they are presented as two closed braids differing only by an element of the $k + 1$ st lower central series subgroup of the corresponding pure braid group [45]. The equivalence of 1 and 2 in the above theorem can be derived also

from this result of Stanford. His proof seems to be simpler than ours in some respects, mostly due to the use of commutator calculus in groups, which is well developed in literature. However, we believe that it is worth presenting the proof using claspers here because we think of our technique, *calculus of claspers*, as a calculus of a new kind in 3-dimensional topology which plays a fundamental role in studying finite type invariants of links and 3-manifolds and, moreover, in studying the category theoretic and algebraic structures in 3-dimensional topology.

Calculus of claspers is closely related to three well-known calculi: Kirby's calculus of framed links [26], the diagram calculus of morphisms in braided categories [33], and the calculus of trivalent graphs appearing in theories of finite type invariants of links and 3-manifolds [1] [12]. Let us briefly explain these relationships here.

First, we may think of calculus of claspers as a variant of Kirby's calculus of framed links [26]. The Kirby calculus reduces, to some extent, the study of closed oriented 3-manifolds to the study of framed links in S^3 . Claspers are topological objects in 3-manifolds on which we can perform surgery, like framed links. In fact, surgery on a clasper is defined as surgery on an "associated framed link". Therefore we may think of calculus of claspers as calculus of framed links of a special kind.¹

Second, we may think of calculus of claspers as a kind of diagram calculus for a category **Cob** embedded in a 3-manifold. Here **Cob** denotes the rigid braided strict monoidal category of cobordisms of oriented connected surfaces with connected boundary (see [8] or [24]). Recall that **Cob** is generated as a braided category by the "handle Hopf algebra," which is a punctured torus as an object of **Cob**. Recall also that in diagram calculus for braided category, an object is represented by a vertical line or a parallel family of some vertical lines, and a morphism by a vertex which have some input lines corresponding to the domain and some output lines the codomain (see, eg, [34]). If the braided category in question is the cobordism category **Cob**, then a diagram represents a cobordism. Speaking roughly and somewhat inaccurately, a clasper is a flexible generalization of such a diagram embedded in a 3-manifold and we can perform *surgery* on it, which means removing a regular neighborhood of it and

¹We can easily derive from Kirby's theorem a set of operations on claspers that generate the equivalence relation which says when two claspers yield diffeomorphic results of surgeries. But these moves seems to be not so interesting. An interesting version of "Kirby type theorem" would be equivalent to a presentation of the braided category **Cob** described just below.

gluing back the cobordism represented by the diagram. In this way, we may sometimes think of (a part of) a clasper as a diagram in **Cob**. This enables us to think of claspers *algebraically*.

Third, calculus of claspers is a kind of “topological version” of the calculus of uni-trivalent graphs which appear in theories of finite type invariants of links and 3-manifolds [1] [12]. Claspers of a special kind, which we call “(simple) graph claspers” look very like trivalent graphs, but they are embedded in a 3-manifold and have framings on edges. We can think of a graph clasper as a “topological realization” of a trivalent graph. This aspect of calculus of claspers is very important in that it gives an unifying view on finite type invariants of both links and 3-manifolds. Moreover, we can develop theories of clasper surgery equivalence relations on links and 3-manifolds. We may think of this theory as more fundamental than that of finite type invariants.

From the category theoretical point of view explained above, we may think of the aspect of calculus of claspers related to trivalent graphs as *commutator calculus in the braided category Cob*. This point of view clarifies that *the Lie algebraic structure of trivalent graphs originates from the Hopf algebraic structure in the category Cob*. This observation is just like that the Lie algebra structure of the associated graded of the lower central series of a group is explained in terms of the group structure.

The organization of the rest of this paper is as follows. Sections 2–7 are devoted to definitions of claspers and theories of C_k -equivalence relations and finite type invariants of links. Section 8 is devoted to giving a survey on other theories stemming from calculus of claspers.

In section 2, we define the notion of claspers. A *basic clasper* in an oriented 3-manifold M is a planar surface with 3 boundary components embedded in the interior of M equipped with a decomposition into two annuli and a band. For a basic clasper C , we associate a 2-component framed link L_C , and we define “surgery on a basic clasper C ” as surgery on the associated framed link L_C . Basic claspers serve as building blocks of claspers. A *clasper* in M is a surface embedded in the interior of M decomposed into some subsurfaces. We associate to a clasper a union of basic claspers in a certain way and we define surgery on the clasper G as surgery on associated basic claspers. A *tame clasper* is a clasper on which the surgery does not change the 3-manifold up to a canonical diffeomorphism. We give some moves on claspers and links which does not change the results of surgeries (Proposition 2.7).

In section 3, we define *strict tree claspers*, which are tame claspers of a special kind. We define the notion of C_k -moves on links as surgery on a strict

tree clasper of degree k . The C_k -equivalence is generated by C_k -moves and ambient isotopies. The C_k -equivalence relation becomes finer as k increases (Proposition 3.7). In Theorem 3.17, we give some necessary and sufficient conditions that two links are C_k -equivalent.

In section 4, we define the notion of *homotopy* of claspers with respect to a link γ_0 in a 3-manifold M . If two simple strict forest claspers of degree k (ie, a union of simple strict tree claspers of degree k) are homotopic to each other, then they yield C_{k+1} -equivalent results of surgeries (Theorem 4.3). Moreover, a certain abelian group maps onto the set of C_{k+1} -equivalence classes of links which are C_k -equivalent to a fixed link γ_0 (Theorem 4.7). This abelian group is finitely generated if $\pi_1 M$ is finite.

In section 5, we define a monoid $\mathcal{L}(\Sigma, n)$ of n -string links in $\Sigma \times [0, 1]$, where Σ is a compact connected oriented surface, and study the quotient $\mathcal{L}(\Sigma, n)/C_{k+1}$ by the C_{k+1} -equivalence. The monoid $\mathcal{L}(\Sigma, n)/C_{k+1}$ forms a residually solvable group, and the subgroup $\mathcal{L}_1(\Sigma, n)/C_{k+1}$ of $\mathcal{L}(\Sigma, n)/C_{k+1}$ consisting of the C_{k+1} -equivalence classes of homotopically trivial n -string links forms a group (Theorem 5.4). These groups are finitely generated if Σ is a disk or a sphere (Corollary 5.6). The pure braid group $P(\Sigma, n)$ of n -strands in $\Sigma \times [0, 1]$ forms the unit subgroup of the monoid $\mathcal{L}(\Sigma, n)$ of n -string links in $\Sigma \times [0, 1]$. We show that the commutators of class k of the subgroup $P_1(\Sigma, n)$ of $P(\Sigma, n)$ consisting of homotopically trivial pure braids are C_k -equivalent to 1_n (Proposition 5.10). Using this result, we prove that two links in a 3-manifold are C_k -equivalent if and only if they are “ P'_k -equivalent” (ie, related by an element of the k th lower central series subgroup of a pure braid group in $D^2 \times [0, 1]$) (Theorem 5.12). We give a definition of a graded Lie algebra of string links.

In section 6, we study Vassiliev–Goussarov filtrations using claspers. In 6.1, we recall the usual definition of Vassiliev–Goussarov filtrations and finite type invariants using singular links. In 6.2, we redefine Vassiliev–Goussarov filtrations on links using *forest schemes*, which are finite sets of disjoint strict tree claspers. In 6.3, we restrict our attention to Vassiliev–Goussarov filtrations on string links, and in 6.4, to that on “string knots”, ie, 1-string links in $D^2 \times [0, 1]$ up to ambient isotopy. Clearly, there is a natural one-to-one correspondence between the set of string knots and that of knots in S^3 . We define an additive invariant ψ_k of type k of string knots with values in the group of C_{k+1} -equivalence classes of string knots. The invariant ψ_k is universal among the additive invariants of type k of string knots (Theorem 6.17). Using this, we prove Theorem 6.18, which contains Theorem 1.1.

In section 7, we give some examples. A simple C_k -move is a C_k -move of a

special kind and can be defined also as a band-sum operation of a $(k + 1)$ -component iterated Bing double of the Hopf link. The Milnor $\bar{\mu}$ invariants of length $k + 1$ of links in S^3 are invariants of C_{k+1} -equivalence (Theorem 7.2). The C_k -equivalence relation is more closely related with the Milnor $\bar{\mu}$ invariants than the V_k -equivalence relation.

In section 8, we give a survey of some other aspects of calculus of claspers. In 8.1, we explain the relationships between claspers and a category of surface cobordisms. In 8.2, we generalize the notion of tree claspers to “graph claspers” and explain that graph claspers is regarded as *topological realizations* of univalent graphs. In 8.3, we give a definition of new filtrations on links and “special finite type invariants” of links. In 8.4, we apply claspers to the theory of finite type invariants of 3-manifolds. In 8.5, we define “groups of homology cobordisms of surfaces,” which are extensions of certain quotient of mapping class groups. In 8.6, we relate claspers to embedded gropes in 3-manifolds.

We remark that, after almost finishing the present paper, the author was informed that M Goussarov has given some constructions similar to claspers.

Acknowledgements The author was partially supported by Research Fellowships of the Japan Society for the Promotion of Science for Young Scientists.

This paper is based on my Ph.D thesis [20], and I would like to thank my advisor Yukio Matsumoto for helpful advice and continuous encouragement. I also thank Mikhail Goussarov, Thang Le, Hitoshi Murakami and Tomotada Ohtsuki for useful comments and stimulating conversations.

1.1 Preliminaries

Throughout this paper all manifolds are smooth, compact, connected and oriented unless otherwise stated. Moreover, 3-manifolds are always oriented, and embeddings and diffeomorphism of 3-manifolds are orientation-preserving.

For a 3-manifold M , a *pattern* $P = (\alpha, i)$ on M is the pair of a compact, oriented 1-manifold α and an embedding $i: \partial\alpha \hookrightarrow \partial M$. A *link* γ in M of pattern P is a proper embedding of α into M which restricts to i on boundary. Let γ denote also the image. Two links γ and γ' in M of the same pattern P are said to be *equivalent* (denoted $\gamma \cong \gamma'$) if γ and γ' are related by an ambient isotopy relative to endpoints. Let $[\gamma]$ often denote the equivalence class of a link γ . (In literature, a ‘link’ usually means a finite disjoint union of embedded *circles*. However, we will work with the above extended definition of ‘links’ in

this paper.) We simply say that two links of pattern P are *homotopic* to each other if they are homotopic to each other relative to endpoints.

A *framed link* will mean a link consisting of only circle components which are equipped with framings, ie, homotopy classes of non-zero sections of the normal bundles. In other words, a “framed link” mean a “usual framed link”. Surgery on a framed link is defined in the usual way. The result from a 3–manifold M by surgery on a framed link L in M is denoted by M^L .

For an equivalence relation R on a set S and an element s of S , let $[s]_R$ denote the element of the quotient set S/R corresponding to s . Similarly, for a normal subgroup H of a group G and an element g of G , let $[g]_H$ denote the coset gH of g in the quotient group G/H .

For a group G , the k th lower central series subgroup G_k of G is defined by $G_1 = G$ and $G_{k+1} = [G, G_k]$ ($k \geq 1$), where $[\cdot, \cdot]$ denotes commutator subgroup.

2 Claspers and basic claspers

In this section we introduce the notion of claspers and basic claspers in 3–manifolds. A clasper is a kind of surface embedded in a 3–manifold on which one may perform surgery, like framed links. A clasper in a 3–manifold M is said to be “tame” if the result of surgery yields a 3–manifold which is diffeomorphic to M in a canonical way. We may use a tame clasper to transform a link in M into another. At the end of this section we introduce some operations on claspers and links which do not change the results of surgeries.

2.1 Basic claspers

Definition 2.1 A *basic clasper* $C = A_1 \cup A_2 \cup B$ in a 3–manifold M is a non-oriented planar surface embedded in M with three boundary components equipped with a decomposition into two annuli A_1 and A_2 , and a band² B connecting A_1 and A_2 . We call the two annuli A_1 and A_2 the *leaves* of C and the band B the *edge* of C .

Given a basic clasper $C = A_1 \cup A_2 \cup B$ in M , we associate to it a 2–component framed link $L_C = L_{C,1} \cup L_{C,2}$ in a small regular neighborhood N_C of C in M

²A “band” will mean a disk parametrized by $[0, 1] \times [0, 1]$ such that the two arcs in the boundary corresponding to $\{i\} \times [0, 1]$ ($i = 0, 1$) are attached to the boundary of other surfaces.

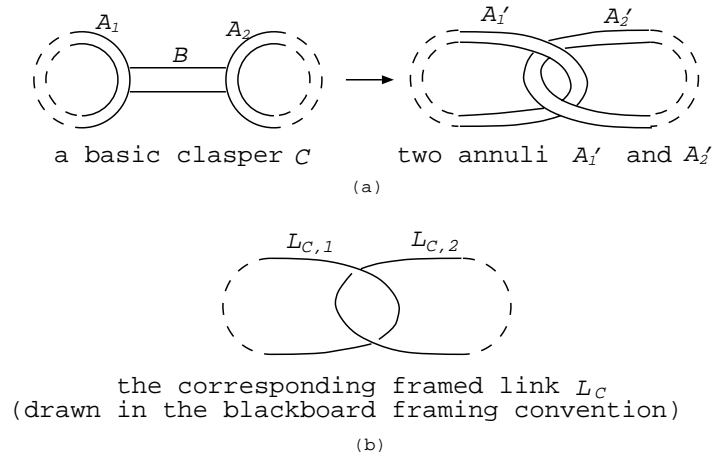

Figure 1: How to associate a framed link to a basic clasper

as follows. Let A'_1 and A'_2 be the two annuli in N_C obtained from A_1 and A_2 by a crossing change along the band B as illustrated in Figure 1a. (Here the crossing must be just as depicted, and it must not be in the opposite way.) The framed link L_C is unique up to isotopy. The framed link $L_C = L_{C,1} \cup L_{C,2}$ is determined by A'_1 and A'_2 as depicted in Figure 1b. Observe that in the definition of L_C , we use the orientation of N_C , but we do *not* need that of the surface C . Observe also that the order of A_1 and A_2 is irrelevant.

We define *surgery on the basic clasper C* to be surgery on the associated framed link L_C . The 3-manifold that we obtain from M by surgery on C is denoted by M^C . When a small regular neighborhood N_C of C in M is specified or clear from context, we may identify M^C with $(M \setminus \text{int}N_C) \cup_{\partial N_C} N_C^C$ (via a diffeomorphism which is identity outside N_C).

The following Proposition is fundamental in that most of the properties of claspers that will appear in what follows are derived from it.

Proposition 2.2 (1) *Let $C = A_1 \cup A_2 \cup B$ be a basic clasper in a 3-manifold M , and D a disk embedded in M such that A_1 is a collar neighborhood of ∂D in D and such that $D \cap C = A_1$. Let N be a small regular neighborhood of $C \cup D$ in M , which is a solid torus. Then there is a diffeomorphism $\varphi_{C,D}|_N: N \xrightarrow{\cong} N^C$ fixing $\partial N = \partial N^C$ pointwise, which extends to a diffeomorphism $\varphi_{C,D}: M \xrightarrow{\cong} M^C$ restricting to the identity on $M \setminus \text{int} N$.*

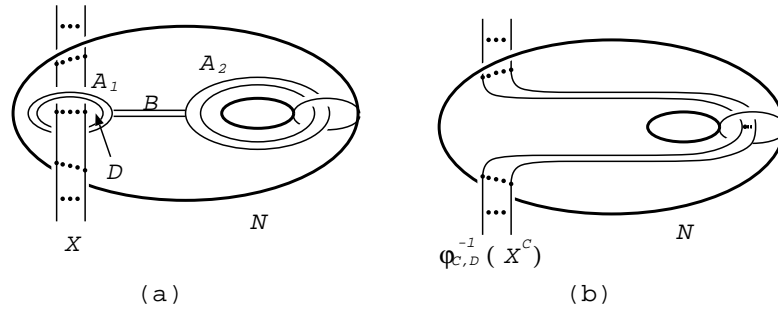

Figure 2: Effect of surgery on a “disked” basic clasper

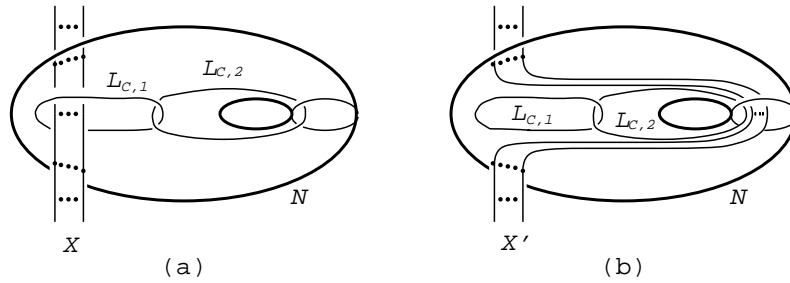

Figure 3: Proof of Lemma 2.2 (2)

(2) In (1) assume that there is a parallel family of “objects” (eg, links, claspers, etc) transversely intersecting the open disk $D \setminus A_1$ as depicted in Figure 2a. Then the object $\varphi_{C,D}^{-1}(X^C)$ in M looks as depicted in Figure 2b.

Proof (1) Let $L_C = L_{C,1} \cup L_{C,2} \subset N$ be the framed link associated to C . The component $L_{C,1}$ bounds a disk D' in $\text{int}N$ intersecting $L_{C,2}$ transversely once, and $L_{C,1}$ is of framing zero. Hence there is a diffeomorphism $\varphi_{C,D}|_N: N \xrightarrow{\cong} N^{L_C} (= N^C)$ restricting to the identity on ∂N .

(2) The associated framed link L_C looks as depicted in Figure 3a. Before performing surgery on L_C , we slide the object X along the component $L_{C,2}$, obtaining an object X' in M depicted in Figure 3b. Since Dehn surgery on L_C in this situation amounts to simply discarding L_C (up to diffeomorphism), the object $\varphi_{C,D}^{-1}(X^C)$ in M looks as depicted in Figure 2b. \square

Remark 2.3 Let C and D be as given in Proposition 2.2(1). The isotopy class of the diffeomorphism $\varphi_{C,D}$ depends not only on C but also to the disk

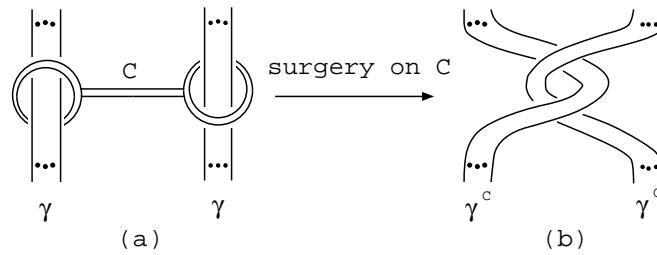

Figure 4: Surgery on a basic clasper clasps two parallel families of strings

D : If the second homotopy group $\pi_2 M$ of M is not trivial, then, for two different bounding disks D_1 and D_2 for L_1 in M , the two diffeomorphisms φ_{C,D_1} and φ_{C,D_2} are not necessarily isotopic to each other. Thus the data D is necessary in the definition of the diffeomorphism $\varphi_{C,D}$. However, if M is a 3-ball or a 3-sphere, then D is unique up to ambient isotopy, and hence $\varphi_{C,D}$ does not depend on D up to isotopy.

Remark 2.4 As a special case of Proposition 2.2, surgery on a basic clasper C linking with two parallel families of strings in a link γ as depicted in Figure 4a amounts to producing a “clasp” of the two parallel families as depicted in Figure 4b. This fact explains the name “clasper.”

2.2 Claspers

Definition 2.5 A *clasper* $G = \mathbf{A} \cup \mathbf{B}$ for a link γ in a 3-manifold M is a non-oriented compact surface embedded in the interior of M and equipped with a decomposition into two subsurfaces \mathbf{A} and \mathbf{B} . We call the connected components of \mathbf{A} the *constituents* of G , and that of \mathbf{B} the *edges* of G . Each edge of G is a band disjoint from γ connecting two distinct constituents, or connecting one constituent with itself. An *end* of an edge B of G is one of the two components of $B \cap \mathbf{A}$, which is an arc in ∂B . There are four kinds of constituents: *leaves*, *disk-leaves*, *nodes* and *boxes*. The leaves are annuli, while the disk-leaves, the nodes and the boxes are disks. The leaves, the nodes and the boxes are disjoint from γ , but the disk-leaves may intersect γ transversely. Also, the constituents must satisfy the following conditions.

- (1) Each node has three incident ends, where it may happen that two of them are the two ends of one edge.
- (2) Each leaf (resp. disk-leaf) has just one incident end, and hence has just one incident edge.

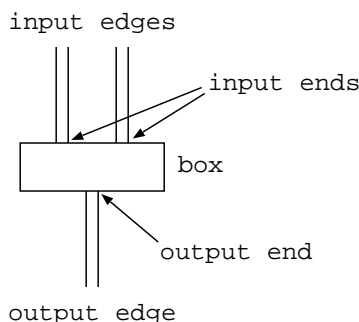

Figure 5: A box

- (3) Each box R of G has three incident ends one of which is distinguished from the other two. We call the distinguished incident end the *output end* of R , and the other two the *input ends* of R . (In Figures we draw a box R as a rectangle as depicted in Figure 5 to distinguish the output end.) The edge containing the output (resp. an input) end of R is called the output (resp. an input) edge of R . (The two ends of an edge B in a clasper may possibly incident to one box R . They may be either the two input ends of R , or one input end and the output end of R . In the latter case B is called both an input edge and the output edge of R .)

A *component* of a clasper G is a connected component of the underlying surface of G together with the decomposition into constituents and edges inherited from that of G .

Two constituents P and Q of G are said to be *adjacent* to each other if there is an edge B incident both to P and to Q . If this is the case, then we also say that P and Q are *connected* by B .

A disk-leaf of a clasper for a link γ is called *trivial* if it does not intersect γ , and *simple* if it intersects γ by just one point.

Given a clasper G , we obtain a clasper C_G consisting of some basic claspers in a small regular neighborhood N_G of G in M by replacing the nodes, the disk-leaves and the boxes of G with some leaves as illustrated in Figure 6. The number of basic claspers contained in C_G is equal to the number of edges in G . We define *surgery on a clasper G* to be surgery on the clasper C_G . More precisely, we define the result M^G from M of surgery on G by

$$M^G = (M \setminus \text{int} N_G) \cup_{\partial N_G} N_G^{C_G}.$$

So, if a regular neighborhood N_G is explicitly specified, then we can identify $M \setminus \text{int} N_G$ with $M^G \setminus \text{int} N_G^G$.

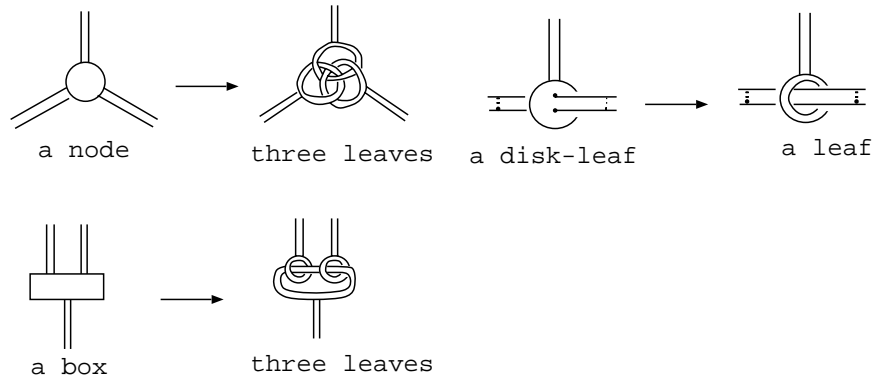

Figure 6: How to replace nodes, disk-leaves and boxes with leaves

Convention 2.6 In Figures we usually draw claspers as illustrated in Figure 7. We follow the so-called blackboard-framing convention to determine the full twists of leaves and edges. The last two rules in Figure 7 show how half twists of edges are depicted.

2.3 Tame claspers

Let $V = V_1 \cup \cdots \cup V_n$ ($n \geq 0$) be a disjoint union of handlebodies in the interior of a 3-manifold M , γ a link in M transverse to ∂V , and $G \subset \text{int}V$ a clasper for γ . We say that G is *tame* in V if there is an orientation-preserving diffeomorphism $\Phi_{(V,G)}|_V: V \xrightarrow{\cong} V^G$ that restricts to the identity on ∂V . If this is the case, then the diffeomorphism $\Phi_{(V,G)}|_V$ extends to the diffeomorphism

$$\Phi_{(V,G)}: M \xrightarrow{\cong} M^G (= M \setminus \text{int}V \cup V^G)$$

restricting to the identity outside V . Observe that $\Phi_{(V,G)}$ is unique up to isotopy relative to $M \setminus \text{int}V$. If there is no fear of confusion, then let $\gamma^{(V,G)}$, or simply γ^G , denote the link $\Phi_{(V,G)}^{-1}(\gamma^G)$ in M , and call it the result from γ of surgery on the pair (V, G) , or often simply on G . Observe that surgery on (V, G) transforms a link in M into another link in M .

We simply say that G is *tame* if G is tame in a regular neighborhood N_G of G in M . If this is the case, we usually let γ^G denote the link $\gamma^{(N_G, G)}$.

If a clasper G is tame in a disjoint union of handlebodies, V , and if $V' \subset \text{int}M$ is a disjoint union of embedded handlebodies containing V , then G is tame

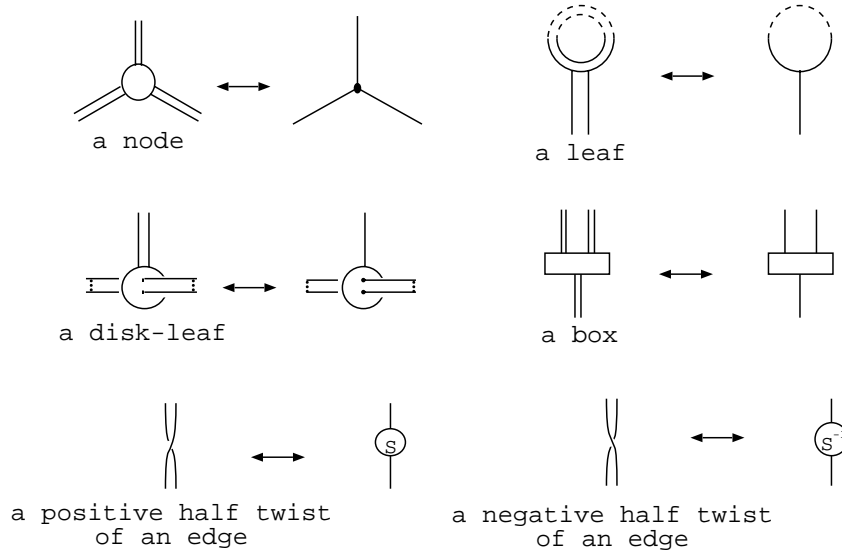

Figure 7: Convention in drawing claspers

also in V' , and the two diffeomorphisms $\Phi_{(V,G)}, \Phi_{(V',G)}: M \xrightarrow{\cong} M^G$ are isotopic relative to $M \setminus \text{int}V'$. Especially, a tame clasper G is tame in any disjoint union of handlebodies in $\text{int}M$ which contains G in the interior.

2.4 Some basic properties of claspers

Let (γ, G) and (γ', G') be two pairs of links and tame claspers in a 3-manifold M . By $(\gamma, G) \sim (\gamma', G')$, or simply by $G \sim G'$ if $\gamma = \gamma'$, we mean that the results of surgeries γ^G and $\gamma'^{G'}$ are equivalent.

Let (γ_A, G_A) and (γ_B, G_B) be two pairs of links and claspers in M and let A and B be two figures which depicts a part of (γ_A, G_A) and a part of (γ_B, G_B) , respectively. In such situations we usually assume that the non-depicted parts of (γ_A, G_A) and (γ_B, G_B) are equal. We mean by ' $A \sim B$ ' in figures that $(\gamma_A, G_A) \sim (\gamma_B, G_B)$.

Proposition 2.7 *Let (γ, G) and (γ', G') be two pairs of links and claspers in M . Suppose that V is a union of handlebodies in M in which G and G' are tame. Suppose that (γ, G) and (γ', G') are related by one of the moves 1–12 performed in V . Then the results of surgery $(\gamma \cap V)^G, (\gamma' \cap V)^{G'}$ are equivalent in V , and hence γ^G and $\gamma'^{G'}$ are equivalent in M .*

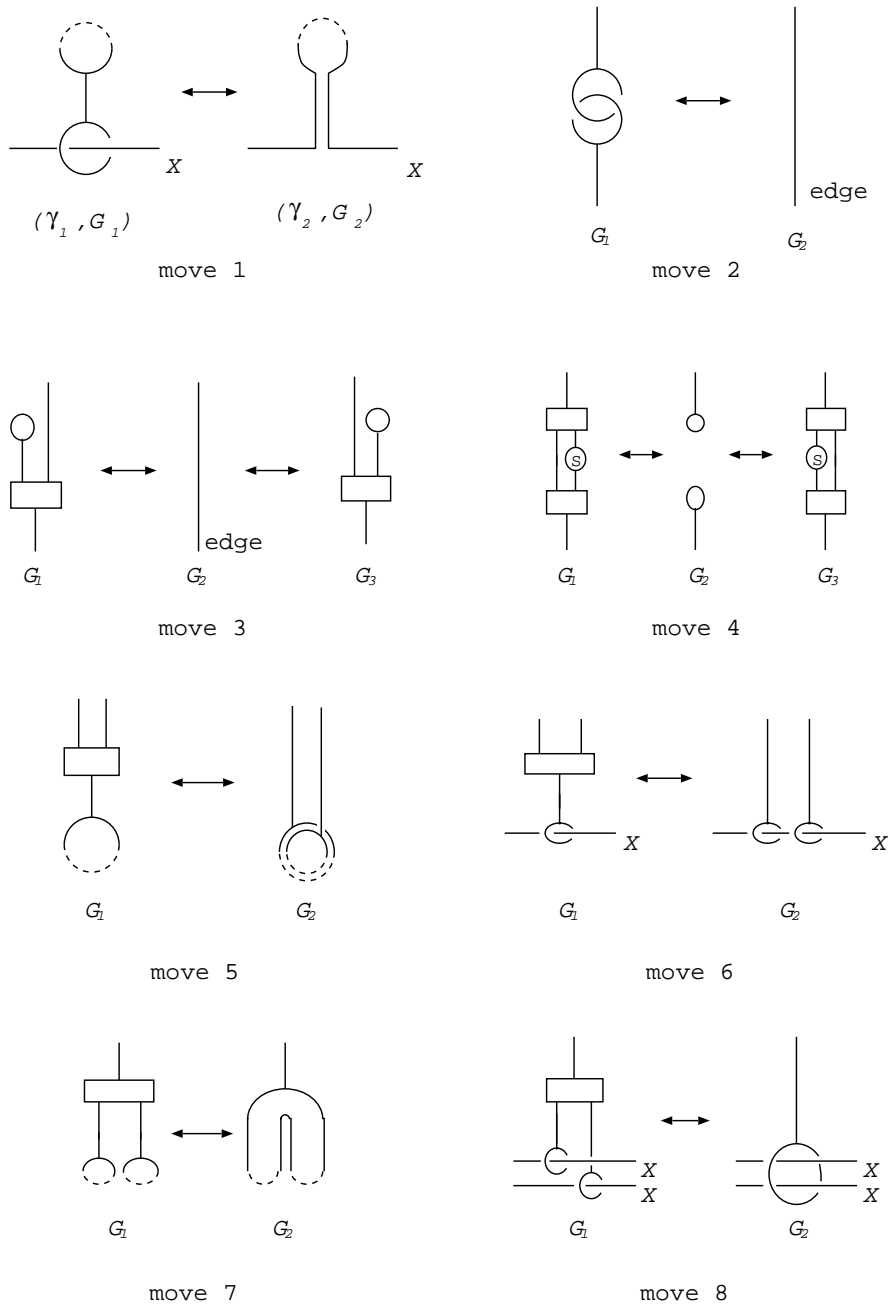

Figure 8: Moves on claspers and links which do not change the result of surgeries. Here $-_X$ represents a parallel family of strings of a link and/or edges and leaves of claspers.

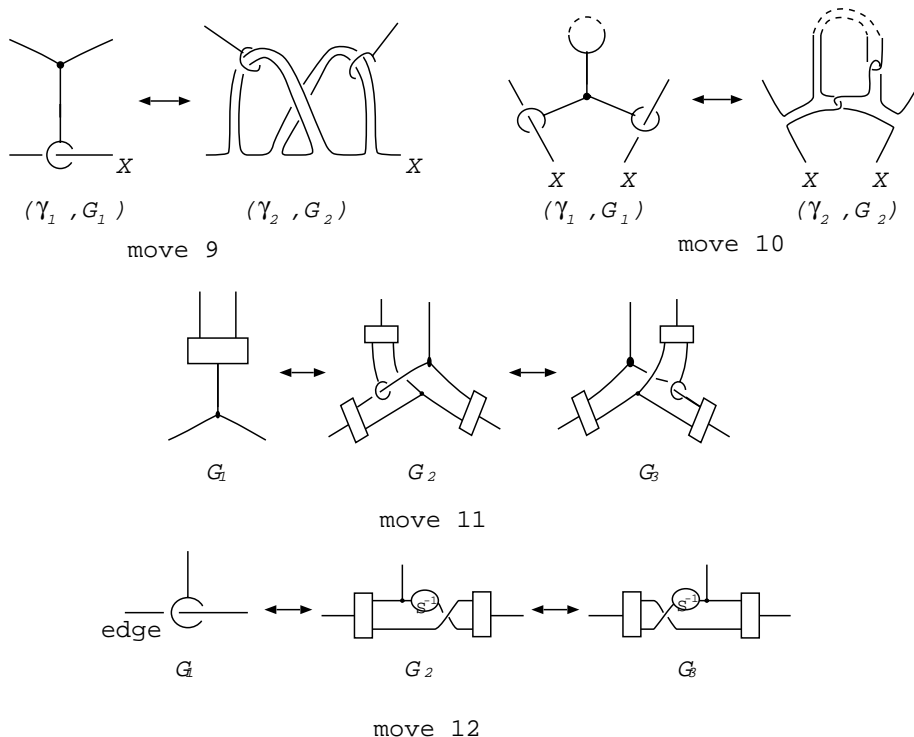

Figure 9: (Continued)

Proof In this proof, let (γ_i, G_i) ($i = 1, 2, 3$) denote the pair of the link and the clasper depicted in the i th term in each row in Figures 8 and 9.

Move 1 This is just Proposition 2.2.

Move 2 We may assume that the edge depicted in the right side and hence one of the edges in the left side are incident to leaves since, if not, we can replace the incident constituent of the edges with some leaves without changing the results of surgeries. Thus we may assume that the clasper on the left side is as depicted in Figure 10a. Surgery on the basic clasper C yields a clasper G'_1 depicted in Figure 10b, which is ambient isotopic to G_2 depicted in Figure 10c. Hence we have $G_1 \sim G_2$.

Move 3 Figure 11 implies $G_1 \sim G_2$. The proof of $G_3 \sim G_2$ is similar.

Move 4 See Figure 12.

Move 5 See Figure 13.

Move 6 Use move 5.

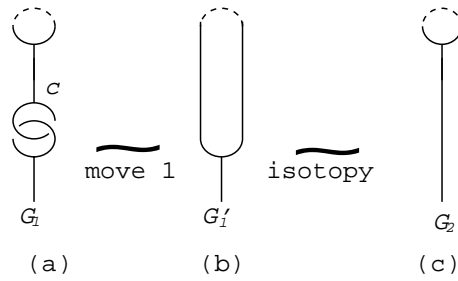

Figure 10: Proof of move 2

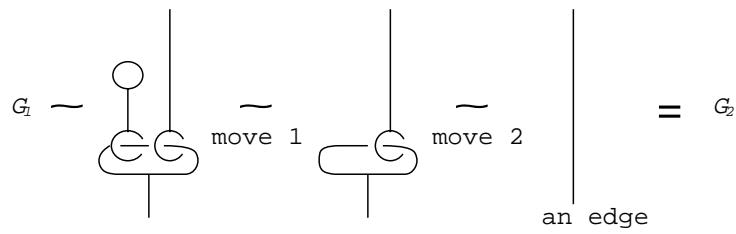

Figure 11: Proof of move 3

Move 7 See Figure 14.

Move 8 Use move 7.

Move 9 See Figure 15.

Move 10 See Figure 16.

Move 11 For $G_1 \sim G_2$, see Figure 17. The proof of $G_1 \sim G_3$ is similar.

Move 12 For $G_1 \sim G_2$, see Figure 18. The proof of $G_1 \sim G_3$ is similar. \square

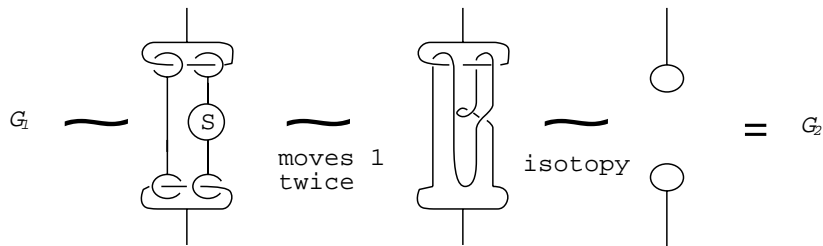

Figure 12: Proof of move 4

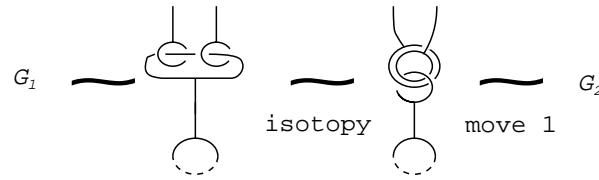

Figure 13: Proof of move 5

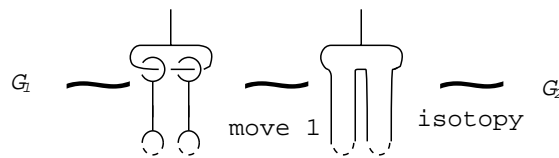

Figure 14: Proof of move 7

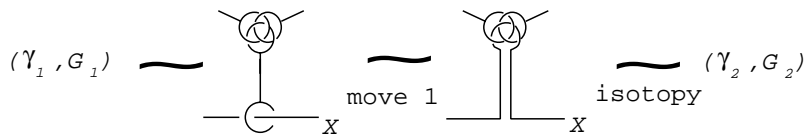

Figure 15: Proof of move 9

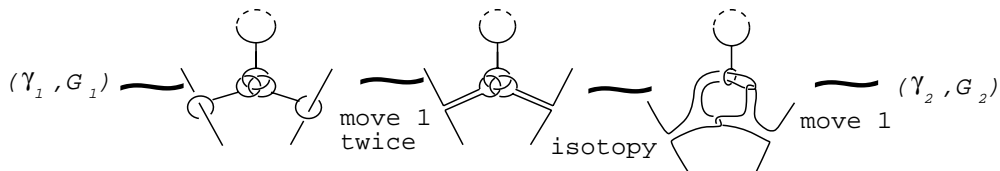

Figure 16: Proof of move 10

Remark 2.8 Proposition 2.7 can be modified as follows. If two pairs (γ, G) and (γ', G') are pairs of links and claspers in M with G and G' not necessarily tame, and if they are related by one of the moves in Proposition 2.7 then the results of surgeries $(M, \gamma)^G, (M, \gamma')^{G'}$ are related by a diffeomorphism restricting to the identity on boundary. This fact will not be used in this paper but in future papers in which we will prove the results announced in Section 8.

Remark 2.9 In Figures 8 and 9, there are no disk-leaves depicted. However, we often use these moves on claspers with disk-leaves by freely replacing disk-leaves with leaves and vice versa.

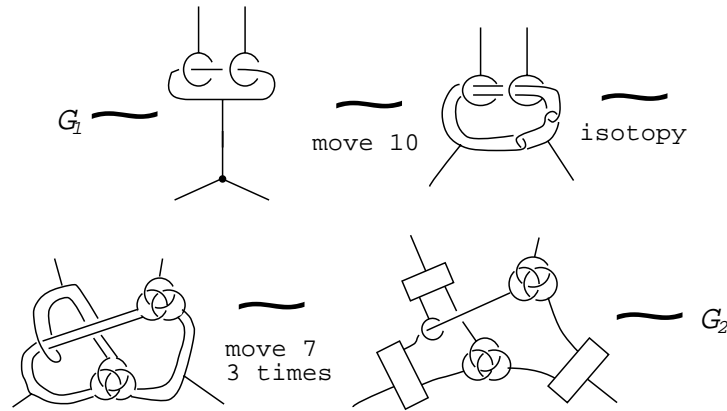

Figure 17: Proof of move 11

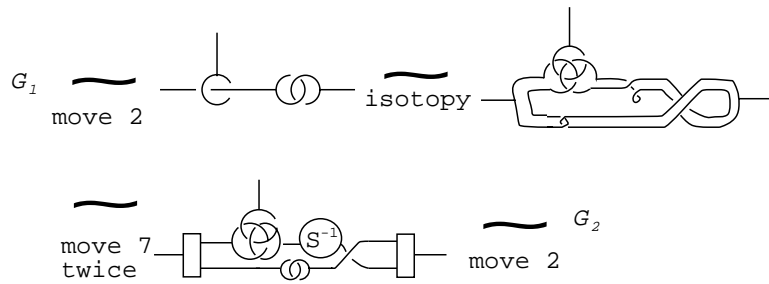

Figure 18: Proof of move 12

3 Tree claspers and the C_k -equivalence relations on links

3.1 Definition of tree claspers

Definition 3.1 A *tree clasper* T for a link γ in a 3-manifold M is a connected clasper without box such that the union of the nodes and the edges of T is simply connected, and is hence “tree-shaped.” Figure 19 shows an example of a tree clasper for a link γ .

A tree clasper T is *admissible* if T has at least one disk-leaf, and is *strict* if (moreover) T has no leaves. Observe that the underlying surface of a strict tree clasper is diffeomorphic to the disk D^2 . A strict tree clasper T is *simple* if every disk-leaf of T is simple.

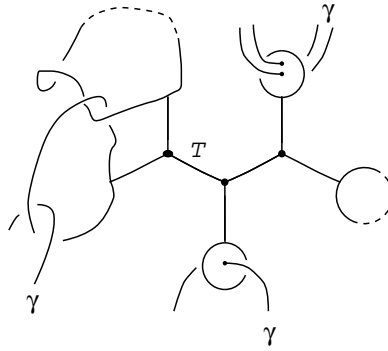

Figure 19: An example of a tree clasper T for a link γ in a 3-manifold M . Leaves of T may link with other leaves, and may run through any part of the manifold M .

Definition 3.2 A forest clasper $T = T_1 \cup \dots \cup T_p$ ($p \geq 0$) for a link γ is a clasper T consisting of p tree claspers T_1, \dots, T_p for γ . The forest clasper T is *admissible*, (resp. *strict*, *simple*) if every component of T is admissible (resp. strict, simple).

Proposition 3.3 Every admissible tree clasper for a link in a 3-manifold M is tame. Especially, every strict tree clasper is tame.

Proof Let T be an admissible tree clasper for a link γ in M , $N_T \subset \text{int}M$ a small regular neighborhood of T in M , and D a disk-leaf of T . If there are other disk-leaves of T , then we may safely replace them with leaves since the tameness in N_T of the new T will imply that of the old T . Assume that D is the only disk-leaf in T . If T has no node, then D is adjacent to a leaf A , and T is tame in N_T by Proposition 2.2. Hence we may assume that T has at least one node, and that the proposition holds for admissible tree claspers which have less nodes than T has. Applying move 9 to D and the adjacent node, we obtain two disjoint admissible tree claspers T_1 and T_2 in N_T for $\gamma' \cong \gamma$ such that there is a diffeomorphism $N_T^T \xrightarrow{\cong} N_T^{T_1 \cup T_2}$ fixing ∂N_T pointwise. Since T_1 and T_2 are tame, there is a diffeomorphism $N_T^T \xrightarrow{\cong} N_T^{T_1 \cup T_2} \xrightarrow{\cong} N_T$ fixing ∂N_T pointwise. Hence T is tame. \square

By Proposition 3.3, an admissible tree clasper T for a link γ in a 3-manifold M determines a link γ^T in M . Hence we may think of surgery on an admissible tree clasper as an operation on links in a *fixed* 3-manifold M .

Proposition 3.4 *Let T be an admissible tree clasper for a link γ in M with at least one trivial disk-leaf. Then γ^T is equivalent to γ .*

Proof There is a sequence of admissible forest claspers for γ , $G_0 = T, G_1, \dots, G_p = \emptyset$ ($p \geq 0$) from T to \emptyset such that, for each $i = 0, \dots, p-1$, G_{i+1} is obtained from G_i by move 1 or by move 9, where the “object to be slid” is empty. Hence we have $\gamma^T = \gamma^{G_0} \cong \gamma^{G_p} = \gamma^\emptyset = \gamma$. \square

3.2 C_k -moves and C_k -equivalence

Definition 3.5 The *degree*, $\deg T$, of a strict tree clasper T for a link γ is the number of nodes of T plus 1. The degree of a strict forest clasper is the minimum of the degrees of its component strict tree claspers.

Definition 3.6 Let M be a 3-manifold and let $k \geq 1$ be an integer. A (simple) C_k -move on a link γ in M is a surgery on a (simple) strict tree clasper of degree k . More precisely, we say that two links γ and γ' in M are related by a (simple) C_k -move if there is a (simple) strict tree clasper T for γ of degree k such that γ^T is equivalent to γ' . We write $\gamma \xrightarrow{C_k} \gamma'$ ($\gamma \xrightarrow{sC_k} \gamma'$) to mean that two links γ and γ' are related by a (simple) C_k -move.

The C_k -equivalence (resp. sC_k -equivalence) is the equivalence relation on links generated by the C_k -moves (resp. simple C_k -moves) and ambient isotopies. By $\gamma \underset{C_k}{\sim} \gamma'$ (resp. $\gamma \underset{sC_k}{\sim} \gamma'$) we mean that γ and γ' are C_k -equivalent (resp. sC_k -equivalent).

The following result means that the C_k -equivalence relation becomes finer as k increases.

Proposition 3.7 *If $1 \leq k \leq l$, then a C_l -move is achieved by a C_k -move, and hence C_l -equivalence implies C_k -equivalence.*

Proof It suffices to show that, for each $k \geq 1$ and for a strict tree clasper T of degree $k+1$ for a link γ in a 3-manifold M , there is a strict tree clasper T' of degree k for γ such that $\gamma^T \cong \gamma^{T'}$. We choose a node V of T which is adjacent to at least two disk-leaves D_1 and D_2 ; see Figure 20a. Applying move 2 to the edge B of T that is incident to V but neither to D_1 nor D_2 , we obtain a clasper $T_1 \cup T_2$ which is tame in a small regular neighborhood N_T of T in M consisting of two admissible tree claspers T_1 and T_2 such that $\gamma^{T_1 \cup T_2} \cong \gamma^T$, see

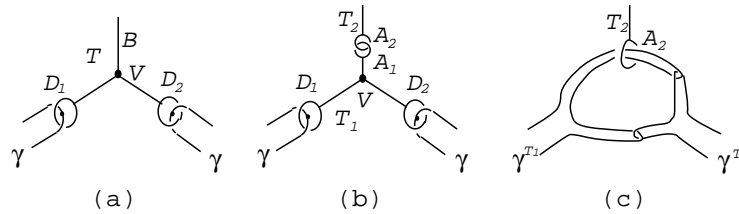

Figure 20

Figure 20b. Here T_1 contains the node V and the two disk-leaves D_1 and D_2 . By move 10 we obtain a link γ^{T_2} such that $\gamma^{T_1 \cup T_2} = (\gamma^{T_1})^{T_2}$, see Figure 20c. Regarding the leaf A_2 as a disk-leaf in the obvious way, we obtain a strict tree clasper T_2 for γ^{T_1} of degree k . Observe that γ^{T_1} is equivalent to γ and that $(\gamma^{T_1})^{T_2} \cong \gamma^T$. Therefore there is a strict tree clasper T' for γ of degree k such that $\gamma^{T'} \cong \gamma^T$. \square

Definition 3.8 Two links in M are said to be C_∞ -equivalent if they are C_k -equivalent for all $k \geq 1$.

Conjecture 3.9 Two links in a 3-manifold M are equivalent if and only if they are C_∞ -equivalent.

3.3 Zip construction

Here we give a technical construction which we call a *zip construction* and which is crucial in what follows.

Definition 3.10 A *subtree* T in a clasper G is a union of some leaves, disk-leaves, nodes and edges of G such that

- (1) the total space of T is connected,
- (2) $T \setminus (\text{leaves of } T)$ is simply connected,
- (3) $T \cap \overline{C \setminus T}$ consists of ends of some edges in T .

We call each connected component of the intersection of T and the closure of $G \setminus T$ an *end of T* , and the edge containing it an *end-edge* of T . A subtree is said to be *strict* if T has no leaves.

An *output subtree* T in G is a subtree of G with just one end that is an output end of a box.

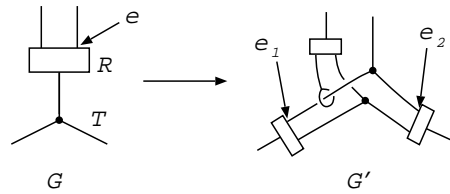

Figure 21

Definition 3.11 A *marking* on a clasper G is a set \mathbf{M} of input ends of boxes such that for each box R of G , at most one input end of R is an element of \mathbf{M} and such that for each $e \in \mathbf{M}$, the box $R \supset e$ is incident to an output subtree.

Definition 3.12 Let G be a clasper for a link γ in M , and \mathbf{M} a marking on G . A *zip construction* $\text{Zip}(G, \mathbf{M})$ is a clasper for γ contained in a small regular neighborhood N_G of G constructed as follows. If \mathbf{M} is empty, then we set $\text{Zip}(G, \emptyset) = G$. Otherwise we define $\text{Zip}(G, \mathbf{M})$ to be a clasper for γ contained in N_G obtained from (G, \mathbf{M}) by iterating the operations of the following kind until the marking \mathbf{M} becomes empty.

- We choose an element $e \in \mathbf{M}$ and let R be the box containing e , T the output subtree, and B the end-edge of T . Let G' be the clasper obtained from G by applying move 5, 6 or 11 to R according as the constituent incident to B at the opposite side of R is a leaf, a disk-leaf or a node, respectively. In the first two cases we set $\mathbf{M}' = \mathbf{M} \setminus \{e\}$, and in the last case we set $\mathbf{M}' = (\mathbf{M} \setminus \{e\}) \cup \{e_1, e_2\}$, where e_1 and e_2 are ends in G' determined as in Figure 21. Then let G' be the new G and \mathbf{M}' the new \mathbf{M} .

This procedure clearly terminates, and the result $\text{Zip}(G, \mathbf{M})$ does not depend on the choice of e in each step. Observe that if there are more than one element in \mathbf{M} , then $\text{Zip}(G, \mathbf{M})$ is obtained from G by separately applying the above construction to each element of \mathbf{M} ; eg, $\text{Zip}(G, \{e, e'\}) = \text{Zip}(\text{Zip}(G, \{e\}), \{e'\})$.

The clasper $\text{Zip}(G, \mathbf{M})$ is unique up to isotopy in N_G . We call it the *zip construction* for (G, \mathbf{M}) . By construction, G and $\text{Zip}(G, \mathbf{M})$ have diffeomorphic results of surgeries. Hence, if G is tame, then $\text{Zip}(G, \mathbf{M})$ is tame in N_G and that the results of surgeries on G and $\text{Zip}(G, \mathbf{M})$ are equivalent.

If \mathbf{M} is a singleton set $\{e\}$, then we set $\text{Zip}(G, e) = \text{Zip}(G, \{e\})$ and call it the zip construction for (G, e) .

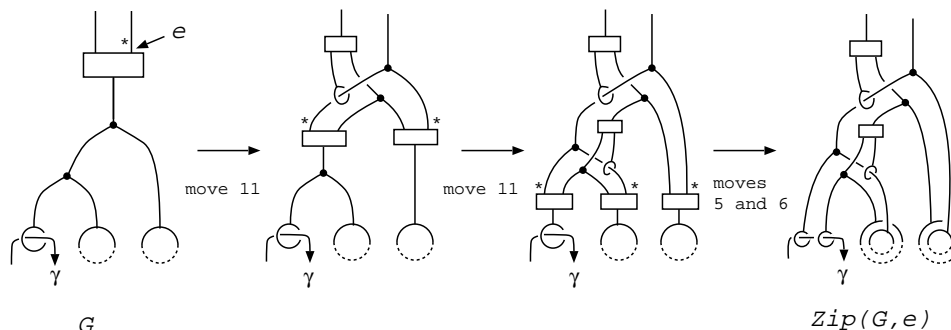

Figure 22

Figure 22 shows an example of zip construction. The name “zip construction” comes from the fact that the procedure of obtaining a zip construction looks like “opening a zip-fastener.”

Definition 3.13 An *input subtree* T of G is a subtree of G each of whose ends is an input end of a box. An input subtree T is said to be *good* if the following conditions hold.

- (1) T is strict.
- (2) The ends of T form a marking of G .
- (3) For each box R incident to T , the output subtree of R is strict.

Each strict output subtree in the condition 3 above is said to be *adjacent* to T .

Definition 3.14 The *degree* of a strict subtree T of a clasper G is half the number of disk-leaves and nodes, which is a half-integer. The *e-degree* (‘e’ for ‘essential’) of a good input subtree T of G is defined to be the sum $\deg T + \deg T_1 + \dots + \deg T_m$, where T_1, \dots, T_m ($m \geq 0$) are the adjacent strict output subtrees of T . The *e-degree* is always a positive integer. We say that T is *e-simple* if T and the T_1, \dots, T_m are all simple.

Definition 3.15 Let G be a clasper and let X be a union of constituents and edges of G . Assume that the incident edges of the leaves, disk-leaves and nodes in X are in X , that the incident constituents of the edges are in X , and that for each box R in X , the output edge of R is in X and at least one of the input edges is in X . Thus X may fail to be a clasper only at some *one-input boxes*, see Figure 23a. Let \tilde{X} denote the clasper obtained from X by “smoothing” the one-input boxes, see Figure 23b. We call \tilde{X} the *smoothing* of X .

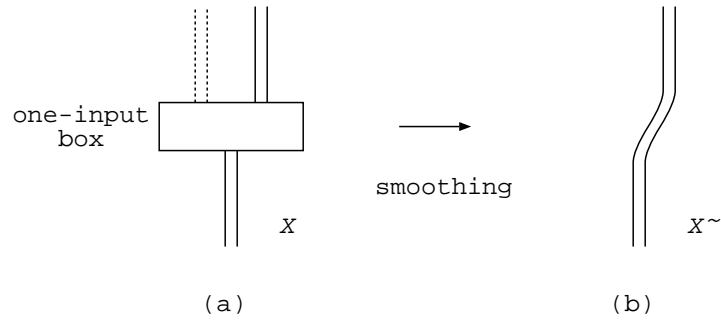

Figure 23

Let Y be a union of constituents and edges of a clasper G such that the closure of $G \setminus Y$ can be smoothed as above. Then the smoothing $(\overline{G \setminus Y})^\sim$ is denoted by $G \ominus Y$.

Lemma 3.16 *Let G be a tame clasper for a link γ in a 3-manifold M , and T a good input subtree of G of e -degree $k \geq 1$. Then γ^G is obtained from $\gamma^{G \ominus T}$ by a C_k -move. If, moreover, T is e -simple, then γ^G is obtained from $\gamma^{G \ominus T}$ by a simple C_k -move.*

Proof Let \mathbf{M} denote the set of ends of T . Then $\text{Zip}(G, \mathbf{M})$ is a disjoint union of a strict tree clasper P of degree k and a clasper Q , see Figure 24a and b. We have $\gamma^Q \cong \gamma^{G \ominus T}$, see Figure 24c. Hence $\gamma^{G \ominus T} \cong \gamma^Q \xrightarrow[C_k]{P} \gamma^{P \cup Q} \cong \gamma^T$.

If T and the output trees adjacent to T are simple, then so is P . Hence γ^T is obtained from $\gamma^{G \ominus T}$ by one simple C_k -move. □

3.4 C_k -equivalence and simultaneous application of C_k -moves

The rest of this section is devoted to proving the following theorem.

Theorem 3.17 *Let γ and γ' be two links in a 3-manifold M and let $k \geq 1$ be an integer. Then the following conditions are equivalent.*

- (1) γ and γ' are C_k -equivalent.
- (2) γ and γ' are sC_k -equivalent.

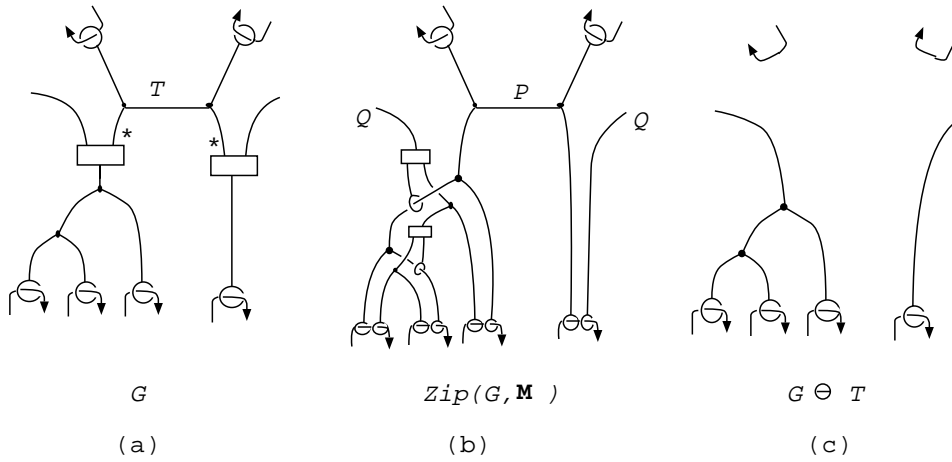

Figure 24: In (a), two asterisks are placed near the two ends of the good input subtree T in G .

- (3) γ' is obtained from γ by surgery on a strict forest clasper $T = T_1 \cup \dots \cup T_l$ ($l \geq 0$) consisting of strict tree claspers T_1, \dots, T_l of degree k .
- (4) γ' is obtained from γ by surgery on a simple strict forest clasper $T = T_1 \cup \dots \cup T_l$ ($l \geq 0$) consisting of simple strict tree claspers T_1, \dots, T_l of degree k .

Remark 3.18 By Proposition 3.7, we may allow in the conditions 3 and 4 above (simple) strict forest claspers of degree k possibly containing components of degree $\geq k$.

Proof of $2 \Rightarrow 1$, $4 \Rightarrow 3$, $3 \Rightarrow 1$ and $4 \Rightarrow 2$ of Theorem 3.17 The implications $2 \Rightarrow 1$ and $4 \Rightarrow 3$ are clear. The implications $3 \Rightarrow 1$ and $4 \Rightarrow 2$ come from the following observation: If $T = T_1 \cup \dots \cup T_l$ ($l \geq 0$) is a (simple) strict forest clasper for γ of degree k , then there is a sequence of (simple) C_k -moves

$$\gamma \xrightarrow{(s)C_k^{T_1}} \gamma^{T_1} \xrightarrow{(s)C_k^{T_2}} \gamma^{T_1 \cup T_2} \xrightarrow{(s)C_k^{T_3}} \dots \xrightarrow{(s)C_k^{T_l}} \gamma^{T_1 \cup \dots \cup T_l}$$

from γ to $\gamma^{T_1 \cup \dots \cup T_l}$. □

In the following we first prove $1 \Rightarrow 2$ by showing that a C_k -move can be achieved by a finite sequence of simple C_k -moves, and then prove $2 \Rightarrow 4$ by showing that a sequence of simple C_k -moves and inverses of simple C_k -moves can be achieved by a surgery on a simple strict forest clasper of degree k .

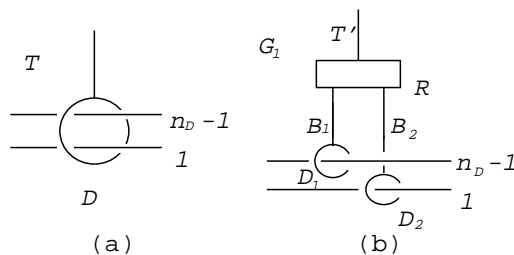

Figure 25

Proof of 1 \Rightarrow 2 of Theorem 3.17 It suffices to prove the following claim.

Claim If a link γ' is obtained from a link γ by surgery on a strict tree clasper T for γ of degree k , then there is a sequence of simple C_k -moves from γ to γ' .

Before proving the claim, we make some definitions which is used only in this proof and the next remark: For a disk-leaf D in a strict tree clasper T for a link γ , let $n(D)$ denote the number of intersection points of D with γ . We also set $n(T) = \prod_D n(D)$, where D runs over all disk-leaves of T .

The proof of the claim is by induction on $n = n(T)$. If $n = 0$, then γ' is equivalent to γ by Proposition 3.4. If $n = 1$, then T is simple, and therefore γ and γ' are related by one simple C_k -move. Let $n \geq 2$ and suppose that the claim holds for strict tree claspers with smaller n . Then there is at least one disk-leaf D of T with $n(D) \geq 2$. Applying move 8 to D , we obtain a clasper G_1 which is tame in a small regular neighborhood N_T of T in M consisting of a box R , a strict output subtree T' , two input edges B_1 and B_2 of R , and two disk-leaves D_1 and D_2 incident to B_1 and B_2 , respectively. Here we have $n(D_1) = n(D) - 1$ and $n(D_2) = 1$, see Figure 25a and b. The union $D_1 \cup B_1$ is a good input subtree of e -degree k . We consider the zip construction $\text{Zip}(G_1, \{B_1 \cap R\}) = P \cup Q$, where P is a strict tree clasper of degree k with $n(P) = (n(D) - 1)n(T)/n(D) < n(T)$. By the induction hypothesis, there is a sequence of simple C_k -moves from γ^Q to $\gamma^{P \cup Q} \cong \gamma^{G_1} \cong \gamma^T$. We have $\gamma^Q \cong \gamma^{Q'}$ by move 3, where $Q' = G_1 \ominus (D_1 \cup B_1)$ is a strict tree clasper of degree k with $n(Q') = n(P)/n(D) < n(P)$. By the induction hypothesis, there is a sequence of simple C_k -moves from γ to $\gamma^{Q'} \cong \gamma^Q$. This completes the proof of the claim and hence that of 1 \Rightarrow 2. \square

Remark 3.19 It is clear from the above proof that surgery on a strict tree clasper T of degree k is achieved by a sequence of $n(T)$ simple C_k -moves.

Before proving $2 \Rightarrow 4$ of Theorem 3.17, we need some definitions and lemmas.

In the following, a *tangle* γ will mean a link in a 3-ball B^3 consisting of only some arcs. A tangle γ is called *trivial* if the pair (B^3, γ) is diffeomorphic to the pair $(D^2 \times [-1, 1], \gamma_0)$ with $\gamma_0 \subset D^2 \times \{0\}$ after smoothing the corners.

For later convenience, the following lemma is stated more strongly than actually needed here.

Lemma 3.20 *Let γ be a trivial tangle in B^3 , and let T be a simple strict tree clasper for γ of degree $k \geq 1$. Suppose that there is a properly embedded disk $D \subset B^3$ such that $T \subset D$ and such that each component of γ transversely intersects D at a point in a disk-leaf of T , see Figure 26a for example. Then the tangle γ^T is trivial. Moreover, γ^T is of the form depicted in Figure 26b, where β is a pure braid of $2k + 2$ strands such that*

- (1) β is contained in the k th lower central series subgroup $P(2k + 2)_k$ of the pure braid group $P(2k + 2)$,
- (2) for each $i = 1, \dots, k + 1$, the result from β of removing the $(2i - 1)$ st and the $2i$ th strands is a trivial pure braid of $2k$ strands, where we number the strings from left to right,
- (3) the first strand of β is trivial and not linked with each others, ie, β has a projection with no crossings on the first strand (by the condition 2, $\beta \setminus$ (the 2nd strand) is trivial).

Proof The proof is by induction on k . If $k = 1$, then the lemma holds since T and γ^T look as depicted in Figure 26c.

Let $k \geq 2$ and suppose that the lemma holds for tree claspers with degree $\leq k - 1$. Applying move 2 to T in an appropriate way, we obtain an admissible forest clasper $T_0 \cup T_1$ such that T_0 has just one node, see Figure 26d. (By an appropriate rotation of B^3 , we may assume that T_0 intersects the first and second strings of γ .) By assumption, there is a $2k$ -strand pure braid β_1 such that

- (1) γ^{T_1} and $T_0^{T_1}$ look as depicted in Figure 26e (here the framing of the (only) leaf of $T_0^{T_1}$ is zero),
- (2) β_1 is contained in $P(2k)_{k-1}$,
- (3) $\beta_1 \setminus$ ($2i - 1$ st and $2i$ th strands) is trivial for $i = 1, \dots, k$,
- (4) the first strand of β_1 is trivial and not linked with the others (hence $\beta_1 \setminus$ (2nd strand) is trivial).

By move 10, the result of surgery $(\gamma^{T_1})^{T_0 T_1} \cong \gamma^{T_0 \cup T_1} \cong \gamma^T$ looks as depicted in Figure 26f, where the $(2k+2)$ -strand pure braid β'_1 is obtained from β_1 by duplicating the first and second strands. By the condition 4 above, $\beta_1^{-1} \setminus$ (the 3rd and 4th strands) is trivial, and hence $(\gamma^{T_1})^{T_0 T_1} \cong \gamma^T$ is equivalent to the tangle γ' depicted in Figure 26g. It is easy to see that $\beta = \beta_1^{-1} \beta_2^{-1} \beta'_1 \beta_2 \in P(2k+2)$ satisfies the condition 1, 2 and 3 of Lemma 3.20. \square

By Lemma 3.20, a C_k -move is an operation which replaces a trivial tangle in a link into another trivial tangle. It is well known that a sequence of such operations can be achieved by a set of simultaneous operations of such kind as in Lemma 3.21.

Lemma 3.21 *Let $\gamma_0, \gamma_1, \dots, \gamma_p$ ($p \geq 0$) be a sequence of links of the same pattern in a 3-manifold M . Suppose that, for each $i = 0, \dots, p-1$, there is a 3-ball B_i in the interior of M such that the two links γ_i and γ_{i+1} coincide outside B_i and such that the tangles $(B_i, \gamma_i \cap B_i)$ and $(B_i, \gamma_{i+1} \cap B_i)$ are trivial and of the same pattern. Then there are disjoint 3-balls B'_0, \dots, B'_{p-1} in the interior of M and diffeomorphisms $\varphi_i: B_i \xrightarrow{\cong} B'_i$ ($i = 0, \dots, p-1$) such that the following conditions hold.*

- (1) For each $i = 0, \dots, p-1$, we have $\varphi_i(B_i \cap \gamma_i) = B'_i \cap \gamma_0$.
- (2) The link γ_p is equivalent to the link

$$\gamma_0 \setminus (\gamma_0 \cap (B'_1 \cup \dots \cup B'_p)) \cup \bigcup_{i=0}^{p-1} \varphi_i(B_i \cap \gamma_{i+1}). \quad (1)$$

Proof The proof is by induction on p . If $p = 0$, the result obviously holds. Let $p \geq 1$ and suppose that the lemma holds for smaller p . Thus there are disjoint 3-balls B'_0, \dots, B'_{p-2} in $\text{int } M$ and diffeomorphisms $\varphi_i: B_i \xrightarrow{\cong} B'_i$ ($i = 0, \dots, p-2$) such that $\varphi_i(B_i \cap \gamma_i) = B'_i \cap \gamma_0$, and such that γ_{p-1} is equivalent to the link

$$\gamma_0 \setminus (\gamma_0 \cap (B'_1 \cup \dots \cup B'_{p-1})) \cup \bigcup_{i=0}^{p-2} \varphi_i(B_i \cap \gamma_{i+1}). \quad (2)$$

We may safely assume that γ_{p-1} is equal to (2). There is a 3-ball B_{p-1} in $\text{int } M$ such that $(B_{p-1}, \gamma_{p-1} \cap B_{p-1})$ and $(B_{p-1}, \gamma_p \cap B_{p-1})$ are trivial tangles with the same pattern. Since (B_{p-1}, γ_{p-1}) is a trivial tangle, there is an isotopy $f_t: M \xrightarrow{\cong} M$ fixing ∂M pointwise and fixing γ_{p-1} as a set, such that $f_0 = \text{id}_M$ and $f_1(B_{p-1})$ is disjoint from $B'_1 \cup \dots \cup B'_{p-1}$. We set $B'_{p-1} = f_1(B_{p-1})$ and

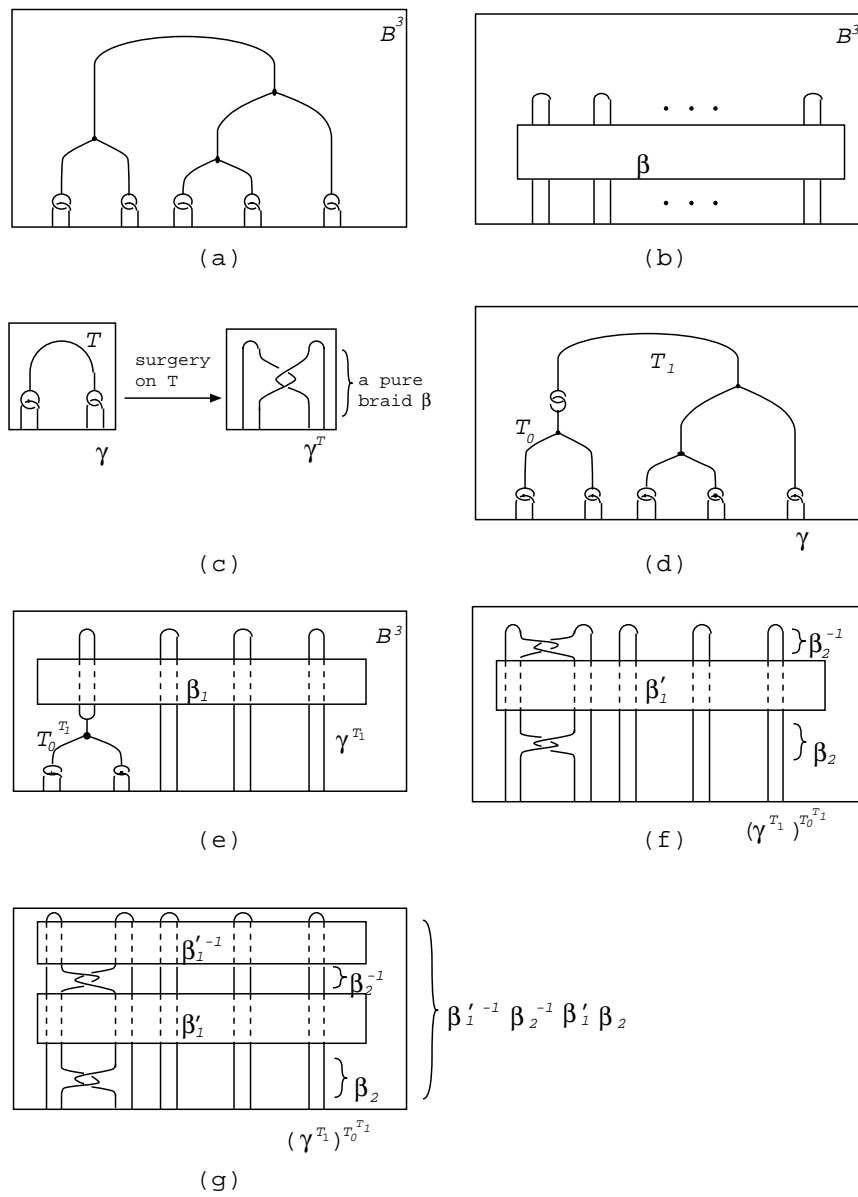

Figure 26

$\varphi_{p-1} = f_1|_{B_{p-1}}$. Then B'_0, \dots, B'_{p-1} and $\varphi_0, \dots, \varphi_{p-1}$ clearly satisfies the conditions 1 the lemma. The condition 2 follows since the link $f_1(\gamma_p)$, which is obviously equivalent to γ_p , is equal to $\gamma_{p-1} \setminus (\gamma_{p-1} \cap B'_{p-1}) \cup \varphi_{p-1}(\gamma_p \cap B_{p-1})$ and hence to the link (1). \square

Using Lemmas 3.20 and 3.21, it is easy to verify the following.

Proposition 3.22 *Let $\gamma_0, \dots, \gamma_p$ ($p \geq 0$) be a sequence of links in a 3-manifold M . Suppose that, for each $i = 0, \dots, p-1$, the links γ_i and γ_{i+1} are related by a (simple) C_{k_i} -move ($k_i \geq 1$). Then there is a (simple) strict forest clasper $T = T_0 \cup \dots \cup T_{p-1}$ such that $\deg T_i = k_i$ for $i = 0, \dots, p-1$ and such that $\gamma_0^{T_1 \cup \dots \cup T_{p-1}}$ is equivalent to γ_p .*

The relation on links defined by (simple) C_k -moves is symmetric as follows.

Proposition 3.23 *If a (simple) C_k -move on a link γ in a 3-manifold M yields a link γ' in M , then a (simple) C_k -move on γ' can yield γ .*

Proof Assume that there is a (simple) strict tree clasper T for γ of degree k such that $\gamma^T \cong \gamma'$. It suffices to show that there is a (simple) strict tree clasper T' for γ^T of degree k disjoint from T such that $(\gamma^T)^{T'} \cong \gamma$.

We choose an edge B of T and replace B with two edges and two trivial disk-leaves, obtaining a strict forest clasper $T_1 \cup T_2$, see Figure 27a and b. By Proposition 3.4, we have $\gamma \cong \gamma^{T_1 \cup T_2}$. By move 4, we have $\gamma^{T_1 \cup T_2} \cong \gamma^{G_1}$, where G_1 is as depicted in Figure 27c. Observe that the edge B_1 is an (e -simple) good input subtree of G_1 of e -degree k . By Lemma 3.16, γ^{G_1} is obtained from $\gamma^{G_1 \ominus B_1}$ by a (simple) C_k -move. Clearly, we have $\gamma^{G_1 \ominus B} \cong \gamma^T$. Hence γ is obtained from γ^T by one (simple) C_k -move. \square

Proof of $2 \Rightarrow 4$ of Theorem 3.17 Suppose that a link γ in M is sC_k -equivalent to a link γ' in M . Then there is a sequence from γ to γ' of simple C_k -moves and inverses of simple C_k -moves. By Proposition 3.23, the inverse simple C_k -moves are replaced with direct simple C_k -moves. By Proposition 3.22, such a sequence can be achieved by a surgery on a simple strict forest clasper consisting of simple strict tree claspers of degree k . \square

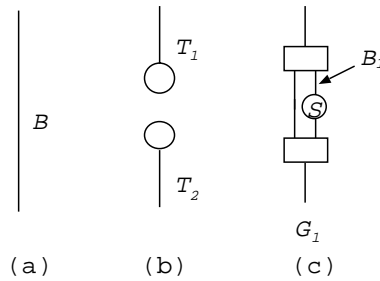

Figure 27

4 Structure of the set of C_{k+1} -equivalence classes of links

4.1 Set of C_{k+1} -equivalence classes of links

It is natural and important to ask when two links of the same pattern are C_k -equivalent. This question decomposes inductively to the question of when two mutually C_k -equivalent links are C_{k+1} -equivalent. Thus the problem reduces to *classifying the C_{k+1} -equivalence classes of links which are C_k -equivalent to a fixed link γ_0* . For a link γ which is C_k -equivalent to γ_0 , Theorem 3.17 enables us to measure “how much they are different” by a simple strict forest clasper for γ_0 of degree k . Hence we wish to know when two such forest claspers give C_{k+1} -equivalent results of surgeries.

Let M be a 3-manifold, and γ_0 a link in M of pattern P . In the following, γ_0 will serve as a kind of “base point” or “origin” in the set of links which are of pattern P . Let $\mathcal{L}(M, \gamma_0)$ denote the set of equivalence classes of links in M which are of pattern P . Though we have $\mathcal{L}(M, \gamma_0) = \mathcal{L}(M, \gamma'_0)$ for any link γ'_0 of pattern P , we denote it by $\mathcal{L}(M, \gamma_0)$ and not by $\mathcal{L}(M, P)$ to remember that γ_0 is the “base point.” We usually write ‘ (γ_0) ’ for ‘ (M, γ_0) ’ if ‘ M ’ is clear from context. For each $k \geq 1$, let $\mathcal{L}_k(\gamma_0)$ denote the subset of $\mathcal{L}(\gamma_0)$ consisting of equivalence classes of links which are C_k -equivalent to γ_0 . Then we have the following descending family of subsets of $\mathcal{L}(\gamma_0)$

$$\mathcal{L}(\gamma_0) \supset \mathcal{L}_1(\gamma_0) \supset \mathcal{L}_2(\gamma_0) \supset \cdots \supset \mathcal{L}_\infty(\gamma_0) \stackrel{\text{def}}{=} \bigcap_{k \geq 1} \mathcal{L}_k(\gamma_0) \ni [\gamma_0], \quad (3)$$

where $[\gamma_0]$ denotes the equivalence class of γ_0 . Conjecture 3.9 is equivalent to that $\mathcal{L}_\infty(\gamma_0) = \{[\gamma_0]\}$ for any link γ_0 in a 3-manifold M .

In order to study the descending family (3), it is natural to consider $\bar{\mathcal{L}}_k(\gamma_0) = \mathcal{L}_k(\gamma_0)/C_{k+1}$, the set of C_{k+1} -equivalence classes of links in M which are C_k -equivalent to the link γ_0 .

Remark 4.1 Before proceeding to study $\bar{\mathcal{L}}_k(\gamma_0)$, we comment on the structure of the set $\mathcal{L}(\gamma_0)/C_1$. Since a simple C_1 -move is just a crossing change of strings, the set $\mathcal{L}(\gamma_0)/C_1$ is identified with the set of homotopy classes (relative to endpoints) of links that are of the same pattern as γ_0 . Therefore elements of $\mathcal{L}(\gamma_0)/C_1$ are described by the homotopy classes of the components of links. There is not any natural group (or monoid) structure on the set $\mathcal{L}(\gamma_0)/C_1$ in general, but there *is* in the case of string links as we will see later.

Definition 4.2 Two claspers for a link γ_0 in M are *isotopic with respect to* γ_0 if they are related by an isotopy of M which preserves the set γ_0 . Two claspers G and G' for a link γ_0 are *homotopic with respect to* γ_0 if there is a homotopy $f_t: G \rightarrow M$ ($t \in [0, 1]$) such that

- (1) f_0 is the identity map of G ,
- (2) f_1 maps G onto G' , respecting the decompositions into constituents,
- (3) for every $t \in [0, 1]$ and for every disk-leaf D of G , $f_t(D)$ intersects γ_0 transversely at just one point in $f_t(\text{int } D)$,
- (4) for each pair of two disk-leaves D and D' contained in one component of G , the points $f_t(D) \cap \gamma_0$ and $f_t(D') \cap \gamma_0$ are disjoint for all $t \in [0, 1]$.

For $k \geq 1$, let $\mathcal{F}_k(\gamma_0)$ denote the set of simple strict forest claspers of degree k for γ_0 . We define a map

$$\sigma_k: \mathcal{F}_k(\gamma_0) \rightarrow \bar{\mathcal{L}}_k(\gamma_0)$$

by $\sigma_k(T_1 \cup \dots \cup T_p) = [\gamma_0^{T_1 \cup \dots \cup T_p}]_{C_{k+1}}$. Let $\mathcal{F}_k^h(\gamma_0)$ denote the quotient of $\mathcal{F}_k(\gamma_0)$ by homotopy with respect to γ_0 .

Theorem 4.3 For a link γ_0 in a 3-manifold M and for $k \geq 1$, the map $\sigma_k: \mathcal{F}_k(\gamma_0) \rightarrow \bar{\mathcal{L}}_k(\gamma_0)$ factors through $\mathcal{F}_k^h(\gamma_0)$.

To prove Theorem 4.3, we need some results. The following three Propositions are used in the proof of Theorem 4.3 and also in later sections.

Proposition 4.4 Let $T_1 \cup T'_1$ be a strict forest clasper for a link γ in a 3-manifold M with $\deg T_1 = k \geq 1$ and $\deg T'_1 = k' \geq 1$. Let $T_2 \cup T'_2$ be a strict forest clasper obtained from $T_1 \cup T'_1$ by sliding a disk-leaf of T_1 over that of T'_1

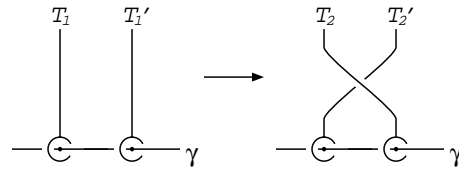

Figure 28

along a component of γ as depicted in Figure 28. Then the two links $\gamma^{T_1 \cup T'_1}$ and $\gamma^{T_2 \cup T'_2}$ in M are related by one $C_{k+k'}$ -move. If, moreover, T_1 and T'_1 (and hence T_2 and T'_2) are simple, then $\gamma^{T_1 \cup T'_1}$ and $\gamma^{T_2 \cup T'_2}$ are related by one simple $C_{k+k'}$ -move.

Proof There is a sequence of claspers for γ from $T_2 \cup T'_2$ to a clasper G as depicted in Figure 29a–f, preserving the result of surgery, as follows. First we obtain b from a by replacing a simple disk-leaf of T with a leaf and then isotoping it. Then we obtain c from b by move 7 and by replacing a leaf with a simple disk-leaf. We obtain d from c by ambient isotopy, e from d by move 12, and f from e by move 6. Let T be the good input subtree of the clasper G . The e -degree of T is equal to $k_1 + k_2$. By Lemma 3.16, $\gamma^G \cong \gamma^{T_2 \cup T'_2}$ is obtained from $\gamma^{G \ominus T} \cong \gamma^{T_1 \cup T'_1}$ by one $C_{k_1+k_2}$ -move.

If T_1 and T'_1 are simple, then the input subtree T is e -simple and hence $\gamma^{T_1 \cup T'_1}$ is obtained from $\gamma^{T_2 \cup T'_2}$ by one simple $C_{k_1+k_2}$ -move. \square

Proposition 4.5 *Let T_1 and T_2 be two strict tree claspers for a link γ of degree k in a 3-manifold M differing from each other only by a crossing change of an edge with a component of γ . Then γ^{T_1} and γ^{T_2} are related by one C_{k+1} -move. If, moreover, T_1 and hence T_2 are simple, then γ^{T_1} and γ^{T_2} are related by one simple C_{k+1} -move.*

Proof We may assume that (T_1, γ) and (T_2, γ) coincide outside a 3-ball in which they look as depicted in Figure 30a and b, respectively. There is a sequence of claspers for γ , preserving the results of surgery, from T_2 to a clasper G as depicted in Figure 30b–d. Here we obtain c from b by move 1, and d from c by move 12. Let T be the good input subtree of G of e -degree $k + 1$ as in d. By Lemma 3.16, $\gamma^G \cong \gamma^{T_2}$ is obtained from $\gamma^{G \ominus T} \cong \gamma^{T_1}$ by a C_{k+1} -move. If T_1 , and hence T_2 , are simple, then this C_{k+1} -move is simple. \square

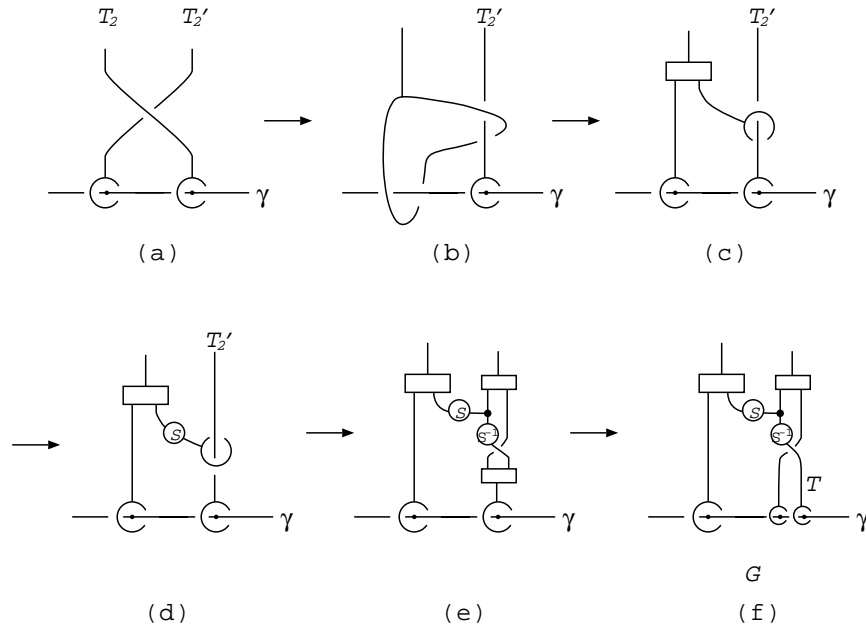

Figure 29

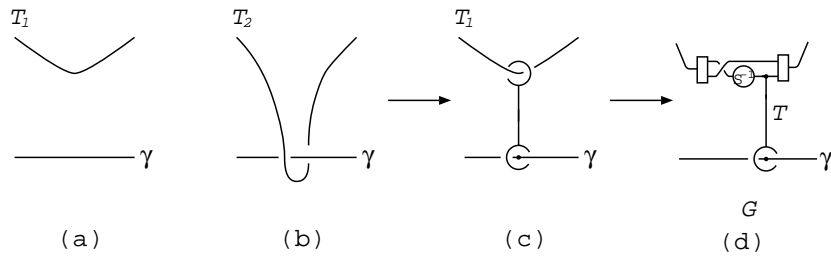

Figure 30

Proposition 4.6 *Let $T_1 \cup T'_1$ be a strict forest clasper for a link γ in M with $\deg T_1 = k \geq 1$ and $\deg T'_1 = k' \geq 1$. Let $T_2 \cup T'_2$ be a forest clasper for γ obtained from $T_1 \cup T'_1$ by passing an edge of T_1 across that of T_2 . Then $\gamma^{T_1 \cup T'_1}$ and $\gamma^{T_2 \cup T'_2}$ are related by one $C_{k+k'+1}$ -move. If, moreover, T_1 and T'_1 and hence T_2 and T'_2 are simple, then $\gamma^{T_1 \cup T'_1}$ and $\gamma^{T_2 \cup T'_2}$ are related by one simple $C_{k+k'+1}$ -move.*

Proof We may assume that $(T_1 \cup T'_1, \gamma)$ and $(T_2 \cup T'_2, \gamma)$ coincide outside a 3-ball in which they look as depicted in Figure 31a and b, respectively. (Here

the 3–ball do not intersect γ .) We obtain from $T_2 \cup T'_2$ a clasper G depicted in Figure 31d as follows. First we obtain c from b by move 1, and d from c by move 12 twice. Note that the input subtree T in G is good and of e –degree $k+k'+1$. The rest of the proof proceeds similarly to that of Proposition 4.5. \square

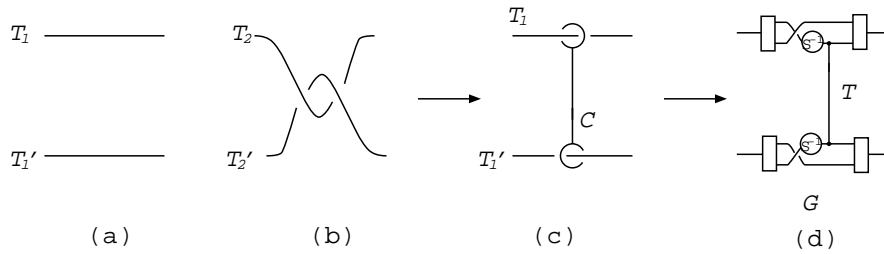

Figure 31

Proof of Theorem 4.3 Suppose that $T = T_1 \cup \dots \cup T_p$ and $T' = T'_1 \cup \dots \cup T'_{p'}$ ($p, p' \geq 0$) are two simple strict forest claspers for γ_0 of degree k which are homotopic to each other with respect to γ_0 . We must show that $\sigma_k(T) = \sigma_k(T')$, ie, $\gamma_0^T \underset{C_{k+1}}{\sim} \gamma_0^{T'}$. By assumption, we have $p = p'$ and, after reordering T'_1, \dots, T'_p if necessary, there is a finite sequence $G_0 = T, G_1, \dots, G_q = T'$ ($q \geq 0$) from T to T' of simple strict forest claspers for γ_0 of degree k such that, for each $i = 0, \dots, q - 1$, the two consecutive simple strict forest claspers G_i and G_{i+1} are related either by

- (1) isotopy with respect to γ_0 ,
- (2) passing an edge of a component across an edge of another component,
- (3) sliding a disk-leaf of a component over a disk-leaf of another component,
- (4) passing an edge of a component across the link γ_0 ,
- (5) passing an edge of a component across another edge of the same component,
- (6) full-twisting an edge of a component.

In each case we must show that $\gamma_0^{G_i} \underset{C_{k+1}}{\sim} \gamma_0^{G_{i+1}}$. The case 1 is clear. The cases 2, 3 and 4 comes from Propositions 4.6, 4.4 and 4.5, respectively. The case 5 reduces to the case 4 since passing an edge of a component across another edge of the same component is achieved by a finite sequence of passing an edge across γ_0 and isotopy with respect to γ_0 . The case 6 reduces to the cases 4 and 5 since full-twisting an edge is achieved by a finite sequence of isotopy with

respect to γ_0 , passing an edge across another, and full-twisting an edge incident to a disk-leaf, which is achieved by passing an edge across γ_0 and isotopies with respect to γ_0 . \square

There is a natural monoid structure on $\mathcal{F}_k^h(\gamma_0)$ with multiplication induced by union and with unit the empty forest clasper. There is a natural 1–1 correspondence between the monoid $\mathcal{F}_k^h(\gamma_0)$ and the free commutative monoid generated by the homotopy classes with respect to γ_0 of simple strict tree claspers for γ_0 of degree k . If $\pi_1 M$ is finite, then the commutative monoid $\mathcal{F}_k^h(\gamma_0)$ is finitely generated.

Let $\tilde{\mathcal{F}}_k^h(\gamma_0)$ denote the (free) abelian group obtained from the free commutative monoid $\mathcal{F}_k^h(\gamma_0)$ by imposing the relation $[S]_h + [S']_h = 0$, where S and S' are two simple strict tree claspers of degree k for γ_0 related to each other by one half twist of an edge, and $[\cdot]_h$ denotes homotopy class with respect to γ_0 . If $\pi_1 M$ is finite, then the abelian group $\tilde{\mathcal{F}}_k^h(\gamma_0)$ is finitely generated.

Theorem 4.7 *For a link γ_0 in a 3–manifold M and for $k \geq 1$, the map $\sigma_k: \mathcal{F}_k(\gamma_0) \rightarrow \tilde{\mathcal{L}}_k(\gamma_0)$ factors through the abelian group $\tilde{\mathcal{F}}_k^h(\gamma_0)$.*

Proof We have only to prove the following claim.

Claim Let $T = T_1 \cup \dots \cup T_p$ ($p \geq 0$) be a simple strict forest clasper for γ_0 in M of degree k and let S and S' be two disjoint simple strict tree claspers for γ_0 of degree k which are disjoint from T . Suppose that S and S' are related by one half-twist of an edge and homotopy with respect to γ_0 in M . Then the two links γ_0^T and $\gamma_0^{T \cup S \cup S'}$ are C_{k+1} –equivalent.

Since, by Theorem 4.3, homotopy with respect to γ_0 preserves the C_{k+1} –equivalence class of the result of surgery on forest claspers of degree k , we may safely assume that the S' is contained in the interior of a small regular neighborhood N of S in M . Moreover, we may assume that S' is obtained from S by a *positive* half twist on an edge B , since, if not, we may exchange the role of S and S' . Let γ_N denote the link $\gamma_0 \cap N$ in N .

Let $G = G_1 \cup G_2$ be the simple strict forest clasper consisting of two strict tree claspers G_1 and G_2 of degree k_1 and k_2 , respectively, ($k_1 + k_2 = k + 1$) such that G is obtained from S by inserting two trivial disk-leaves into the edge B . By Proposition 3.4, γ_N^G is equivalent to γ_N . Let G' be the clasper in N obtained from G by applying move 4. We have $\gamma_N^{G'} \cong \gamma_N^G$. Let B be the edge in G' that is incident to the two boxes and is half twisted, like the

edge B_1 in Figure 27. Let \mathbf{M} denote the set of the two ends of B . The zip construction $\text{Zip}(G', \mathbf{M})$ consists of two components P and Q , satisfying the following properties.

- (1) $\gamma_N^{P \cup Q} \cong \gamma_N$.
- (2) Q is a connected admissible clasper with $\gamma_N^Q \cong \gamma_N^S$.
- (3) P is a simple strict tree clasper in N for γ_N of degree k such that P is homotopic with respect to γ_N to S' in N .

Let N_1 be a small regular neighborhood of N in M which is disjoint from T and let $\gamma_1 = \gamma_0 \cap N_1$. Let P' be a simple strict tree clasper for γ_1 in $N_1 \setminus N_0$ of degree k which is isotopic to S' , and hence to P , with respect to γ_1 in N_1 . We have $\gamma_1^{P'} \cong \gamma_1^P \cong \gamma_1^{S'}$. By the construction of $P \cup Q$, it follows that P is homotopic to P' with respect to γ_1^Q in N_1 , and hence that $(\gamma_1^Q)^P \underset{C_{k+1}}{\sim} (\gamma_1^Q)^{P'}$.

Then we have

$$\gamma_1 \cong \gamma_1^G \cong \gamma_1^{G'} \cong \gamma_1^{P \cup Q} \cong (\gamma_1^Q)^P \underset{C_{k+1}}{\sim} (\gamma_1^Q)^{P'} \cong \gamma_1^{Q \cup P'} \cong \gamma_1^{S \cup S'}$$

This implies that $\gamma_0^T \underset{C_{k+1}}{\sim} \gamma_0^{T \cup S \cup S'}$. This completes the proof of the claim and hence that of Theorem 4.7. □

Remark 4.8 By Theorem 4.7, there is a surjection $\nu_k: \tilde{\mathcal{F}}_k^h(\gamma_0) \rightarrow \bar{\mathcal{L}}_k(\gamma_0)$ satisfying $\sigma_k = \nu_k \circ \text{proj}$, where $\text{proj}: \mathcal{F}_k(\gamma_0) \rightarrow \tilde{\mathcal{F}}_k^h(\gamma_0)$ is the projection.

5 Groups and Lie algebras of string links

In this section we study groups of string links in the product of a connected oriented surface Σ and the unit interval $[0, 1]$ modulo the C_{k+1} -equivalence relation, and we also study the associated graded Lie algebras.

In the following we fix a connected oriented surface Σ and distinct points x_1, \dots, x_n in the interior of Σ , where $n \geq 0$.

5.1 Definition of string links

String links are introduced in [18] to study link-homotopy classification of links in S^3 . We here generalize this notion to string links in $\Sigma \times [0, 1]$. This generalization is natural and almost obvious.

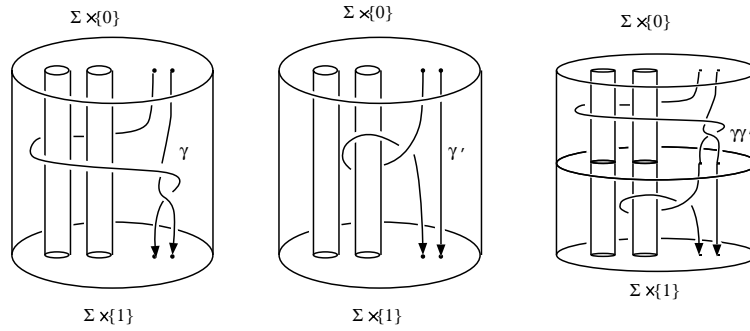

Figure 32: Example of composition of two 2-string links

Definition 5.1 An n -string link $\gamma = \gamma_1 \cup \dots \cup \gamma_n$ in $\Sigma \times [0, 1]$ is a link in $\Sigma \times [0, 1]$ consisting of n disjoint oriented arcs $\gamma_1, \dots, \gamma_n$, such that, for each $i = 1, \dots, n$, γ_i runs from $(x_i, 0)$ to $(x_i, 1)$.

Definition 5.2 An n -string pure braid γ in $\Sigma \times [0, 1]$ is an n -string link γ in $\Sigma \times [0, 1]$ such that, for each $t \in [0, 1]$, the surface $\Sigma \times \{t\}$ transversely intersects γ with just n points.

Composition of n -string links is defined as follows. Let $\gamma = \gamma_1 \cup \dots \cup \gamma_n$ and $\gamma' = \gamma'_1 \cup \dots \cup \gamma'_n$ be two string links in $\Sigma \times [0, 1]$. Then the *composition* $\gamma\gamma' = (\gamma\gamma')_1 \cup \dots \cup (\gamma\gamma')_n$ of γ and γ' is a string link in $\Sigma \times [0, 1]$ defined by

$$(\gamma\gamma')_i = h_0(\gamma_i) \cup h_1(\gamma'_i)$$

for $i = 1, \dots, n$, where $h_0, h_1: \Sigma \times [0, 1] \hookrightarrow \Sigma \times [0, 1]$ are embeddings defined by

$$h_0(x, t) = (x, \frac{1}{2}t), \quad \text{and} \quad h_1(x, t) = (x, \frac{1}{2} + \frac{1}{2}t) \tag{4}$$

for $x \in \Sigma$ and $t \in [0, 1]$. For example, see Figure 32.

The *trivial* n -string link 1_n in $\Sigma \times [0, 1]$ consists of n arcs $(1_n)_i = \{x_i\} \times [0, 1]$, $i = 1, \dots, n$. It is clear that the set $\mathcal{L}(\Sigma, n)$ of equivalence classes of n -string links in $\Sigma \times [0, 1]$ forms a monoid with multiplication induced by the composition operation and with unit the equivalence class $[1_n]$ of 1_n . Here two string links are said to be *equivalent* if they are equivalent as two links in $\Sigma \times [0, 1]$, ie, ambient isotopic to each other relative to endpoints. The subset $P(\Sigma, n)$ of $\mathcal{L}(\Sigma, n)$ consisting of the equivalence classes of n -string pure braids in $\Sigma \times [0, 1]$ forms the unit subgroup of the monoid $\mathcal{L}(\Sigma, n)$, ie, the (maximal) subgroup in $\mathcal{L}(\Sigma, n)$ consisting of all the invertible elements.

5.2 String links modulo C_k -equivalence

For $k \geq 1$, let $\mathcal{L}_k(\Sigma, n)$ denote the submonoid of $\mathcal{L}(\Sigma, n)$ consisting of the equivalence classes of n -string links which are C_k -equivalent to the trivial n -string link 1_n . That is, $\mathcal{L}_k(\Sigma, n) = \mathcal{L}_k(\Sigma \times [0, 1], 1_n)$. There is a descending filtration of monoids

$$\mathcal{L}(\Sigma, n) \supset \mathcal{L}_1(\Sigma, n) \supset \mathcal{L}_2(\Sigma, n) \supset \cdots . \quad (5)$$

Observe that $\mathcal{L}_1(\Sigma, n)$ is just the set of equivalence classes of homotopically trivial n -string links in $\Sigma \times [0, 1]$, where γ is said to be *homotopically trivial* if it is homotopic to 1_n . If Σ is a disk D^2 or a sphere S^2 , then we have $\mathcal{L}(\Sigma, n) = \mathcal{L}_1(\Sigma, n)$.

Let $l \geq k$. Let $\mathcal{L}_k(\Sigma, n)/C_l$ denote the quotient of $\mathcal{L}_k(\Sigma, n)$ by the C_l -equivalence. Also let $\mathcal{L}(\Sigma, n)/C_l$ denote the quotient of $\mathcal{L}(\Sigma, n)$ by C_l -equivalence. In the obvious way, the set $\mathcal{L}_k(\Sigma, n)/C_l$ is identified with the set of C_l -equivalence classes of n -string links that are C_k -equivalent to 1_n . It is easy to see that the monoid structure on $\mathcal{L}_k(\Sigma, n)$ induces that of $\mathcal{L}_k(\Sigma, n)/C_l$. There is a filtration on $\mathcal{L}(\Sigma, n)/C_l$ of finite length

$$\mathcal{L}(\Sigma, n)/C_l \supset \mathcal{L}_1(\Sigma, n)/C_l \supset \mathcal{L}_2(\Sigma, n)/C_l \supset \cdots \supset \mathcal{L}_l(\Sigma, n)/C_l = \{1\}. \quad (6)$$

Since C_1 -equivalence is just homotopy (relative to endpoints), we have the following.

Proposition 5.3 *The monoid $\mathcal{L}(\Sigma, n)/C_1$ is isomorphic to the direct product $(\pi_1 \Sigma)^n$ of n copies of the fundamental group $\pi_1 \Sigma$ of Σ . Hence $\mathcal{L}(\Sigma, n)/C_1$ is finitely generated and residually nilpotent.*

The following is the main result of this section.

Theorem 5.4 *Let Σ be a connected oriented surface. Let $n \geq 0$ and $1 \leq k \leq l$. Then we have the following.*

- (1) *The monoid $\mathcal{L}_k(\Sigma, n)/C_l$ is a nilpotent group.*
- (2) *The monoid $\mathcal{L}(\Sigma, n)/C_l$ is a residually solvable group. More precisely, $\mathcal{L}(\Sigma, n)/C_l$ is an extension of the residually nilpotent group $\mathcal{L}(\Sigma, n)/C_1$ by the nilpotent group $\mathcal{L}_1(\Sigma, n)/C_l$.*
- (3) *If Σ is a disk or a sphere, then the groups $\mathcal{L}(\Sigma, n)/C_l = \mathcal{L}_1(\Sigma, n)/C_l$ and $\mathcal{L}_k(\Sigma, n)/C_l$ are finitely generated.*

- (4) If Σ is a disk or a sphere and if $n = 1$, then $\mathcal{L}(\Sigma, n)/C_l = \mathcal{L}_1(\Sigma, n)/C_l$ and $\mathcal{L}_k(\Sigma, n)/C_l$ are abelian.
- (5) We have

$$[\mathcal{L}_k(\Sigma, n)/C_l, \mathcal{L}_{k'}(\Sigma, n)/C_l] \subset \mathcal{L}_{k+k'}(\Sigma, n)/C_l,$$

for $k, k' \geq 1$ with $k + k' \leq l$, where $[-, -]$ denotes the commutator subgroup. Especially, $\mathcal{L}_k(\Sigma, n)/C_l$ is abelian if $1 \leq k \leq l \leq 2k$.

- (6) The subgroup $\mathcal{L}_k(\Sigma, n)/C_l$ of $\mathcal{L}(\Sigma, n)/C_l$ is normal in $\mathcal{L}(\Sigma, n)/C_l$ (and hence in $\mathcal{L}_{k'}(\Sigma, n)/C_l$ with $1 \leq k' \leq k$). The quotient group

$$(\mathcal{L}(\Sigma, n)/C_l)/(\mathcal{L}_k(\Sigma, n)/C_l)$$

is naturally isomorphic to $\mathcal{L}(\Sigma, n)/C_k$. Similarly,

$$(\mathcal{L}_{k'}(\Sigma, n)/C_l)/(\mathcal{L}_k(\Sigma, n)/C_l) \cong \mathcal{L}_{k'}(\Sigma, n)/C_k.$$

To prove Theorem 5.4, we consider the submonoid $\bar{\mathcal{L}}_k(\Sigma, n) \stackrel{\text{def}}{=} \mathcal{L}_k(\Sigma, n)/C_{k+1}$ ($= \bar{\mathcal{L}}_k(\Sigma \times [0, 1], 1_n)$) of $\mathcal{L}(\Sigma, n)/C_{k+1}$. We set $\tilde{\mathcal{F}}_k^h(\Sigma, n) = \tilde{\mathcal{F}}_k^h(\Sigma \times [0, 1], 1_n)$. By Remark 4.8, there is a natural surjective map of sets $\nu_k: \tilde{\mathcal{F}}_k^h(\Sigma, n) \rightarrow \bar{\mathcal{L}}_k(\Sigma, n)$. We have the following lemma.

Lemma 5.5 *The map $\nu_k: \tilde{\mathcal{F}}_k^h(\Sigma, n) \rightarrow \bar{\mathcal{L}}_k(\Sigma, n)$ is a surjective homomorphism of monoids. Hence $\bar{\mathcal{L}}_k(\Sigma, n)$ is an abelian group.*

Proof First, we have $\nu_k(0) = [1_n^{\emptyset}]_{C_{k+1}} = [1_n]_{C_{k+1}} = 1_{\bar{\mathcal{L}}_k(\Sigma, n)}$. Second, for two elements a and b in $\tilde{\mathcal{F}}_k^h(\Sigma, n)$, we choose two forest claspers $T^a = T_1^a \cup \dots \cup T_p^a$ and $T^b = T_1^b \cup \dots \cup T_q^b$ of degree k for 1_n representing a and b , respectively. We may assume that $T^a \subset [0, \frac{1}{2}]$ and $T^b \subset \Sigma \times [\frac{1}{2}, 1]$ since, by Theorem 4.3, homotopy with respect to 1_n preserves the C_{k+1} -equivalence class of results of surgeries. Hence the forest clasper $T^a \cup T^b$ represents the element $a + b$. We have

$$\begin{aligned} \nu_k(a + b) &= [1_n^{T^a \cup T^b}]_{C_{k+1}} = [1_n^{T^a} 1_n^{T^b}]_{C_{k+1}} = [1_n^{T^a}]_{C_{k+1}} [1_n^{T^b}]_{C_{k+1}} \\ &= \nu_k(a) \nu_k(b). \end{aligned}$$

Hence ν_k is a surjective homomorphism of monoids. Since $\tilde{\mathcal{F}}_k^h(\Sigma, n)$ is a group, so is $\bar{\mathcal{L}}_k(\Sigma, n)$. \square

The following is clear from Lemma 5.5.

Corollary 5.6 *If Σ is a disk or a sphere, then $\bar{\mathcal{L}}_k(\Sigma, n)$ is finitely generated.*

Proof of 1, 2, 3 and 4 of Theorem 5.4 We first prove that $\mathcal{L}_k(\Sigma, n)/C_l$ is a group. The proof is by a descending induction on k . If $k = l$, then there is nothing to prove. Let $1 \leq k < l$ and suppose that $\mathcal{L}_{k+1}(\Sigma, n)/C_l$ is a nilpotent group. Then we have a short exact sequence of monoids

$$1 \rightarrow \mathcal{L}_{k+1}(\Sigma, n)/C_l \rightarrow \mathcal{L}_k(\Sigma, n)/C_l \rightarrow \bar{\mathcal{L}}_k(\Sigma, n) \rightarrow 1,$$

where $\mathcal{L}_{k+1}(\Sigma, n)/C_l$ and $\bar{\mathcal{L}}_k(\Sigma, n)$ are groups. Hence $\mathcal{L}_k(\Sigma, n)/C_l$ is also a group. The nilpotency is proved using the property (5) of the theorem proved below. This completes the proof of 1.

The statement 2 holds since there is a short exact sequence of monoids

$$1 \rightarrow \mathcal{L}_1(\Sigma, n)/C_l \rightarrow \mathcal{L}(\Sigma, n)/C_l \rightarrow \mathcal{L}(\Sigma, n)/C_1 \rightarrow 1.$$

If Σ is a disk or a sphere, then the group $\mathcal{L}_k(\Sigma, n)/C_l$ is an iterated extension of finitely generated abelian groups $\mathcal{L}_k(\Sigma, n)/C_{k+1}, \dots, \mathcal{L}_{l-1}(\Sigma, n)/C_l$. Hence the statement 3 holds.

If Σ is a disk or a sphere and if $n = 1$, then the monoid $\mathcal{L}_1(\Sigma, n)$ is commutative. Hence the statement 4 holds. \square

Before proving the rest of Theorem 5.4, we prove some results.

Proposition 5.7 *Let $1 \leq k \leq l$ and let γ and γ' be two n -string links in $\Sigma \times [0, 1]$ which are C_k -equivalent to each other. Then γ' is C_l -equivalent to an n -string link*

$$\gamma'' = \gamma 1_n^{T_1} \dots 1_n^{T_p}, \quad p \geq 0,$$

where T_1, \dots, T_p are simple strict tree claspers for 1_n such that

$$k \leq \deg T_1 \leq \dots \leq \deg T_p \leq l - 1.$$

Proof The proof is by induction on l . If $l = k$, then there is nothing to prove. Let $l > k$ and suppose that γ' is C_l -equivalent to the n -string link γ'' given as above. We must show that γ' is C_{l+1} -equivalent to $\gamma'' 1_n^{T_{p+1}} \dots 1_n^{T_{p+q}}$ ($q \geq 0$), where T_{p+1}, \dots, T_{p+q} are simple strict tree claspers for 1_n of degree l . Since γ'' is C_l -equivalent to γ' , by Theorem 3.17 there is a simple strict forest clasper $T' = T'_{p+1} \cup \dots \cup T'_{p+q}$ ($q \geq 0$) for γ'' consisting of simple strict tree claspers of degree l such that $\gamma''^{T'} \cong \gamma'$. By a homotopy with respect to γ'' followed by an ambient isotopy fixing endpoints, we obtain from T' a simple strict forest clasper $T'' = T''_{p+1} \cup \dots \cup T''_{p+q}$ for the composition $\gamma'' 1_n$ such that

- (1) for each $i = 1, \dots, q$, T_i'' is contained in $\Sigma \times [\frac{1}{2}, 1]$,
- (2) for each distinct $i, j \in \{1, \dots, q\}$, we have $p(T_i'') \cap p(T_j'') = \emptyset$, where $p: \Sigma \times [0, 1] \rightarrow [0, 1]$ is the projection.

We have

$$(\gamma''1_n)^{T''} \cong \gamma''1_n^{T''} \cong \gamma''1_n^{T''_{p+1}} \dots 1_n^{T''_{p+q}}$$

(after renumbering if necessary). By Theorem 4.3, $(\gamma''1_n)^{T''}$ is C_{l+1} -equivalent to γ' . That is, the simple strict tree claspers $T''_{p+1}, \dots, T''_{p+q}$ satisfies the required condition. \square

Proposition 5.8 *Let γ and γ' be two n -string links in $\Sigma \times [0, 1]$ which are C_k -equivalent and $C_{k'}$ -equivalent, respectively, to 1_n , where $k, k' \geq 1$. Then the two compositions $\gamma\gamma'$ and $\gamma'\gamma$ are $C_{k+k'}$ -equivalent to each other.*

Proof By Proposition 5.7, there is a simple strict forest clasper $T = T_1 \cup \dots \cup T_p$ for 1_n of degree k with $1_n^T \cong \gamma$ and there is a simple strict forest clasper $T' = T'_1 \cup \dots \cup T'_{p'}$ for 1_n of degree k' with $1_n^{T'} \cong \gamma'$. There is a sequence of claspers consisting of simple strict tree claspers of degree k or k' for 1_n from $T \cdot T'$ to $T' \cdot T$ (here we define $T \cdot T' = h_0(T) \cup h_1(T')$ with h_0 and h_1 defined by (4)) such that each consecutive two claspers are related by either one of the following operations:

- (1) ambient isotopy fixing endpoints,
- (2) sliding a disk-leaf of a simple strict tree clasper of degree k with a disk-leaf of another simple strict tree clasper of degree k' ,
- (3) passing an edge of a simple strict tree clasper of degree k across an edge of a simple strict tree clasper of degree k' .

By Propositions 4.4 and 4.6, the result of surgery does not change up to $C_{k+k'}$ -equivalence under an operation of the above type. Therefore $\gamma\gamma'$ and $\gamma'\gamma$ are $C_{k+k'}$ -equivalent. \square

Proof of 5 of Theorem 5.4 By Proposition 5.8, an element a of $\mathcal{L}_k(\Sigma, n)/C_l$ and an element b of $\mathcal{L}_{k'}(\Sigma, n)/C_l$ commute up to $C_{k+k'}$ -equivalence. Hence the commutator $[a, b] = a^{-1}b^{-1}ab$ is $C_{k+k'}$ -equivalent to 1_n . This means that $[a, b]$ is contained in $\mathcal{L}_{k+k'}(\Sigma, n)/C_l$. \square

Proof of 6 of Theorem 5.4 The subgroup $\mathcal{L}_k(\Sigma, n)/C_l$ is normal in the subgroup $\mathcal{L}_1(\Sigma, n)/C_l$ since for $a \in \mathcal{L}_k(\Sigma, n)/C_l$ and $b \in \mathcal{L}_1(\Sigma, n)/C_l$, we have

$b^{-1}ab = a[a, b] \in (\mathcal{L}_k(\Sigma, n)/C_l)(\mathcal{L}_{k+1}(\Sigma, n)/C_l) = \mathcal{L}_k(\Sigma, n)/C_l$. From this fact and the fact that every n -string link γ is C_1 -equivalent to a pure braid in $\Sigma \times [0, 1]$, we have only to show that $\mathcal{L}_k(\Sigma, n)/C_l$ is closed under conjugation of every element in $\mathcal{L}(\Sigma, n)/C_l$ which is represented by a pure braid. Let $a = [\alpha]_{C_l} \in \mathcal{L}(\Sigma, n)/C_l$ be an element represented by a pure braid α and let $b = [1_n^T]_{C_l}$ be an element of $\mathcal{L}_k(\Sigma, n)/C_l$, where T is a simple strict forest clasper of degree k for 1_n . Then the pair $(\alpha^{-1}1_n\alpha, T)$ is ambient isotopic relative to endpoints to a pair $(1_n, T')$, where α^{-1} is the inverse pure braid of α , and T' is a simple strict forest clasper of degree k for 1_n . Hence we have $a^{-1}ba = [1_n^{T'}]_{C_l} \in \mathcal{L}_k(\Sigma, n)/C_l$. \square

Remark 5.9 Clearly, we can extend the pure braid group action on the subgroup $\mathcal{L}_k(\Sigma, n)/C_l$ which appears in the proof of 6 of Theorem 5.4 to a mapping class group action. It is also clear that the filtration (5) is invariant under this mapping class group action.

5.3 Lower central series of pure braid groups and groups of string links

Let $P_1(\Sigma, n)$ denote the subgroup of the pure braid group $P(\Sigma, n)$ consisting of equivalence classes of pure braids which are C_1 -equivalent to the trivial string link 1_n (ie, homotopically trivial), ie, $P_1(\Sigma, n) = P(\Sigma, n) \cap \mathcal{L}_1(\Sigma, n)$. Let

$$P_1(\Sigma, n) \supset P_2(\Sigma, n) \supset P_3(\Sigma, n) \supset \dots \tag{7}$$

be the lower central series of $P_1(\Sigma, n)$, which is defined by

$$P_k(\Sigma, n) = [P_{k-1}(\Sigma, n), P_1(\Sigma, n)]$$

for $k \geq 2$. The following comes from Theorem 5.4.

Proposition 5.10 For each $k \geq 1$, we have $P_k(\Sigma, n) \subset \mathcal{L}_k(\Sigma, n)$. In other words, every commutator of class k of homotopically trivial pure braids in $\Sigma \times [0, 1]$ is C_k -equivalent to 1_n .

Now recall the definition of Stanford's equivalence relation of links using lower central series subgroup of the (usual) pure braid group $P(D^2, n)$ [44].

Definition 5.11 Let M be a 3-manifold. We say that two links γ and γ' are related by an element $b = [\beta] \in P(D^2, n)$ if there is an embedding $i: D^2 \times [0, 1] \rightarrow M$ such that $i^{-1}(\gamma) = 1_n$ and $i^{-1}(\gamma') = \beta$ as non-oriented string links or, equivalently, as sets. We say that two links γ and γ' are P'_k -equivalent if γ and γ' are related by an element of the k th lower central series subgroup $P_k(D^2, n)$ of $P(D^2, n)$ for some $n \geq 0$.

We can verify that P'_k -equivalence is actually an equivalence relation using the fact that a pure braid in $D^2 \times [0, 1]$ is a trivial tangle and also the fact that an element in $P_k(D^2, n)$ and an element in $P_k(D^2, n')$ ($n, n' \geq 0$) placed ‘side by side’ form an element of $P_k(D^2, n + n')$.

The following theorem is a characterization of C_k -equivalence in terms of pure braid commutators.

Theorem 5.12 *Let $k \geq 0$ and let γ and γ' be two links in a 3-manifold M . Then γ and γ' are C_k -equivalent if and only if they are P'_k -equivalent.*

Proof That C_k -equivalence implies P'_k -equivalence follows from Lemma 3.20. That P'_k -equivalence implies C_k -equivalence follows from Proposition 5.10. \square

Remark 5.13 We will prove in a future paper that the variant of P'_k -equivalence which uses oriented pure braids in $D^2 \times [0, 1]$ instead of non-oriented ones, which we call “ P_k -equivalence”, is equal to the P'_k -equivalence and hence to the C_k -equivalence. For knots in S^3 , this is derived from a recent result of Stanford [45].

Remark 5.14 One can redefine the notion of P_k -equivalence and P'_k -equivalence using the lower central series of $P_1(\Sigma, n)$ for connected oriented surface Σ . However, it may be more interesting to use the lower central series of $P(\Sigma, n)$, instead. Equivalence relations thus obtained are equivalent to equivalence relations defined using “admissible graph claspers,” see Section 8. 3.

5.4 Graded Lie algebras of string links

Let $\hat{\mathcal{L}}(\Sigma, n) = \varprojlim_l \mathcal{L}(\Sigma, n)/C_l$ and $\hat{\mathcal{L}}_k(\Sigma, n) = \varprojlim_l \mathcal{L}_k(\Sigma, n)/C_l$ ($k \geq 1$) be projective limits of groups. There is a descending filtration of groups

$$\hat{\mathcal{L}}(\Sigma, n) \supset \hat{\mathcal{L}}_1(\Sigma, n) \supset \hat{\mathcal{L}}_2(\Sigma, n) \supset \dots$$

By construction we have $\bigcap_{k=1}^{\infty} \hat{\mathcal{L}}_k(\Sigma, n) = \{1\}$. The natural map $\mathcal{L}(\Sigma, n) \rightarrow \hat{\mathcal{L}}(\Sigma, n)$ is injective if and only if Conjecture 3.9 holds for n -string links in $\Sigma \times [0, 1]$. If this is the case, we may think of the group $\hat{\mathcal{L}}(\Sigma, n)$ as a *completion* of the monoid $\mathcal{L}(\Sigma, n)$. However, at present, we can only say here that $\hat{\mathcal{L}}(\Sigma, n)$ is a completion of the monoid $\mathcal{L}(\Sigma, n)/C_{\infty}$ of C_{∞} -equivalence classes of n -string links in $\Sigma \times [0, 1]$.

By Theorem 5.4, we have $[\hat{\mathcal{L}}_k(\Sigma, n), \hat{\mathcal{L}}_{k'}(\Sigma, n)] \subset \hat{\mathcal{L}}_{k+k'}(\Sigma, n)$ for $k, k' \geq 1$. Hence the filtration

$$\hat{\mathcal{L}}_1(\Sigma, n) \supset \hat{\mathcal{L}}_2(\Sigma, n) \supset \dots$$

yields the associated graded Lie algebra $\bigoplus_{k=1}^{\infty} \hat{\mathcal{L}}_k(\Sigma, n)/\hat{\mathcal{L}}_{k+1}(\Sigma, n)$ with Lie bracket

$$[\cdot, \cdot]: \hat{\mathcal{L}}_k(\Sigma, n)/\hat{\mathcal{L}}_{k+1}(\Sigma, n) \times \hat{\mathcal{L}}_{k'}(\Sigma, n)/\hat{\mathcal{L}}_{k'+1}(\Sigma, n) \rightarrow \hat{\mathcal{L}}_{k+k'}(\Sigma, n)/\hat{\mathcal{L}}_{k+k'+1}(\Sigma, n)$$

($k, k' \geq 1$) which maps the pair of the coset of a and the coset of b into the coset of the commutator $a^{-1}b^{-1}ab$.

Observe that the quotient group $\hat{\mathcal{L}}_k(\Sigma, n)/\hat{\mathcal{L}}_{k+1}(\Sigma, n)$ is naturally isomorphic to $\bar{\mathcal{L}}_k(\Sigma, n)$. Therefore the above graded Lie algebra structure defines that on the graded abelian group $\bar{\mathcal{L}}(\Sigma, n) = \bigoplus_{k=1}^{\infty} \bar{\mathcal{L}}_k(\Sigma, n)$. The Lie bracket

$$[\cdot, \cdot]: \bar{\mathcal{L}}_k(\Sigma, n) \times \bar{\mathcal{L}}_{k'}(\Sigma, n) \rightarrow \bar{\mathcal{L}}_{k+k'}(\Sigma, n)$$

is given by $[[\gamma]_{C_{k+1}}, [\gamma']_{C_{k'+1}}] = [\bar{\gamma}\bar{\gamma}'\gamma\gamma']_{C_{k+k'+1}}$ for two n -string links $\gamma \underset{C_k}{\sim} 1_n$ and $\gamma' \underset{C_{k'}}{\sim} 1_n$, where $\bar{\gamma}$ (resp. $\bar{\gamma}'$) is an n -string link that is inverse to γ (resp. γ') up to C_{k+1} (resp. $C_{k'+1}$)-equivalence.

There is a natural action of $\mathcal{L}(\Sigma, n)/C_1 \cong (\pi_1 \Sigma)^n$ on the graded Lie algebra $\bar{\mathcal{L}}(\Sigma, n)$ via conjugation.

The lower central series (7) yields the associated graded Lie algebra $\bar{P}(\Sigma, n) = \bigoplus_{k=1}^{\infty} \bar{P}_k(\Sigma, n)$, where $\bar{P}_k(\Sigma, n) = P_k(\Sigma, n)/P_{k+1}(\Sigma, n)$. There is an obvious homomorphism of graded Lie algebras

$$i_*: \bar{P}(\Sigma, n) \rightarrow \bar{\mathcal{L}}(\Sigma, n). \tag{8}$$

Remark 5.15 The map i_* is far from surjective if $n \geq 1$, as will be clear in later sections. If $\Sigma = D^2$, then the map i_* is injective. We can prove this injectivity using results in the next section as follows. Suppose that a pure braid β in $P_k(D^2, n)$ satisfies $\beta \underset{C_{k+1}}{\sim} 1_n$. We must show that $\beta \in P_{k+1}(D^2, n)$. By Theorem 6.8, β is V_k -equivalent to 1_n , ie, β is not distinguished from 1_n by any invariants of type k . By a theorem of T Kohno [27], we have $\beta \in P_{k+1}(D^2, n)$. This completes the proof of injectivity.

Conjecture 5.16 *The homomorphism $i_*: \bar{P}(\Sigma, n) \rightarrow \bar{\mathcal{L}}(\Sigma, n)$ of graded Lie algebras is injective.*

6 Vassiliev–Goussarov filtrations

6.1 Usual definition of the Vassiliev–Goussarov filtration

First we recall the usual definition of the Vassiliev–Goussarov filtration using singular links. For details, see [4] and [1].

Definition 6.1 A *singular link* γ in a 3–manifold M of pattern $P = (\alpha, i: \partial\alpha \hookrightarrow \partial M)$ is a proper immersion of the 1–manifold α into M restricting to i on boundary such that the singularity set consists of finitely many transverse double points. The image of γ is also called a singular link of pattern P , and denoted by γ . A *component* of γ is the image of a connected component of α by γ . It may happen that two distinct components of γ are contained in the same connected component of γ .

Two singular links γ and γ' of pattern P are said to be *equivalent* if they are ambient isotopic relative to endpoints.

In the following, we fix a link γ_0 in M of pattern $P = (\alpha, i)$.

As in Section 4, let $\mathcal{L}(M, \gamma_0)$ denote the set of equivalence classes of links in M which are of the same pattern with γ_0 , and, for each $k \geq 0$, let $\mathcal{L}_k(M, \gamma_0)$ denote the subset of $\mathcal{L}(M, \gamma_0)$ consisting of the equivalence classes of links which are C_k –equivalent to γ_0 . If M is clear from the context, we usually let $\mathcal{L}_k(\gamma_0)$ denote $\mathcal{L}_k(M, \gamma_0)$. Since C_1 –equivalence is just homotopy (relative to endpoints), $\mathcal{L}_1(\gamma_0)$ is the set of equivalence classes of links in M that are homotopic to γ_0 .

For each $k \geq 0$, let $\mathcal{SL}_k(M, \gamma_0) = \mathcal{SL}_k(\gamma_0)$ denote the set of equivalence classes of singular links in M equipped with just k double points, and homotopic to γ_0 .

For each $k \geq 0$, we construct a \mathbf{Z} –linear map $e: \mathbf{Z}\mathcal{SL}_k(\gamma_0) \rightarrow \mathbf{Z}\mathcal{L}_1(\gamma_0)$ as follows. Let γ be a singular link with k double points which is homotopic to γ_0 . Let p_1, \dots, p_k be the double points of γ and let $\epsilon_1, \dots, \epsilon_k \in \{+, -\}$ be signs. Let $\gamma_{(\epsilon_1, \dots, \epsilon_k)}$ denote the link in M obtained from γ by replacing each double point p_i with a crossing of sign ϵ_i . Then we set

$$e([\gamma]) = \sum_{\epsilon_1, \dots, \epsilon_k \in \{+, -\}} \epsilon_1 \cdots \epsilon_k [\gamma_{(\epsilon_1, \dots, \epsilon_k)}],$$

where $[\cdot]$ denotes equivalence class.

Let $J_k(\gamma_0)$ denote the subgroup of $\mathbf{Z}\mathcal{L}_1(\gamma_0)$ generated by the set $X_k(\gamma_0)$ consisting of the elements $e([\gamma])$, where $[\gamma] \in \mathcal{S}\mathcal{L}_k(\gamma_0)$. It is easy to see that the $J_k(\gamma_0)$'s form a descending filtration on $\mathbf{Z}\mathcal{L}_1(\gamma_0)$

$$\mathbf{Z}\mathcal{L}_1(\gamma_0) = J_0(\gamma_0) \supset J_1(\gamma_0) \supset J_2(\gamma_0) \supset \cdots, \quad (9)$$

which we call the *Vassiliev–Goussarov filtration* on $\mathbf{Z}\mathcal{L}_1(\gamma_0)$. Later, we will redefine $J_k(\gamma_0)$ using claspers.

Remark 6.2 If two links γ_0 and γ_0' are homotopic to each other, then we have $\mathcal{L}(\gamma_0) = \mathcal{L}(\gamma_0')$ and the filtration (9) is equal to the filtration

$$\mathbf{Z}\mathcal{L}_1(\gamma_0') = J_0(\gamma_0') \supset J_1(\gamma_0') \supset J_2(\gamma_0') \supset \cdots. \quad (10)$$

Remark 6.3 We may consider a similar filtration on the abelian group $\mathbf{Z}\mathcal{L}(\gamma_0)$ using singular links which are of the same pattern with γ_0 . However, this filtration is the direct sum of the filtrations on the $\mathbf{Z}\mathcal{L}_1(\gamma)$'s, where γ runs over a set of representatives of homotopy classes of links of pattern P . Hence it suffices to study filtrations on $\mathbf{Z}\mathcal{L}_1(\gamma_0)$ to study that on $\mathbf{Z}\mathcal{L}(\gamma_0)$.

Definition 6.4 Let A be an abelian group and $k \geq 0$ an integer. An A -valued *invariant of type k* on $\mathcal{L}_1(\gamma_0)$ is a homomorphism of $\mathbf{Z}\mathcal{L}_1(\gamma_0)$ into A which vanishes on $J_{k+1}(\gamma_0)$. Thus the group of A -valued type k invariants on $\mathcal{L}_1(\gamma_0)$ is isomorphic to $\text{Hom}_{\mathbf{Z}}(\mathbf{Z}\mathcal{L}_1(\gamma_0)/J_{k+1}(\gamma_0), A)$.

For $k \geq 0$, two links γ and γ' in M are said to be V_k -*equivalent*, if $[\gamma] - [\gamma'] \in J_{k+1}(\gamma_0)$, or equivalently, if γ and γ' are not distinguished by any invariants of type k with values in any abelian group.

6.2 Definition of Vassiliev–Goussarov filtrations using claspers

In the following, we first introduce a notion of “schemes” on a link in 3-manifolds. Then using them we define some filtrations on $\mathbf{Z}\mathcal{L}_1(\gamma_0)$ which will turn out to be equal to the Vassiliev–Goussarov filtration defined above.

We fix a link γ_0 in a 3-manifold M in the following.

Definition 6.5 Let $l \geq 0$ and let γ be a link in M which is homotopic to γ_0 . A *scheme of size l* , $S = \{S_1, \dots, S_l\}$, for a link γ in a 3-manifold M is a set of l disjoint claspers for γ . If S_i is a tame clasper for every $i = 1, \dots, l$, then

for each subset $S' \subset S$, the result of surgery $\gamma \cup^{S'}$ is a link in M . Define an element $[\gamma, S] = [\gamma; S_1, \dots, S_l]$ of $\mathbf{ZL}(\gamma_0)$ by

$$[\gamma, S] = \sum_{S' \subset S} (-1)^{l - \text{size}(S')} [\gamma \cup^{S'}],$$

where S' runs over all 2^l subsets of S , and $[\gamma \cup^{S'}]$ denotes the equivalence class of the result of surgery, $\gamma \cup^{S'}$.

We can easily check the following properties of the bracket notation.

- $[\gamma, \emptyset] = [\gamma;] = [\gamma]$,
- $[\gamma; S_{\sigma(1)}, \dots, S_{\sigma(l)}] = [\gamma; S_1, \dots, S_l]$, where σ is a permutation on the set $\{1, \dots, l\}$,
- $[\gamma; S_1, \dots, S_l] = [\gamma^{S_1}; S_2, \dots, S_l] - [\gamma; S_2, \dots, S_l]$,
- $[\gamma; S_{1,1} \cup \dots \cup S_{1,p}, S_2, \dots, S_l] = \sum_{j=1}^p [\gamma^{S_{1,1} \cup \dots \cup S_{1,j-1}}; S_{1,j}, S_2, \dots, S_l]$, where $S_{1,1} \cup \dots \cup S_{1,p}$ is a clasper consisting of p disjoint tame claspers $S_{1,1}, \dots, S_{1,p}$.

Definition 6.6 A *forest scheme* $S = \{S_1, \dots, S_l\}$ is a scheme consisting of strict tree claspers S_1, \dots, S_l . We say that S is *simple* if the elements S_1, \dots, S_l of S are all simple. The *degree* $\deg S$ of a forest scheme S is the sum of the degrees of its elements.

For k, l with $1 \leq l \leq k$, let $J_{k,l}(\gamma_0)$ (resp. $J_{k,l}^S(\gamma_0)$) denote the subgroup of $\mathbf{ZL}_1(\gamma_0)$ generated by the elements $[\gamma, S]$, where γ is a link in M homotopic to γ_0 and S is a forest scheme (resp. simple forest scheme) of size l for γ of degree k . Clearly, we have $J_{k,l}^S(\gamma_0) \subset J_{k,l}(\gamma_0)$.

The following theorem describes some of the inclusions of various subgroups of $\mathbf{ZL}_1(\gamma_0)$. Especially, we can redefine the subgroup $J_k(\gamma_0)$, which is previously defined using singular links, in terms forest schemes.

Theorem 6.7 *Let γ_0 be a link in a 3-manifold M . Then we have the following.*

- (1) *If $k \geq 1$, then we have $J_k(\gamma_0) = J_{k,k}^S(\gamma_0) = J_{k,k}(\gamma_0)$.*
- (2) *If $1 \leq l \leq k$, then we have $J_{k,l}^S(\gamma_0) = J_{k,l}(\gamma_0)$.*
- (3) *If $1 \leq l \leq l' \leq k$, then we have $J_{k,l}(\gamma_0) \subset J_{k,l'}(\gamma_0)$.*
- (4) *If $1 \leq l \leq k \leq k'$, then we have $J_{k',l}(\gamma_0) \subset J_{k,l}(\gamma_0)$.*

$$e \left(\left[\begin{array}{c} \diagup \quad \diagdown \\ \cdot \\ \diagdown \quad \diagup \end{array} \right] \right) = \pm \left(\left[\begin{array}{c} \diagup \quad \diagdown \\ \cdot \\ \diagdown \quad \diagup \end{array} \right] - \left[\begin{array}{c} \diagdown \quad \diagup \\ \cdot \\ \diagup \quad \diagdown \end{array} \right] \right) = \pm \left[\begin{array}{c} \circ \quad \diagdown \\ \cdot \\ \diagdown \quad \circ \end{array} \right]$$

Figure 33

Hence we may redefine $J_k(\gamma_0)$ as the submodule of $\mathbf{Z}\mathcal{L}_1(\gamma_0)$ generated by elements $[\gamma, S]$, where γ is a link in M homotopic to γ_0 and S is a (simple) forest scheme of degree k (or of degree $\geq k$).

Corollary 6.8 For $k \geq 0$, if two links γ and γ' in a 3-manifold M are C_{k+1} -equivalent, then γ and γ' are V_k -equivalent.

Proof We have only to show that if γ' is obtained from γ by surgery on a simple strict tree clasper of degree $k + 1$, then we have $[\gamma] - [\gamma'] \in J_{k+1}(\gamma_0)$. By definition, it is clear that $[\gamma] - [\gamma'] \in J_{k+1,1}^S(\gamma_0)$. By Theorem 6.7, we have $J_{k+1,1}^S(\gamma_0) \subset J_{k+1}(\gamma_0)$. Hence we have $[\gamma] - [\gamma'] \in J_{k+1}(\gamma_0)$. \square

Now we will prove Theorem 6.7. The following is the first half of the claim 1 of Theorem 6.7.

Proposition 6.9 If $k \geq 1$, then we have $J_k(\gamma_0) = J_{k,k}^S(\gamma_0)$.

Proof If $k = 1$, then the result follows from Figure 33. The general case follows from this case. \square

Proof of 2 of Theorem 6.7 It suffices to show that $J_{k,l}(\gamma_0) \subset J_{k,l}^S(\gamma_0)$. Let γ be a link in M homotopic to γ_0 and let $S = \{S_1, \dots, S_l\}$ be a forest scheme of size l for γ of degree k . For each $i = 1, \dots, l$, let N_i be a small regular neighborhood of S_i in M such that ∂N_i is transverse to γ . By Theorem 3.17, there are finitely many disjoint simple strict tree claspers $T_{i,1}, \dots, T_{i,p_i}$ ($p_i \geq 0$) for $\gamma \cap N_i$ in N_i of degree $\deg S_i$ such that $(\gamma \cap N_i)^{T_{i,1} \cup \dots \cup T_{i,p_i}} \cong (\gamma \cap N_i)^{S_i}$, and hence $\gamma^{T_{i,1} \cup \dots \cup T_{i,p_i} \cup G} \cong \gamma^{S_i \cup G}$ for any tame clasper G for γ which is disjoint from N_i . Therefore we have $[\gamma; S_1, \dots, S_l] = [\gamma; T_{1,1} \cup \dots \cup T_{1,p_1}, \dots, T_{l,1} \cup \dots \cup T_{l,p_l}] = \sum_{j_1=1}^{p_1} \dots \sum_{j_l=1}^{p_l} [\gamma^{\cup_{1 \leq i \leq l} \cup_{1 \leq j \leq j_i} T_{i,j}}; T_{1,j_1}, \dots, T_{l,j_l}] \in J_{k,l}^S(\gamma_0)$. \square

Proof of 1 of Theorem 6.7 The first half is Proposition 6.9. The rest comes from the claim 2. \square

Proof of 3 of Theorem 6.7 For k, l with $1 \leq l \leq k - 1$, we have only to prove that $J_{k,l}(\gamma_0) \subset J_{k,l+1}(\gamma_0)$.

By the claim 2, it suffices to show that, for a simple forest scheme $S = \{S_1, \dots, S_l\}$ of size l of degree k for a link γ in M with $[\gamma] \in \mathcal{L}_1(\gamma_0)$, we have $[\gamma, S] \in J_{k,l+1}(\gamma_0)$. By hypothesis, there is an element, say S_1 , of S of degree ≥ 2 . Let V be a node of S_1 adjacent to at least one disk-leaf. Applying move 9 and ambient isotopy to the simple strict tree clasper S_1 and the node V , we obtain two disjoint strict tree claspers $S_{1,1}$ and $S_{1,2}$ for γ in a small regular neighborhood N of S_1 in M such that

- (1) $\deg S_{1,1} + \deg S_{1,2} = \deg S_1$,
- (2) $\gamma_N \cong \gamma_N^{S_{1,1}} \cong \gamma_N^{S_{1,2}}$,
- (3) $\gamma_N^{S_{1,1} \cup S_{1,2}} \cong \gamma_N^{S_1}$,

where γ_N denotes the link $\gamma \cap N$ in N . Hence we have $[\gamma_N; S_1] = [\gamma_N; S_{1,1} \cup S_{1,2}] = [\gamma_N^{S_{1,1} \cup S_{1,2}}] - [\gamma_N] = [\gamma_N^{S_{1,1} \cup S_{1,2}}] - [\gamma_N^{S_{1,1}}] - [\gamma_N^{S_{1,2}}] + [\gamma_N] = [\gamma_N; S_{1,1}, S_{1,2}]$.

Therefore $[\gamma, S] = [\gamma; S_1, S_2, \dots, S_l] = [\gamma; S_{1,1}, S_{1,2}, S_2, \dots, S_l] \in J_{k,l+1}(\gamma_0)$. \square

Proof of 4 of Theorem 6.7 We have to prove that if $1 \leq l \leq k$, then $J_{k+1,l}(\gamma_0) \subset J_{k,l}(\gamma_0)$.

It suffices to show that, for a link γ in M and a simple forest scheme $S = \{S_1, \dots, S_l\}$ of size l for γ of degree $k + 1$, we have $[\gamma, S] \in J_{k,l}(\gamma_0)$. There is at least one element, say S_1 , of S with degree ≥ 2 . By Proposition 3.7 and Theorem 3.17, there is a strict tree clasper S'_1 of degree $\deg S_1 - 1$ for γ contained in a small regular neighborhood N of S_1 in M such that $\gamma_N^{S_1} \cong \gamma_N^{S'_1}$, where $\gamma_N = \gamma \cap N$. Hence we have $[\gamma, S] = [\gamma; S_1, \dots, S_l] = [\gamma; S'_1, S_2, \dots, S_l] \in J_{k,l}(\gamma_0)$. \square

6.3 Vassiliev–Goussarov filtrations on string links

In this section we study the Vassiliev–Goussarov filtration on n -string links in $\Sigma \times [0, 1]$, where $n \geq 0$ and Σ is a connected oriented surface. For $k \geq 0$, we set $J_k(\Sigma, n) = J_k(\Sigma \times [0, 1], 1_n)$. This defines a descending sequence of two-sided ideals of the monoid ring $\mathbf{Z}\mathcal{L}_1(\Sigma, n)$

$$\mathbf{Z}\mathcal{L}_1(\Sigma, n) = J_0(\Sigma, n) \supset J_1(\Sigma, n) \supset \dots$$

We also set $J_{k,l}(\Sigma, n) = J_{k,l}(\Sigma \times [0, 1], 1_n)$. As an alternative, we may define $J_k(\Sigma, n)$ (resp. $J_{k,l}(\Sigma, n)$) to be the subgroup of $\mathbf{Z}\mathcal{L}_1(\Sigma, n)$ generated by the

set of the elements $[\gamma, S]$, where γ is a homotopically trivial n -string link and S is a forest scheme (resp. a forest scheme of size l) for γ of degree k . (We may assume that S is simple. See Theorem 6.7.)

As we can easily see, $J_{k,l}(\Sigma, n)$ (and hence $J_k(\Sigma, n)$) is a two-sided ideal in the monoid ring $\mathbf{Z}\mathcal{L}_1(\Sigma, n)$. Moreover we have

$$J_{k,l}(\Sigma, n)J_{k',l'}(\Sigma, n) \subset J_{k+k',l+l'}(\Sigma, n)$$

and, especially, $J_k(\Sigma, n)J_{k'}(\Sigma, n) \subset J_{k+k'}(\Sigma, n)$. Observe that $J_1(\Sigma, n)$ is the augmentation ideal of the monoid ring $\mathbf{Z}\mathcal{L}_1(\Sigma, n)$, ie,

$$J_1(\Sigma, n) = \ker(\epsilon: \mathbf{Z}\mathcal{L}_1(\Sigma, n) \rightarrow \mathbf{Z}),$$

where ϵ is given by $\epsilon([\gamma]) = 1$ for every $[\gamma] \in \mathcal{L}_1(\Sigma, n)$.

For two schemes $S = \{S_1, \dots, S_l\}$ and $S' = \{S'_1, \dots, S'_{l'}\}$ for n -string links γ and γ' , respectively, let $S \cdot S'$ denote the scheme of size $l+l'$ for the composition $\gamma\gamma'$ defined by $S \cdot S' = h_0(S) \cup h_1(S')$, where $h_0, h_1: \Sigma \times [0, 1] \hookrightarrow \Sigma \times [0, 1]$ are as in (4).

For k, l with $1 \leq l \leq k$, we set

$$J_k^{(l)}(\Sigma, n) = \sum_{\substack{k_1, \dots, k_l \geq 1 \\ k_1 + \dots + k_l = k}} J_{k_1,1}(\Sigma, n) \cdots J_{k_l,1}(\Sigma, n).$$

Proposition 6.10 *If $k \geq 1$, then*

$$J_k(\Sigma, n) \subset \sum_{l=1}^k J_k^{(l)}(\Sigma, n). \tag{11}$$

Proof The proof is by induction on k . If $k = 1$, then (11) clearly holds. Let $k \geq 2$ and assume that (11) holds for smaller k . In this proof, we set $N_k = \sum_{l=1}^k J_k^{(l)}(\Sigma, n)$. It suffices to prove the following claim.

Claim Let $S = \{S_1, \dots, S_m\}$ be a simple strict forest scheme of size m of degree k for a homotopically trivial n -string link γ . Then we have $[\gamma, S] \in N_k$.

The proof of the claim is by induction on m . If $m = 1$, then $[\gamma, S] \in J_{k,1}(\Sigma, n) \subset N_k$. Let $m \geq 2$ and assume that the claim holds for smaller m .

We first prove that we may assume $\gamma = 1_n$. By Theorem 5.4, there is an n -string link $\bar{\gamma}$ which is inverse to γ up to C_k -equivalence. Hence there is

a simple strict forest clasper $T = T_1 \cup \cdots \cup T_q$ for $\bar{\gamma}\gamma$ of degree k such that T is disjoint from $\emptyset \cdot S$ and such that $(\bar{\gamma}\gamma)^T \cong 1_n$. Since $\bar{\gamma}$ is C_1 -equivalent to 1_n , there is, by Theorem 3.17, a simple strict forest clasper $C = C_1 \cup \cdots \cup C_p$ of size p for 1_n of degree 1 such that $1_n^C \cong \bar{\gamma}$. We have $[\gamma, S] = [1_n][\gamma, S] = [\bar{\gamma}][\gamma, S] - ([\bar{\gamma}] - [1_n])[\gamma, S] = [\bar{\gamma}\gamma, \emptyset \cdot S] - [1_n; C][\gamma, S] = [(\bar{\gamma}\gamma)^T; \emptyset \cdot S] - [\bar{\gamma}\gamma, \{T\} \cup (\emptyset \cdot S)] - [1_n; C][\gamma, S]$. It is clear that $[\bar{\gamma}\gamma, \{T\} \cup (\emptyset \cdot S)] \in J_{k,1}(\Sigma, n)$. We have also $[1_n; C][\gamma, S] \in J_1(\Sigma, n)J_k(\Sigma, n) \subset J_1(\Sigma, n)J_{k-1}(\Sigma, n)$. By the induction hypothesis, we have $J_{k-1}(\Sigma, n) \subset N_{k-1}$. Hence $[1_n; C][\gamma, S] \in J_{1,1}(\Sigma, n)N_{k-1} \subset N_k$. Therefore we have only to show that $[(\bar{\gamma}\gamma)^T; \emptyset \cdot S] \in N_k$. This means that we have to prove the claim only in the case that $\gamma = 1_n$.

Assume that $\gamma = 1_n$. By ambient isotopy, we may assume that $S_1, \dots, S_m \subset \Sigma \times [\frac{1}{2}, 1]$. There is a sequence of simple strict tree claspers $S_{1,0}, \dots, S_{1,r}$ ($r \geq 0$) for 1_n of degree $k_1 = \deg S_1$ satisfying the following conditions.

- (1) $S_{1,0} = S_1, \quad S_{1,r} \subset [0, \frac{1}{2}]$.
- (2) $S_{1,i}$ is disjoint from S_2, \dots, S_m for $i = 0, \dots, r$.
- (3) For each $i = 0, \dots, r-1$, S_i and S_{i+1} are related by one of the following operations:
 - (a) ambient isotopy fixing $S_2 \cup \cdots \cup S_m$ pointwise and 1_n as a set,
 - (b) sliding a disk-leaf of $S_{1,i}$ over a disk-leaf of some S_j ($2 \leq j \leq m$),
 - (c) passing an edge of $S_{1,i}$ across an edge of some S_j ($2 \leq j \leq m$).

We set $d_i = [1_n; S_{1,i+1}, S_2, \dots, S_m] - [1_n; S_{1,i}, S_2, \dots, S_m]$ for $i = 0, 1, \dots, r-1$. We must show that d_0, \dots, d_{r-1} and $[1_n; S_{1,r}, S_2, \dots, S_m]$ are contained in N_k . Since $S_{1,r} \subset [0, \frac{1}{2}]$ and $S_2, \dots, S_m \subset [\frac{1}{2}, 1]$, we have $[1_n; S_{1,r}, S_2, \dots, S_m] = [1_n; S_{1,r}][1_n; S_2, \dots, S_m] \in J_{k_1,1}(\Sigma, n)J_{k-k_1}(\Sigma, n)$. By hypothesis, $J_{k-k_1}(\Sigma, n)$ is contained in N_{k-k_1} . Hence $[1_n; S_{1,r}, S_2, \dots, S_m] \in N_k$. Now it suffices to show that $d_i \in N_k$ in each of the three cases a, b and c above.

Case (a) We clearly have $d_i = 0$.

Case (b) Suppose that $S_{1,i+1}$ is obtained from $S_{1,i}$ by sliding a disk-leaf D_1 of $S_{1,i}$ over a disk-leaf D_2 of S_j ($2 \leq j \leq l$). We may assume $j = 2$ without loss of generality. Let $c \subset 1_n$ be the segment in 1_n bounded by $D_1 \cap 1_n, D_2 \cap 1_n$, along which the slide occurs, and let N be a small regular neighborhood of $S_{1,i} \cup S_2 \cup c$, with ∂N transverse to 1_n . We may assume that $S_{1,i+1} \subset \text{int}N$. By Proposition 4.4 and Theorem 3.17, there is a simple strict tree clasper T for $\gamma_N = 1_n \cap N$ of degree $k_1 + k_2$ disjoint from $S_{1,i} \cup S_2$ such that $\gamma_N^{S_{1,i+1} \cup S_2} \cong \gamma_N^{S_{1,i} \cup S_2 \cup T}$. Hence $[\gamma_N; S_{1,i+1}, S_2] - [\gamma_N; S_{1,i}, S_2] = ([\gamma_N^{S_{1,i+1} \cup S_2}] - [\gamma_N^{S_{1,i+1}}] - [\gamma_N^{S_2}] + [\gamma_N]) - ([\gamma_N^{S_{1,i} \cup S_2}] - [\gamma_N^{S_{1,i}}] - [\gamma_N^{S_2}] +$

$[\gamma_N] = [\gamma_N^{S_{1,i} \cup S_2 \cup T}] - [\gamma_N^{S_{1,i} \cup S_2}] = [\gamma_N^{S_{1,i} \cup S_2}; T]$. Therefore we have $d_i = [1_n^{S_{1,i} \cup S_2}; T, S_3, \dots, S_m] \in N_k$ by the induction hypothesis.

Case (c) Suppose that $S_{1,i+1}$ is obtained from $S_{1,i}$ by a crossing change of an edge of $S_{1,i}$ and an edge of S_j ($2 \leq j \leq m$). We may assume $j = 2$ without loss of generality. Let B be a small 3-ball in $\text{int}(\Sigma \times [0, 1])$ in which the crossing change occurs, and let N be a small regular neighborhood of $B \cup S_{1,i}$ in $\Sigma \times [0, 1]$ with ∂N transverse to 1_n . We may assume that $S_{1,i+1} \subset \text{int}N$. By Proposition 4.6 and Theorem 3.17, there is a simple strict tree clasper T for $\gamma_N = 1_n \cap N$ of degree $k_1 + k_2 + 1$ disjoint from $S_{1,i}$ and S_2 such that $\gamma_N^{S_{1,i+1} \cup S_2} \cong \gamma_N^{S_{1,i} \cup S_2 \cup T_0}$. Modifying T_0 by move 10, we obtain a simple strict tree clasper T in a small regular neighborhood of T_0 for γ_N of degree $k_1 + k_2$ such that $\gamma_N^{S_{1,i+1} \cup S_2} \cong \gamma_N^{S_{1,i} \cup S_2 \cup T}$. Then we can check $d_i \in N_k$ as in the case b. \square

Theorem 6.11 *If $n \geq 0$ and if Σ is a connected oriented surface, then we have*

$$\bigcap_{k=0}^{\infty} J_k(\Sigma, n) = \bigcap_{k=1}^{\infty} J_{k,1}(\Sigma, n) = J_{\infty,1}(\Sigma, n). \quad (12)$$

Here $J_{\infty,1}(\Sigma, n)$ is the subgroup of $\mathbf{Z}\mathcal{L}_1(\Sigma, n)$ generated by the elements of the form $[\gamma] - [\gamma']$, where γ and γ' are C_{∞} -equivalent.

Proof It is clear that $\bigcap_{k=1}^{\infty} J_{k,1}(\Sigma, n) \subset \bigcap_{k=0}^{\infty} J_k(\Sigma, n)$. We will prove the reverse inclusion. We must show that, for each $k \geq 1$, we have $\bigcap_{k=0}^{\infty} J_k(\Sigma, n) \subset J_{k,1}(\Sigma, n)$.

Let $i: \mathbf{Z}\mathcal{L}_1(\Sigma, n)/J_{k,1}(\Sigma, n) \xrightarrow{\cong} \mathbf{Z}(\mathcal{L}_1(\Sigma, n)/C_k)$ be the obvious isomorphism of rings. Let J denote the augmentation ideal of the group ring $\mathbf{Z}(\mathcal{L}_1(\Sigma, n)/C_k)$. For each $l \geq 1$, we have $i^{-1}(J^l) = (J_1(\Sigma, n)^l + J_{k,1}(\Sigma, n))/J_{k,1}(\Sigma, n)$. Since J is the augmentation ideal of the group ring of the nilpotent group $\mathcal{L}_1(\Sigma, n)/C_k$, we have $\bigcap_{l=0}^{\infty} J^l = \{0\}$. Hence we have $\bigcap_{l=0}^{\infty} ((J_1(\Sigma, n)^l + J_{k,1}(\Sigma, n))/J_{k,1}(\Sigma, n)) = \{0\}$. This implies that $\bigcap_{l=0}^{\infty} (J_1(\Sigma, n)^l + J_{k,1}(\Sigma, n)) \subset J_{k,1}(\Sigma, n)$. Hence we have $\bigcap_{l=1}^{\infty} J_l(\Sigma, n) \subset \bigcap_{l=1}^{\infty} J_{kl}(\Sigma, n) \subset \bigcap_{l=1}^{\infty} \sum_{i=1}^{kl} J_{kl}^{(i)}(\Sigma, n) \subset \bigcap_{l=1}^{\infty} (J_1(\Sigma, n)^l + J_{k,1}(\Sigma, n)) \subset J_{k,1}(\Sigma, n)$.

The equality $\bigcap_{k=1}^{\infty} J_{k,1}(\Sigma, n) = J_{\infty,1}(\Sigma, n)$ is obvious. \square

Corollary 6.12 *Two n -string links in $\Sigma \times [0, 1]$ are C_{∞} -equivalent to each other if and only if they are not distinguished by any finite type invariants.*

Conjecture 6.13 *Let Σ be a connected oriented surface and let $n, k \geq 0$. Then two n -string links in $\Sigma \times [0, 1]$ are C_{k+1} -equivalent if and only if they are V_k -equivalent.*

If Conjecture 6.13 holds, then Theorem 6.11 can be proved as a corollary to Conjecture 6.13.

6.4 Vassiliev–Goussarov filtrations on string knots

Definition 6.14 *A string knot will mean a 1-string link in the cylinder $D^2 \times [0, 1]$. Let $\mathcal{L}(1) = \mathcal{L}_1(1)$ denote the commutative monoid $\mathcal{L}(D^2, 1) = \mathcal{L}_1(D^2, 1)$ of string knots.*

There is a natural isomorphism between the monoid $\mathcal{L}(1)$ and the monoid of equivalence classes of knots in S^3 with multiplication induced by the connected sum operation. Therefore all results about string knots in the rest of this section can be directly restated for knots in S^3 .

Definition 6.15 *A \mathbf{Z} -linear map $v: \mathbf{Z}\mathcal{L}(1) \rightarrow A$, where A is an abelian group, is additive (or primitive) if $v([1_1]) = 0$ and $v(J_1(1)J_1(1)) = 0$.*

Since the augmentation ideal $J_1(1)$ of $\mathbf{Z}\mathcal{L}(1)$ is spanned by $\{[\gamma] - [1_1] \mid [\gamma] \in \mathcal{L}(1)\}$, the condition that $v(J_1(1)J_1(1)) = 0$ is equivalent to $v([\gamma] - [1_1])([\gamma'] - [1_1]) = 0$, and hence to $v([\gamma\gamma']) - v([\gamma]) - v([\gamma']) + v([1_1]) = 0$ for any two string knots γ and γ' . This is equivalent to $v([\gamma\gamma']) = v([\gamma]) + v([\gamma'])$ by the first condition. Conversely, $v([\gamma\gamma']) = v([\gamma]) + v([\gamma'])$ implies the additivity of v . In other words, v is additive if and only if v restricts to a homomorphism $\mathcal{L}(1) \rightarrow A$ of commutative monoids.

Let $\psi_k: \mathbf{Z}\mathcal{L}(1) \rightarrow \mathcal{L}(1)/C_{k+1}$ ($k \geq 0$) be the homomorphism of abelian groups defined by $\psi_k([\gamma]) = [\gamma]_{C_{k+1}}$ for each string knot γ , where $[\gamma]_{C_{k+1}}$ denotes the C_{k+1} -equivalence class of γ . (ψ_k is a homomorphism of an additive group into a multiplicative group.)

Proposition 6.16 *For each $k \geq 0$, the homomorphism ψ_k is an additive invariant of type k .*

Proof For two string knots γ and γ' , we have

$$\psi_k([\gamma\gamma'] - [\gamma] - [\gamma']) = [\gamma\gamma']_{C_{k+1}} [\gamma]_{C_{k+1}}^{-1} [\gamma']_{C_{k+1}}^{-1} = [1_1]_{C_{k+1}}.$$

Hence ψ_k is additive.

Now we prove that ψ_k is of type k , ie, $\psi_k(J_{k+1}(1)) = \{1\}$. By Proposition 6.10, we have $J_{k+1}(1) \subset J_{k+1,1}(1) + J_1(1)J_1(1)$. Clearly, ψ_k vanishes on $J_{k+1,1}(1)$. By the additivity of ψ_k proved above, ψ_k vanishes also on $J_1(1)J_1(1)$. Hence ψ_k is of type k . \square

Theorem 6.17 *For $k \geq 1$, ψ_k is universal in that for any additive invariant $v: \mathbf{Z}\mathcal{L}(1) \rightarrow A$ of type k with values in any abelian group A , there is a unique homomorphism $\bar{v}: \mathcal{L}(1)/C_{k+1} \rightarrow A$ such that $v = \bar{v}\psi_k$.*

Proof Let $v: \mathbf{Z}\mathcal{L}(1) \rightarrow A$ be an additive invariant of type k with A an abelian group. First we prove the uniqueness of \bar{v} . Suppose that $\bar{v}, \bar{v}': \mathcal{L}(1)/C_{k+1} \rightarrow A$ are two homomorphisms with $v = \bar{v}\psi_k = \bar{v}'\psi_k$. Then, for each string knot γ , we have $\bar{v}([\gamma]_{C_{k+1}}) = \bar{v}\psi_k([\gamma]) = \bar{v}'\psi_k([\gamma]) = \bar{v}'([\gamma]_{C_{k+1}})$. Hence $\bar{v} = \bar{v}'$. Next we prove the existence of \bar{v} . By the additivity of v , the restriction $v|_{\mathcal{L}(1)}: \mathcal{L}(1) \rightarrow A$ is a homomorphism of monoids. The restriction $v|_{\mathcal{L}(1)}$ factors through $\psi_k|_{\mathcal{L}(1)} = \text{proj}: \mathcal{L}(1) \rightarrow \mathcal{L}(1)/C_{k+1}$, since if two string knots γ and γ' are C_{k+1} -equivalent, then we have $v([\gamma]) = v([\gamma'])$. Hence there is a homomorphism $\bar{v}: \mathcal{L}(1)/C_{k+1} \rightarrow A$ such that $\bar{v}(\psi_k|_{\mathcal{L}(1)}) = v|_{\mathcal{L}(1)}$, and hence such that $\bar{v}\psi_k = v$. \square

The following theorem gives a characterization of the information carried by invariants of type k in terms of C_{k+1} -equivalence.

Theorem 6.18 *If $k \geq 0$ and if γ and γ' are string knots, then the following conditions are equivalent.*

- (1) γ and γ' are C_{k+1} -equivalent.
- (2) γ and γ' are P'_{k+1} -equivalent.
- (3) γ and γ' are V_k -equivalent, ie, γ and γ' are not distinguished by any invariant of type k with values in any abelian group.
- (4) γ and γ' are not distinguished by any additive invariant of type k with values in any abelian group.

Similar equivalence holds also for knots in S^3 .

Proof By Theorem 5.12, 1 and 2 are equivalent. By Corollary 6.8, 1 implies 3. It is clear that 3 implies 4. By Theorem 6.17, 4 is equivalent to $\psi_k([\gamma]) = \psi_k([\gamma'])$. This implies $[\gamma]_{C_{k+1}} = [\gamma']_{C_{k+1}}$, and hence the condition 1. \square

Remark 6.19 That 2 implies 3 is due to T Stanford [44]. The above proof using claspers provides another (very indirect) proof of this.

After a previous version of this paper [20] was circulated, T Stanford proved that two knots in S^3 are V_k -equivalent if and only if they are represented as two closed braids of the same number of strands which differ only by an element of the $k + 1$ st lower central series subgroup of the pure braid group [45]. The equivalence of 2 and 3 in Theorem 6.18 can be also derived from this result of Stanford. That 3 is equivalent to 4 is due to Stanford [45].

The techniques used in [45] deeply involves commutator calculus on the pure braid groups and, at first sight, they may look very different from the techniques used in this paper (and in [20]). However, they are related to each other in some deep sense. Stanford's proof involves commutator calculus on pure braid groups, while our proof implicitly involves commutator calculus on a Hopf algebra in a category of 3-dimensional cobordisms. See Section 8.1 for more details.

Remark 6.20 Since a rational invariant of type k is a sum of an additive invariant of type k and a polynomial of invariants of degree $< k$ [28] [1], the conditions 3 and 4 above are equivalent for rational finite type invariants. This fact is noted in [45].

Remark 6.21 It is well known that there is an algorithm to determine whether or not two given knots γ and γ' in S^3 are V_k -equivalent for a given integer $k \geq 0$. This algorithm also works to determine whether or not two knots in S^3 are C_{k+1} -equivalent for $k \geq 0$.

7 Examples and remarks

In this section we give some examples of C_k -moves and also give some remarks.

7.1 Simple C_k -moves as band-sum operations

As we have already seen, a simple C_1 -move is equivalent to a crossing change. It is also equivalent to band-summing a Hopf link L_2 , see Figure 34a. Hence any two knots in S^3 are C_1 -equivalent to each other. On the other hand, any invariant of knots in S^3 of type 0 with values in any abelian group is a constant function.

A simple C_2 -move is equivalent to band-summing the Borromean rings L_3 , see Figure 34b. This operation has appeared in many places: [40], [35], [42], [12], etc. H Murakami and Y Nakanishi proved that any two knots in S^3 are related by a sequence of operations of this kind, which they call “ Δ -unknotting operations” [40]. On the other hand, any knot invariant of type 1 with values in any abelian group is again a constant function.

A simple C_3 -move is equivalent to band-summing Milnor’s link L_4 of 4-component, see Figure 34c. As a corollary to Theorem 6.18, we have the following result, which was originally stated (in a slightly different form) and proved more directly in [21].

Proposition 7.1 *Two knots γ and γ' in S^3 are C_3 -equivalent if and only if γ and γ' has equal values of the Casson invariant of knots, also known as the second coefficient in the Alexander–Conway polynomial. The group of C_3 -equivalence classes of knots in S^3 with multiplication induced by the connected sum operation is isomorphic to \mathbf{Z} .*

Proof This is clear from the fact that an invariant of type 2 of knots in S^3 is a linear combination of 1 and the second coefficient of the Alexander–Conway polynomial. \square

More generally, a simple C_k -move ($k \geq 1$) is equivalent to band-summing an iterated Bing double [5] of a Hopf link with $k + 1$ components. The result of surgery on a simple strict tree clasper T of degree k for a $(k + 1)$ -component unlink γ such that γ bounds $k + 1$ disjoint disks D_1, \dots, D_{k+1} in such a way that $D_i \cap T$ is an arc for $i = 1, \dots, k + 1$ is an iterated Bing double of a Hopf link. Iterated Bing doubles are successfully used by T Cochran [5] to study the Milnor $\bar{\mu}$ invariants of links. It seems that claspers also work well in studying the Milnor $\bar{\mu}$ invariants. In the next subsection we give a few results concerning the Milnor $\bar{\mu}$ invariants.

7.2 C_k -equivalence and Milnor’s $\bar{\mu}$ invariants

For the definition of the Milnor μ and $\bar{\mu}$ invariants, see [37] or [5].

Theorem 7.2 (1) *For $k, n \geq 1$, the Milnor μ invariants of length $k + 1$ of n -string links in $D^2 \times I$ are invariants of C_{k+1} -equivalence.*

(2) *The Milnor $\bar{\mu}$ invariants of length $k + 1$ of n -component links in S^3 are invariants of C_{k+1} -equivalence. (Recall that each Milnor $\bar{\mu}$ invariant of length*

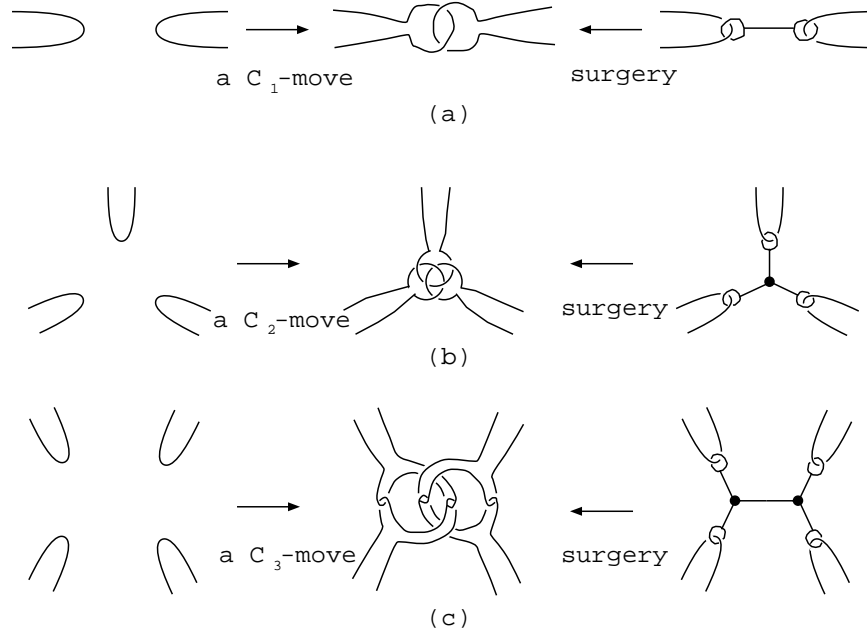

Figure 34

$k + 1$ is only well-defined modulo a certain integer determined by the Milnor $\bar{\mu}$ invariants of length $\leq k$.)

Proof (1) The Milnor μ invariants of length $k + 1$ of string links are invariants of type k [2] [32], and hence invariants of C_{k+1} -equivalence by Corollary 6.8.

(2) If two n -component links γ and γ' are C_{k+1} -equivalent, then they are equivalent to the closure of two mutually C_{k+1} -equivalent n -string links γ_1 and γ'_1 in $D^2 \times [0, 1]$. By (1), γ_1 and γ'_1 have the same values of the Milnor μ invariants of length $\leq k + 1$. Hence γ and γ' have the same values of the Milnor $\bar{\mu}$ invariants of length $\leq k + 1$. \square

Remark 7.3 There is a more direct proof as follows. We can prove that a C_k -move on a link γ preserves the k th nilpotent quotient $(\pi_1 E_\gamma)/(\pi_1 E_\gamma)_{k+1}$ of the fundamental group of the link exterior E_γ of γ in M in a natural way. (See also Section 8.6.) Theorem 7.2 follows directly from this result. We will give the details in a future paper.

By Theorem 6.18, the C_{k+1} -equivalence and the V_k -equivalence are equal for knots in S^3 . For links in S^3 with more than 1 component, we have the following.

Proposition 7.4 For $k \geq 1$, let U_{k+1} denote the $(k + 1)$ -component unlink and let L_{k+1} denote Milnor's link of $(k + 1)$ -components (which is a $(k + 1)$ -component iterated Bing double of a Hopf link), see Figure 35a. Then we have the following.

- (1) U_{k+1} and L_{k+1} are C_k -equivalent but not C_{k+1} -equivalent.
- (2) If $k = 1$, then U_2 and L_2 are V_0 -equivalent but not V_1 -equivalent. If $k \geq 2$, then U_{k+1} and L_{k+1} are V_{2k-1} -equivalent, but not V_{2k} -equivalent.

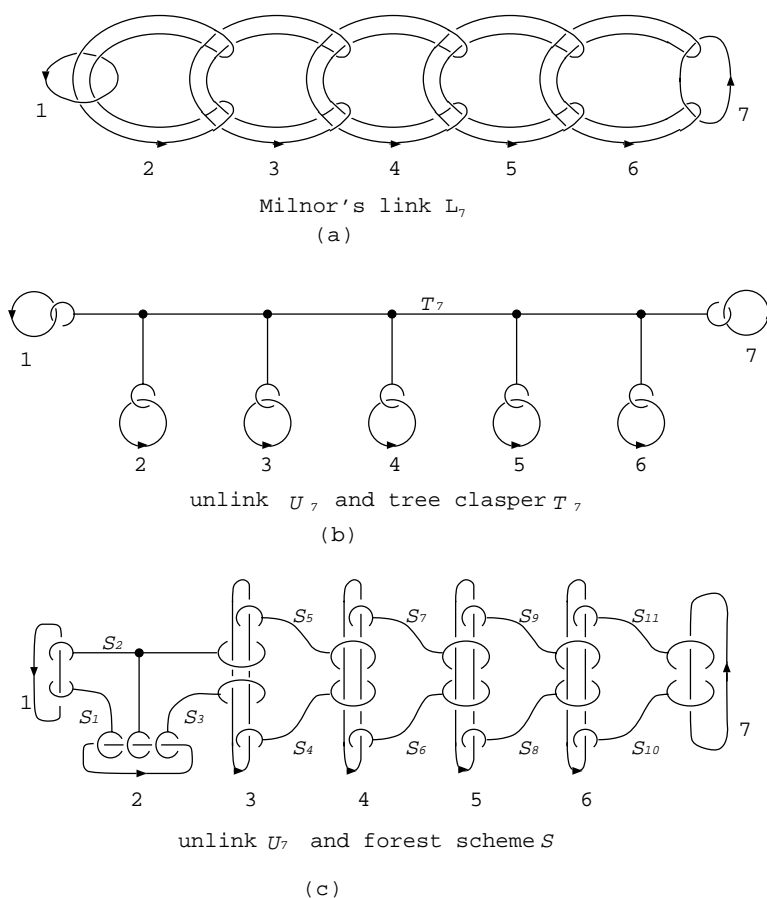

Figure 35: (a) Milnor's link L_7 of 7-components ($k = 6$). (b) Strict tree clasper T_7 for the unlink U_7 . (c) Strict forest scheme $S = S_1 \cup \dots \cup S_{11}$ for U_7 .

Proof We first prove 1. That U_{k+1} and L_{k+1} are C_k -equivalent follows from the fact that surgery on the simple strict tree clasper T_k of degree k for U_{k+1}

as depicted in Figure 35b yields the link L_{k+1} . That U_{k+1} and L_{k+1} are not C_{k+1} -equivalent follows from Theorem 7.2 and the fact that the link L_{k+1} has some non-vanishing Milnor $\bar{\mu}$ invariant of length $k+1$ [36], but U_{k+1} has vanishing Milnor $\bar{\mu}$ invariants.

Now we prove 2. If $k=1$, then L_2 is a Hopf link and the claim clearly holds. Assume that $k \geq 2$. Let $S = \{S_1, \dots, S_{2k-1}\}$ be the forest scheme of degree $2k$ for U_{k+1} as depicted in Figure 35c. Then it is not difficult to prove that $[U_{k+1}; S_1, \dots, S_{2k-1}] = [L_{k+1}] - [U_{k+1}]$. (The proof goes as follows:

$$\begin{aligned} & [U_{k+1}; S_1, \dots, S_{2k-1}] = -[U_{k+1}; S_2, \dots, S_{2k-1}] = [U_{k+1}; S_2, S_4, \dots, S_{2k-1}] \\ & = [U_{k+1}^{S_{2k-1}}; S_2, S_4, \dots, S_{2k-2}] = [U_{k+1}^{S_{2k-2} \cup S_{2k-1}}; S_2, S_4, \dots, S_{2k-3}] \\ & = \dots = [U_{k+1}^{S_4 \cup \dots \cup S_{2k-1}}; S_2] = [L_{k+1}] - [U_{k+1}]. \end{aligned}$$

The details are left to the reader.) Hence L_{k+1} and U_{k+1} are V_{2k-1} -equivalent. That L_{k+1} and U_{k+1} are not V_{2k} -equivalent can be verified, for example, by calculating the linear combination of uni-trivalent graphs of degree $2k$ corresponding to the difference $L_{k+1} - U_{k+1}$ and taking the value of it in, say, the sl_2 -weight system (but not in the Alexander–Conway weight system). \square

Remark 7.5 We can generalize a part of Proposition 7.4 that L_{k+1} is both C_k -equivalent and V_{2k-1} -equivalent to U_k for $k \geq 2$ as follows: If a $(k+1)$ -component link γ in S^3 is Brunnian (ie, every proper sublink of γ is an unlink), then L is both C_k -equivalent and V_{2k-1} -equivalent to the $(k+1)$ -component unlink U_{k+1} . We will prove this result in a future paper.

8 Surveys on some other aspects of the calculus of claspers

In this section we survey some applications of claspers to other field of 3-dimensional topology. We will prove the results below in forthcoming papers.

8.1 Calculus of claspers and commutator calculus in braided category

The reader may have noticed that some of the moves introduced in Proposition 2.7 are similar to the axioms of a Hopf algebra in a braided category. To see this, we think of an edge as a Hopf algebra, a box as a (co)multiplication, a trivial leaf as a (co)unit and a positive half-twist as an antipode. Then move 3

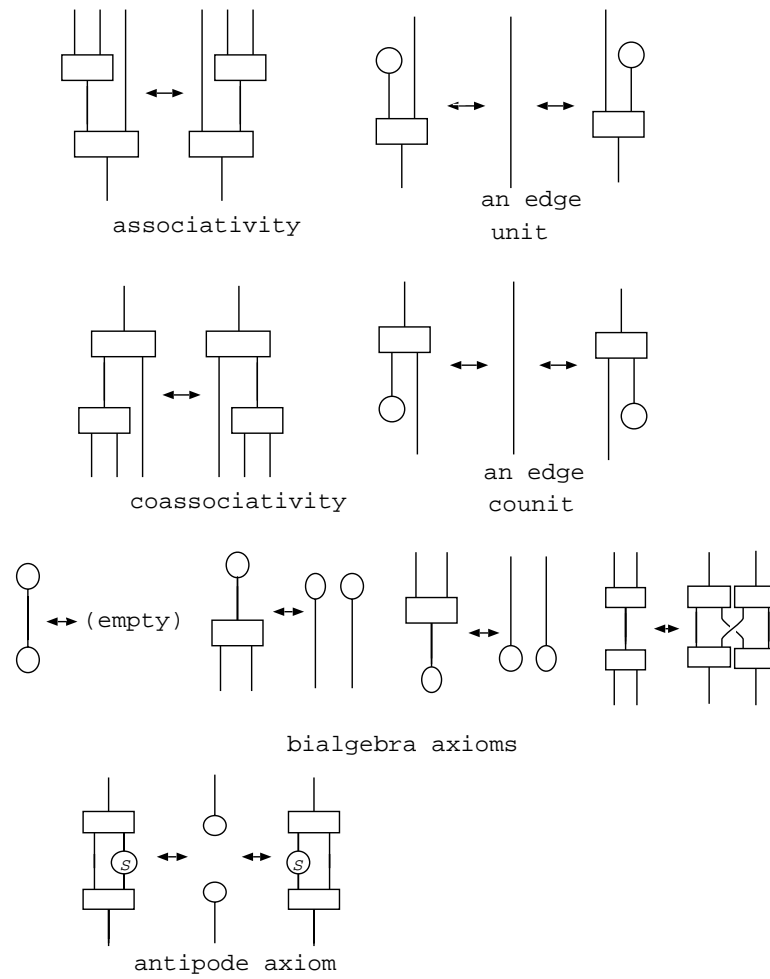

Figure 36: Claspers satisfy the axioms of Hopf algebra in a braided category.

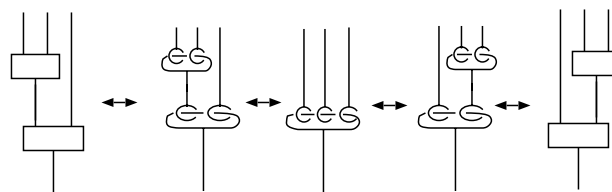

Figure 37

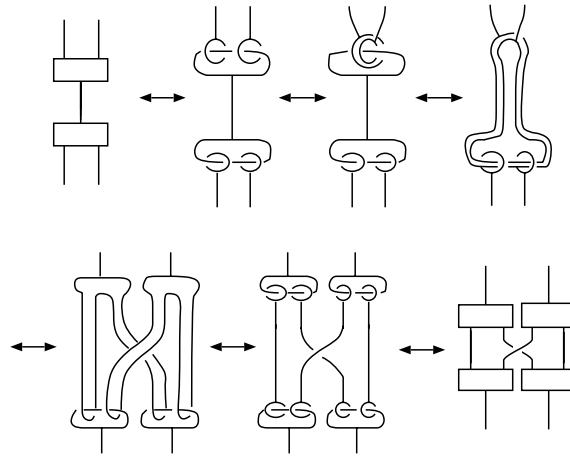

Figure 38

corresponds to the axiom of (co)unit, and move 4 to that of antipode. Other axioms actually hold as illustrated in Figure 36. For the proof of the “associativity” and the fourth of the “bialgebra axioms,” see Figures 37 and 38, respectively. The proofs of the others are easy. This Hopf algebra structure in claspers is closely related to the Hopf algebra structure in categories of cobordisms of surfaces with connected boundary by L Crane and D Yetter [8] and by T Kerler [24].

Let us give a rough definition of the braided category in which claspers live. A *clasper diagram* will mean a picture of a clasper drawn in a square $[0, 1]^2$ with some edges going out of the top and the bottom edges of $[0, 1]^2$, see for example Figure 39. Two clasper diagrams D and D' are said to be equivalent if the numbers of edges of D and D' on the top (resp. bottom) are equal and they represent two surfaces equipped with decompositions in $[0, 1]^3$ that are ambient isotopic to each other relative to boundary of the cube $[0, 1]^3$ (after a suitable reparameterization near the top and the bottom squares). Then the category \mathbf{Cl}_0 of clasper diagrams is defined as follows. The objects of \mathbf{Cl}_0 are nonnegative integers. The morphisms from m to n in \mathbf{Cl}_0 are equivalence classes of clasper diagrams with m edges on the top and n edges on the bottom. The composition is induced by pasting two diagrams vertically. Identity $1_m: m \rightarrow m$ is the equivalence class of the diagram consisting of m vertical edges. The tensor functor $\otimes: \mathbf{Cl}_0 \times \mathbf{Cl}_0 \rightarrow \mathbf{Cl}_0$ is induced by addition of integers and placing two diagrams horizontally. The monoidal unit I is 0. The braiding $\Psi_{m,n}: m \otimes n \rightarrow n \otimes m$ is a positive crossing of two parallel families of

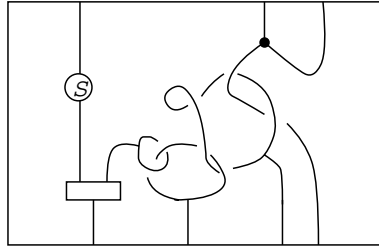

Figure 39: A clasper diagram representing a morphism from 3 to 4 in the category \mathbf{Cl}_0 .



Figure 40

edges.

Let us also give a sketch of the definition of the category **Cob** of cobordisms of oriented connected surfaces with connected boundary. For a precise definition, see [8] or [24]. The objects in **Cob** are nonnegative integers. For each object m in **Cob**, we fix a surface F_m of genus m with one boundary component. We assume that $F_0 = [0, 1]^2$, the surface F_1 is a “square with a handle,” and F_m with $m \geq 2$ are obtained by pasting m copies of F_1 side by side, see Figure 40. For $m \geq 0$, the boundary of F_m is parameterized by $\partial([0, 1]^2)$ in a natural way. A cobordism from F_m to F_n is a 3-manifold with boundary parameterized by the surface $(-F_m) \cup_{\partial([0, 1]^2) \times \{0\}} (\partial([0, 1]^2) \times [0, 1]) \cup_{\partial([0, 1]^2) \times \{1\}} F_n$, where $-F_m$ is F_m with orientation reversed. The morphisms from m to n are the diffeomorphism classes, respecting boundary parameterizations, of cobordisms from F_m to F_n . The composition in **Cob** is induced by “pasting the bottom surface of one cobordism with the top surface of another.” The identity $1_m: m \rightarrow m$ is the direct product $F_m \times [0, 1]$ with the obvious boundary parameterization. The tensor functor is induced by addition of integers and “pasting two cobordisms side by side.” The monoidal unit in **Cob** is 0. (We identify the boundary connected sum of F_m and F_n with F_{m+n} via a certain prescribed diffeomorphism.) The braiding is obtained by “letting two identity cobordisms cross each other positively.”

Then the object 1 in **Cob**, which will be denoted by H , has a Hopf algebra structure [8], [24].

We define a functor $F: \mathbf{Cl}_0 \rightarrow \mathbf{Cob}$ respecting the structure of braided strict

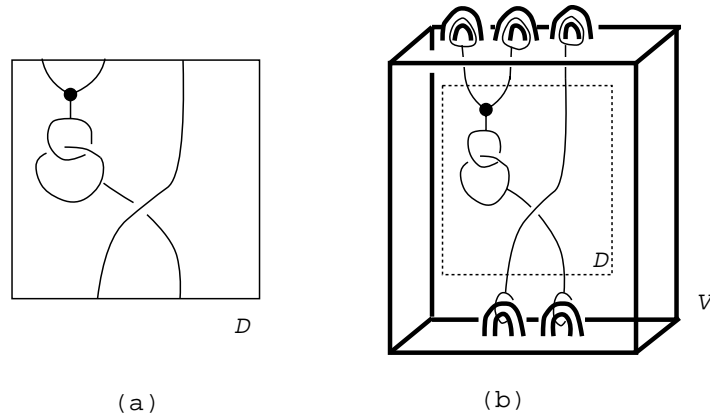

Figure 41: In (a) is a clasper diagram D representing a morphism $[D]$ from 2 to 3 in \mathbf{Cl}_0 . We embed it in a “cube-with-handles-and-holes” V as depicted in (b) together with some extra leaves running through the handles or linking with the holes. Let G_D denote the clasper obtained in this way. The image of $[D]$ by F is represented by the result of surgery from V on G_D .

monoidal categories. On the object level, F maps a nonnegative integer n into n . On the morphism level, F maps a morphism in \mathbf{Cl}_0 into one in \mathbf{Cob} as illustrated in Figure 41. It is not difficult to see that F is a functor and respects the structure of braided strict monoidal category.

The relations among clasper diagrams depicted in Figure 36 implies that there is a Hopf algebra structure on H in \mathbf{Cob} . We can check that this Hopf algebra structure is essentially equivalent to that given in [8] and [24]. Thus clasper diagrams provides a new way to visualize the cobordisms of surfaces. This may be regarded as a variant of a similar visualization of cobordisms using “bridged links” due to Kerler [25].

Let \mathbf{Cl} denote the coimage of the functor F , ie, the category obtained from \mathbf{Cl} by regarding each two morphisms mapped by F into equal morphism to be equal. Of course, \mathbf{Cl} is isomorphic to the image of F . It is easy to check that F is surjective, and hence \mathbf{Cl} is isomorphic to \mathbf{Cob} .

Now we give an interpretation of disk-leaves and leaves as *actions* of the Hopf algebra C on other objects. For this, we extend the notions of clasper diagrams and cobordisms to those involving links and enlarge the categories \mathbf{Cl} and \mathbf{Cob} to \mathbf{Cl}' and \mathbf{Cob}' , respectively. Then we may think of a leaf bounding an embedded disk as a left action of the Hopf algebra on an object, see Figure 42. The “associativity” (b) is equivalent to move 6 and the “unitality” (c) is a

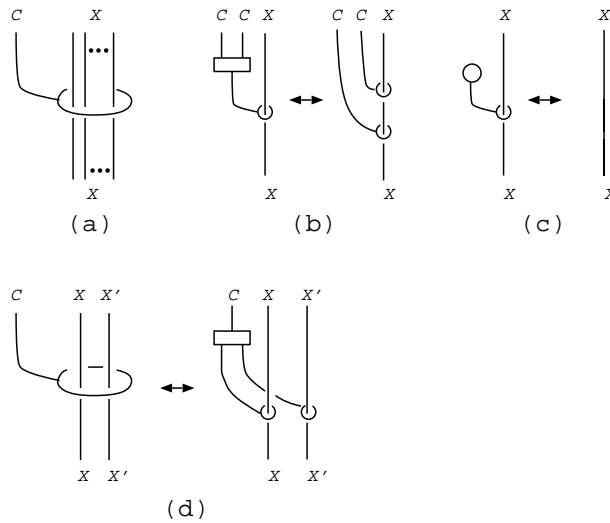

Figure 42: In (b), (c) and (d), the arcs labeled X and X' represents parallel families of edges and strings (but not leaves). (a) Action of C on X . (b) Associativity. (c) Unitality. (d) Action on tensor product.

consequence of move 2. Figure 42d is equivalent to move 8 and shows how the Hopf algebra C acts on the tensor product (ie, parallel) of two objects X and X' . Because of the obvious self duality of the Hopf algebra C in \mathbf{Cl} , we may think of (disk-)leaves also as *coactions*.

Now we give an interpretation of nodes as *(co)commutators*. See Figure 43. We can transform a clasper diagram consisting of a node on the left side to the clasper diagram on the right side. Here the box with many input edges replaces as depicted in Figure 44. We explain how we can think of the right side as a commutator. Recall that one of the most typical examples of Hopf algebras is the *group Hopf algebra* kG of a group G with k a field, where the algebra structure is induced by the group multiplication, the coalgebra structure is given by $\Delta(g) = g \otimes g$ and $\epsilon(g) = 1$ for $g \in G$, and the antipode is given by $S(g) = g^{-1}$ for $g \in G$. So, we try to input two group elements a and b into the two top edges and see what we obtain as the output from the bottom edge. We think of the two upper boxes as comultiplications, which duplicate a and b . We think of the symbols ‘ S ’ as antipodes, which invert the elements a and b in the middle. The braiding permutes a^{-1} and b^{-1} . The lower box acts as a multiplication map and multiplies a , b^{-1} , a^{-1} and b . Hence we obtain a commutator $ab^{-1}a^{-1}b$ as the output. This explains why we think of the left side as a commutator. In the third in Figure 43 we consider the fundamental

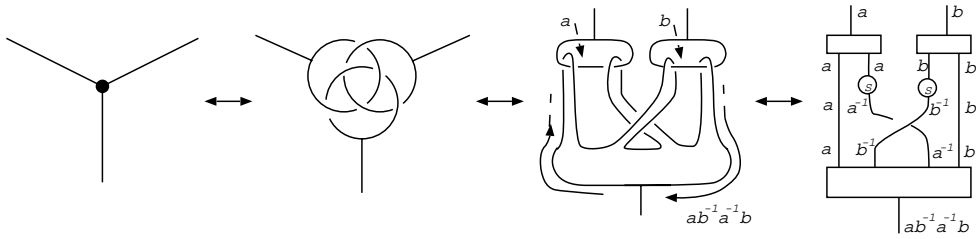

Figure 43

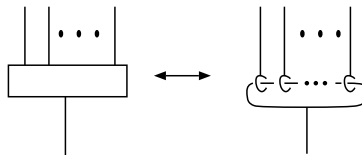

Figure 44

group of the complement of two upper leaves and incident half-edges in $[0, 1]^3$, which is a free group of rank 2 freely generated by the meridians to the two leaves, a and b . Then the element of this free group represented by a boundary component of the lower leaf is again the commutator $ab^{-1}a^{-1}b$.

In this group theoretic analogy, a tree clasper can be thought of as an iterated commutator. We can give group theoretic interpretation to some of the results in the previous sections. For example, Proposition 3.4 is similar to the fact that an iterated commutators of group elements is 1 if at least one on the elements is 1, Proposition 4.4 is similar to the fact that “two iterated commutators of class k and k' commutes each other up to an iterated commutator of class $k+k'$,” and so on. These interpretations greatly help us understand the algebraic nature of calculus of claspers and theory of finite type invariants.

However, this group theoretic analogy does not work very well in some cases. For example, let $\beta^*: C \rightarrow C \otimes C$ be the dual (ie, rotation by π) of the commutator $\beta: C \otimes C \rightarrow C$. We call β^* a *cocommutator*. The cocommutator β^* replaces the dual of the last diagram in Figure 43. It is easy to check that inputting any group element g on the top of this diagram yields $1 \otimes 1$ as output. So, the group theoretic analogy or more generally, such an analogy involving cocommutative Hopf algebras does not work well for cocommutators.

Therefore to understand the algebraic nature of claspers more accurately, we must seek such analogy for more general Hopf algebras in braided categories. This leads us to *commutator calculus of Hopf algebras in braided categories*, or

braided commutator calculus, which may be regarded as a branch of “braided mathematics” proposed by S. Majid. Let us briefly explain commutators and cocommutators appearing in this new commutator calculus here.

Let \mathcal{B} be a braided strict monoidal category and let $H = (H, \mu, u, \Delta, \epsilon, S)$ be a Hopf algebra in \mathcal{B} . Then we define the *commutator* $\beta: H \otimes H \rightarrow H$ via Figure 43. ie, we set

$$\beta = \mu_4(H \otimes \Psi_{H,H} \otimes H)(H \otimes S \otimes S \otimes H)(\Delta \otimes \Delta), \quad (13)$$

where $\mu_4: H^{\otimes 4} \rightarrow H$ is the multiplication with four inputs, and $\Psi_{H,H}$ is the braiding of H and H . Dually we define the *cocommutator* $\gamma: H \rightarrow H \otimes H$ by

$$\gamma = (\mu \otimes \mu)(H \otimes S \otimes S \otimes H)(H \otimes \Psi_{H,H} \otimes H)\Delta_4, \quad (14)$$

where $\Delta_4: H \rightarrow H^{\otimes 4}$ is the comultiplication with four outputs. It seems that commutator calculus based on these (co)commutators works well at least when H is “braided cocommutative with respect to the adjoint action” in S Majid’s sense [33]. This braided cocommutativity is satisfied by the Hopf algebra C in **CI** and hence by H in **Cob**. In this abstract setup, for example, variants of some of the moves in Proposition 2.7 holds, and zip construction works. Commutator calculus in braided category will enable us to handle complicated lemmas on claspers purely algebraically, and moreover help us formalize a large part of calculus of claspers in the language of category theory.

8.2 Graph claspers as topological realization of uni-trivalent graphs

The notion of tree claspers is generalized to that of graph claspers. We may regard graph claspers as “topological realizations” of uni-trivalent graphs that appear in theories of finite type invariant of links and 3–manifolds.

A *graph clasper* G for a link γ in M is a clasper consisting only of leaves, disk-leaves, nodes and edges. G is *admissible* if each component of G has at least one disk-leaf, and is *strict* if, moreover, G has no leaves. G is *simple* if every disk-leaf of G intersects the link with one point. The *degree* of connected strict graph clasper G is half the number of disk-leaves and nodes of G , and the degree of a general strict graph clasper G is the minimum of the degrees of components of G .

A *graph scheme* $S = \{S_1, \dots, S_l\}$ is a scheme consisting of connected graph claspers S_1, \dots, S_l . S is *strict* (resp. *admissible*, *simple*) if every element of S

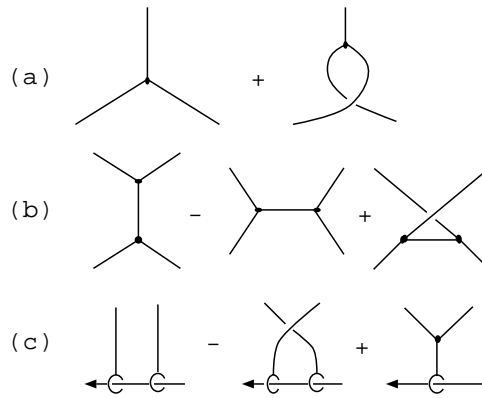

Figure 45

is strict (resp. admissible, simple). The *degree* $\deg S$ of a strict graph scheme S is the sum of the degrees of its elements.

We can generalize a large part of definitions and results in previous sections using graph claspers. For example, we can prove that two links related by a surgery on a strict graph clasper for a link γ of degree $k \geq 1$ are C_k -equivalent. So we may redefine the notion of C_k -equivalence using strict graph claspers. We can also prove that, for a link γ_0 in M , the subgroup $J_k(\gamma_0)$ of $\mathbf{Z}\mathcal{L}_1(\gamma_0)$ equals the subgroup generated by the elements $[\gamma, S]$, where γ is a link in M which is C_1 -equivalent to γ_0 and S is a strict graph scheme for γ_0 of degree k .

We can generalize the definitions and results in Section 4 to simple strict graph claspers. For a link γ_0 in M , let $\tilde{\mathcal{G}}_k^h(\gamma_0)$ denote the free abelian group defined similarly as $\tilde{\mathcal{F}}_k^h(\gamma_0)$ but we use simple strict graph claspers instead of simple forest graph claspers. Let R_k denote the subgroup of $\tilde{\mathcal{G}}_k^h(\gamma_0)$ generated by the elements depicted in Figure 45. They are called antisymmetry relations, IHX relations and STU relations.³ Here we allow only STU relations of a special kind which involves only *connected* graph claspers. We can prove that the natural map $\nu_k: \tilde{\mathcal{G}}_k^h(\gamma_0) \rightarrow \bar{\mathcal{L}}_k(\gamma_0)$ which exists by an analogue of Theorem 4.3 factors through $\tilde{\mathcal{G}}_k^h(\gamma_0)/R_k$.

A *uni-trivalent graph* D on a 1-manifold α is an abstract finite graph D possibly with loop edges and multiple edges such that every vertex of D is of valence 1 or 3, to each trivalent vertex of D is equipped with a cyclic order on the three

³The sign of the last term in the STU relation looks different from the usual one for a technical reason.

incident edges, and to some of the univalent vertices of D are equipped with points on α . Here two distinct vertex must corresponds to distinct points. We call the univalent vertices of D equipped with points in α the univalent vertices on α . A uni-trivalent graph D on a 1-manifold α is *strict* if every univalent vertex is on α and if each connected component of D have at least one univalent vertex. The *degree* of a strict uni-trivalent graph D is half the number of vertices of D .

In the following we restrict our attention to links in S^3 and string links in $D^2 \times [0, 1]$ for simplicity. Let γ_0 be an unlink or a trivial string link. We here refer to links of the same pattern as γ_0 simply as “links.”

For $k \geq 0$, let $\mathcal{A}_k(\gamma_0)$ denote the abelian group generated by strict uni-trivalent graphs of degree k on γ_0 , subject to the framing independence relations and the (usual) STU relations (and hence subject to the antisymmetry and IHX relations). See [1] for the definitions of these relations. We set $\bar{J}_k(\gamma_0) = J_k(\gamma_0)/J_{k+1}(\gamma_0)$. Let $\xi_k: \mathcal{A}_k(\gamma_0) \rightarrow \bar{J}_k(\gamma_0)$ denote a well-known surjective homomorphism which “replaces chords with double points”.⁴ Let $\iota_k: \tilde{\mathcal{G}}_k^h(\gamma_0) \rightarrow \mathcal{A}_k(\gamma_0)$ denote the natural homomorphism which maps a class of a connected simple strict graph clasper G for γ_0 of degree k into the “corresponding strict uni-trivalent graph” of G with an appropriate sign. See Figure 46. Let $\chi_k: \bar{\mathcal{L}}_k(\gamma_0) \rightarrow \bar{J}_k(\gamma_0)$ be the homomorphism defined by $\chi_k([\gamma]_{C_{k+1}}) = [\gamma - \gamma_0]_{J_{k+1}(\gamma_0)}$. Then we can prove that the following diagram commutes (up to sign).⁵

$$\begin{array}{ccc}
 \tilde{\mathcal{G}}_k^h(\gamma_0) & \xrightarrow{\iota_k} & \mathcal{A}_k(\gamma_0) \\
 \nu_k \downarrow & & \downarrow \xi_k \\
 \bar{\mathcal{L}}_k(\gamma_0) & \xrightarrow{\chi_k} & \bar{J}_k(\gamma_0)
 \end{array} \tag{15}$$

From these results, we may think of graph claspers as *topological realizations of strict uni-trivalent graphs*. In other words, any primitive strict uni-trivalent graph, D , of degree k on a γ_0 is “realized” by the knot obtained from the trivial knot by surgery on the simple strict graph clasper G_D such that the “corresponding strict uni-trivalent graph” of G_D is D . Related realization

⁴In a previous version, ξ_k was claimed to be an isomorphism, but it does not seem to be known whether this is an isomorphism. However, $\xi_k \otimes \mathbf{Q}: \mathcal{A}_k(\gamma_0) \otimes \mathbf{Q} \rightarrow \bar{J}_k(\gamma_0) \otimes \mathbf{Q}$ is injective and hence an isomorphism by Kontsevich’s theorem.

⁵In the case of links in S^3 with more than one component, the map χ_k is not injective in general. Conjecture 6.13 for string links in $D^2 \times [0, 1]$ is equivalent to that χ_k is injective for all $k, n \geq 0$. Hence, for string knots and knots in S^3 , χ_k is injective.

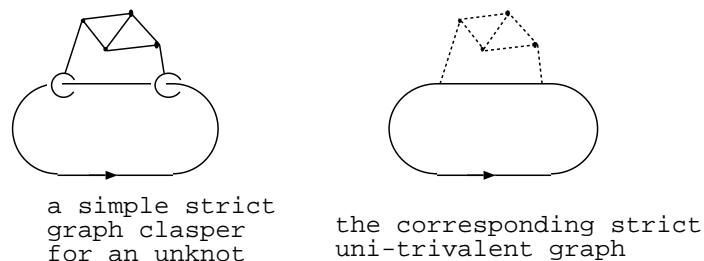

Figure 46

results of uni-trivalent graphs are given by K Y Ng [41] and by N Habegger and G Masbaum [19]. One of the advantages of using graph claspers is that for any connected strict uni-trivalent graph, D , we can immediately find a simple strict graph clasper realizing D .

From the category-theoretical point of view described in 8.1, it is important to note that *the Lie algebraic structures appearing in theories of finite type invariants of links and 3-manifolds originate from the Hopf algebraic structure in the category $\mathbf{CI} \cong \mathbf{Cob}$* (or in a suitably extended category involving links). This is just like that commutator calculus in the associated graded Lie algebra of the lower central series of a group can be explained in terms of commutator calculus in the group.

8.3 New filtrations and equivalence relations on links based on admissible graph claspers

Using admissible graph claspers, we can define a new filtration on links which is much coarser than the Vassiliev–Goussarov filtration and from this filtration we can define a special class of finite type invariants of links in 3-manifolds.

For a connected graph clasper G , the A -degree of G is the number of disk-leaves and nodes of G , and the S -degree of G is $\frac{1}{2}(A\text{-deg } G - l(G))$, where $l(G)$ is the number of leaves of G . For a general graph clasper G , the A -degree (resp. S -degree) of G is the minimum of the A -degrees (resp. S -degrees) of components of G . Observe that the degree of a strict graph clasper equals the S -degree. We define the A -degree (resp. S -degree) of a graph scheme S to be the sum of A -degrees (resp. S -degrees) of elements of S .

A uni-trivalent graph D on a 1-manifold α is said to be H -labeled, where H is an abelian group, if each univalent vertex of D that is not on α is labeled

by an element of H . An H -labeled uni-trivalent graph D on α is *admissible* if every component of D has at least one univalent vertex on α . For such D , the A -degree of D is the sum of the number of the trivalent vertices and the number of the univalent vertices on α , and the S -degree of D is half the difference of A -degree of D and the number of univalent vertices of D not on α .

Let $P = (\alpha, i)$ be a pattern on a 3-manifold M . Let $\mathcal{L}(P)$ denote the set of equivalence classes of links in M of pattern P . For $k \geq 0$, Let $J_k^A(P)$ denote the subgroup of $\mathbf{Z}\mathcal{L}(P)$ generated by all the elements $[\gamma, S]$, where γ is a link in M of pattern P and S is an admissible graph scheme for γ of A -degree k .

For each $k, l \geq 0$ with $0 \leq 2l \leq k$, we define an abelian group $\mathcal{A}_{k,l}^A(P)$ to be generated by admissible $H_1(M; \mathbf{Z})$ -labeled uni-trivalent graphs of A -degree k and of S -degree l , on the 1-manifold α whose univalent vertices are labeled elements of the first homology group $H_1(M; \mathbf{Z})$ and to be subject to the framing independence, antisymmetry, IHX, STU relations and multilinearity of labels.

We set $\bar{J}_k^A(P) = J_k^A(P)/J_{k+1}^A(P)$. For l with $0 \leq 2l \leq k$, let $\bar{J}_{k,l}^A(P)$ denote the subgroup of $\bar{J}_k^A(P)$ generated by the elements $[\gamma, S] \bmod J_{k+1}^A(P)$, where S is an admissible graph schemes for γ of A -degree k and of S -degree $\geq l$.

We can define a natural surjective homomorphism of $\mathcal{A}_{k,l}^A(P)$ onto the graded quotient $\bar{J}_{k,l}^A(P)/\bar{J}_{k,l+1}^A(P)$. By this homomorphism an admissible uni-trivalent graph D is mapped into the element $[\gamma, S_D] \bmod J_{k+1}^A(P)$, where γ is a link of pattern P and S_D is a simple admissible graph scheme whose “corresponding admissible uni-trivalent graph” is D , see Figure 47. Here the homology class of each leaf of S_D equals the label of the corresponding univalent vertex of D .

Since each $\mathcal{A}_{k,l}^A(P)$ is finitely generated, $\bar{J}_{k,l}^A(P)/\bar{J}_{k,l+1}^A(P)$ is finitely generated. Hence $\bar{J}_k^A(P)$ and $\mathbf{Z}\mathcal{L}(P)/J_{k+1}^A(P)$ are finitely generated.

A homomorphism $f: \mathbf{Z}\mathcal{L}(P) \rightarrow X$, where X is an abelian group, is said to be of A -type k if f vanishes on $J_{k+1}^A(P)$. We call the homomorphism $f: \mathbf{Z}\mathcal{L}(P) \rightarrow X$ of finite A -type a *special finite type invariant* since we can prove that an invariant of A -type $2k$ is an invariant of type k . For links in S^3 and string links in $D^2 \times [0, 1]$, we can prove that the notions of A -type $2k$ and that of type k are equivalent. We can prove that, for an integral homology 3-sphere M , there is an isomorphism between the group of invariants of type k for links in M and that of S^3 . This implies that any finite type invariant of links in S^3 canonically extends to a special finite type invariant of links in integral homology 3-spheres. This enables us to extend in a natural way the polynomial

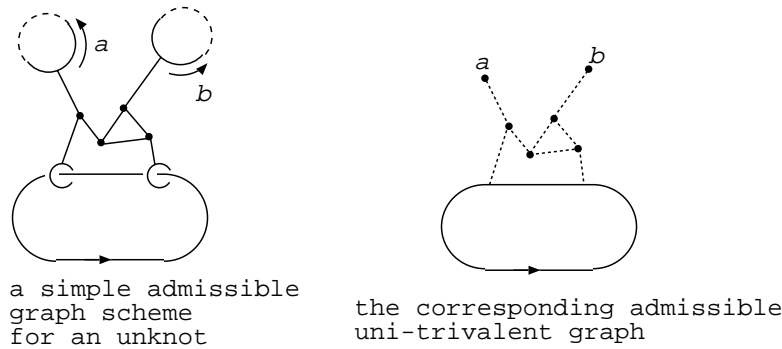

Figure 47: To the simple admissible graph scheme on the left corresponds the admissible uni-trivalent graph on the right that is labeled elements a, b in $H_1(M; \mathbf{Z})$.

invariants such as the Jones, HOMFLY and Kauffman polynomials to links in integral homology spheres.

For $k \geq 1$, an A_k -move on a link is defined to be a surgery on an admissible graph clasper of A -degree k . It is clear that an A_{k+1} -move preserves any invariant of A -type k . The notion of A_k -equivalence is defined in the obvious way. The set of A_k -equivalence classes of n -string links in $\Sigma \times [0, 1]$, where Σ is a connected oriented surface, form a finitely generated nilpotent group (cf. Theorem 5.4). We can define the associated graded Lie algebra, say $\bar{\mathcal{L}}^A(\Sigma, n)$, where the k th homogeneous part is the abelian group of A_{k+1} -equivalence classes of n -string links in $\Sigma \times [0, 1]$ which are A_k -equivalent to the trivial n -string link 1_n . This group is finitely generated. This is a (much more tractable) quotient of the Lie algebra $\bigoplus_{k=1}^{\infty} \hat{\mathcal{L}}_k(\Sigma, n) / \hat{\mathcal{L}}_{k+1}(\Sigma, n)$ defined in Section 5. We can completely determine the structure of the Lie algebra $\bar{\mathcal{L}}^A(\Sigma, n) \otimes \mathbf{Q}$ using admissible $H_1(\Sigma; \mathbf{Z})$ -labeled uni-trivalent graphs, at least when Σ is not closed. In the proof we require the Le-Murakami-Ohtsuki invariant [31].

To some extent the definition of the A -filtration resembles M Goussarov's filtration using "interdependent modifications" [15]. If we use only admissible graph claspers of a special kind such that all the leaves are *null-homotopic* in the 3-manifold, then we obtain a theory equivalent to Goussarov's.

8.4 Clasper surgeries and finite type invariants of 3-manifolds

Theories of clasper surgeries and finite type invariants of links in a fixed 3-manifold developed in previous sections are naturally generalized to that of (3-manifold, link) pairs by allowing graph claspers that are not necessarily

tame. These theories are very closely related to known theories of finite type invariants and surgery equivalence relations of 3-manifolds [42] [31] [11] [7] [6].

After almost finished this paper, the author received a paper of M. Goussarov [16]. It seems that some results in this section overlap that in [16].

8.4.1 A_k -surgery equivalence relations

For simplicity, we consider only compact connected closed 3-manifolds without links, though we can naturally generalize a large part of the following definitions and results to 3-manifolds with boundaries and 3-manifolds with links.

A graph clasper G (for the empty link) in a 3-manifold M is *allowable* if every component of G is not a basic clasper. Note that every component of an allowable G has no disk-leaf and has at least one node. The A -degree of a connected graph clasper G is equal to the number of nodes in G , and the S -degree of G is equal to half the number of nodes minus half the number of leaves. For a connected allowable graph clasper G , we have $A\text{-deg } G \geq 1$ and $S\text{-deg } G \geq -1$. For $k \geq 1$, an A_k -surgery is defined to be a surgery on a connected allowable graph clasper of A -degree k . We define the notion of A_k -surgery equivalence as the equivalence relation on closed 3-manifolds generated by A_k -surgeries and orientation-preserving diffeomorphisms.

It turns out that two 3-manifolds M and M' are A_k -surgery equivalent if and only if there is a connected compact oriented surface F embedded in M (which may be closed or not) and an element α of the k th lower central series subgroup of the Torelli group of F such that the 3-manifold obtained from M by cutting M along F and regluing it using the self-diffeomorphism of F representing α is diffeomorphic to M' . Such modifications of 3-manifolds by elements of the Torelli groups appear in [38] [11] for integral homology 3-spheres.

A result of S V Matveev is restated that two closed 3-manifolds M and M' are A_1 -surgery equivalent if and only if there is an isomorphism of $H_1(M; \mathbf{Z})$ onto $H_1(M'; \mathbf{Z})$ which preserves the torsion linking pairing [35]. We can generalize this result to 3-manifolds with boundaries. An A_2 -surgery preserves the μ -invariant of \mathbf{Z}_2 -homology 3-spheres. The notion of A_k -surgery ($k \geq 1$) works well also for spin 3-manifolds, and an A_2 -surgery preserves the μ -invariant of any closed spin 3-manifolds. An A_3 -surgery preserves the Casson-Walker-Lescop invariant of closed oriented 3-manifolds. Two integral homology 3-spheres M and M' are A_2 - (resp. A_3 -, A_4 -) surgery equivalent if and only if they have equal values of the Rohlin (resp, Casson, Casson) invariant. For more informations on A_k -surgeries, see below, too.

8.4.2 Definition of new filtrations on 3-manifolds

For a closed 3-manifold M , let $\mathcal{M}(M)$ denote the free abelian group generated by the orientation-preserving diffeomorphism classes of 3-manifolds which are A_1 -equivalent to M . In the following we will construct a descending filtration

$$\mathcal{M}(M) = \mathcal{M}_1(M) \supset \mathcal{M}_2(M) \supset \cdots, \quad (16)$$

which we call the A -filtration.

A graph scheme S in M is said to be *allowable* if every element of S is allowable. We define the A -degree (resp. S -degree) of S to be the sum of the A -degrees (resp. S -degrees) of the elements of S . For an allowable graph scheme $S = \{S_1, \dots, S_m\}$ in M , we define an element $[M, S]$ of $\mathcal{M}(M)$ by

$$[M, S] = \sum_{S' \subset S} (-1)^{|S'|} [M^{\cup S'}],$$

where the sum is over all subset of S , $|S'|$ denotes the number of elements in S' and $[M^{\cup S'}]$ denotes the orientation-preserving diffeomorphism class of the result $M^{\cup S'}$ of surgery on the union $\cup S'$ in M . Then, for each $k \geq 0$, we define $\mathcal{M}_k(M)$ as the subgroup of $\mathcal{M}(M)$ generated by the elements $[M, S]$, where S is an allowable graph scheme in M of A -degree k .

We can prove that the quotient group $\mathcal{M}(M)/\mathcal{M}_{k+1}(M)$ is finitely generated by showing that there is a descending filtration

$$\bar{\mathcal{M}}_k(M) = \bar{\mathcal{M}}_{k,-1} \supset \bar{\mathcal{M}}_{k,0} \supset \bar{\mathcal{M}}_{k,1} \supset \cdots \supset \bar{\mathcal{M}}_{k,[k/2]} \supset \{0\} \quad (17)$$

on the group $\bar{\mathcal{M}}_k(M) \stackrel{\text{def}}{=} \mathcal{M}_k(M)/\mathcal{M}_{k+1}(M)$ such that onto each graded quotient $\bar{\mathcal{M}}_{k,l}/\bar{\mathcal{M}}_{k,l+1}$ maps a finitely generated abelian group $\mathcal{A}_{k,l}^{\mathcal{M}}(M)$ generated by $H_1(M; \mathbf{Z})$ -labeled uni-trivalent graphs of A -degree k and of S -degree l .

A homomorphism $f: \mathcal{M}(M) \rightarrow X$, where X is an abelian group, is of A -type k if f vanishes on $\mathcal{M}_{k+1}(M)$. Since $\mathcal{M}(M)/\mathcal{M}_{k+1}(M)$ is a finitely generated abelian group, for a commutative ring with unit, R , the R -valued invariants of A -type k form a finitely generated R -module.

Claspers enables us to prove realization theorems also for finite type invariants of 3-manifolds. For example we can prove that for a 3-manifold M , any integral linear combination of connected $H_1(M, \mathbf{Z})$ -labeled uni-trivalent graphs with k trivalent vertices and with $k - 2l$ univalent vertices can be “realized” by the difference of M and a 3-manifold which is related to M by an A_k -surgery.

It is clear from the definition that if two 3-manifolds M and M' are A_{k+1} -surgery equivalent, then the difference of M and M' lies in $\mathcal{M}_{k+1}(M)$, and

hence they are not distinguished by any invariant of A -type k . The converse does not hold in general. As with the case of links, we may say that the notion of A_{k+1} -surgery equivalence is more fundamental than the equivalence relations determined by the A -filtration. However, two integral homology 3-spheres are A_{k+1} -equivalent if and only if they are not distinguished by any invariant of A -type k . The proof of this is very similar to that of Theorem 6.18. Theorem 6.17 can be also translated into integral homology spheres: We can define the *universal additive A -type k invariant* of integral homology 3-spheres.

8.4.3 Comparison with other filtrations

Here we compare the A -filtration (16) and other filtrations in literature. In [11], S Garoufalidis and J Levine defined a filtration on integral homology spheres using framed links bounding surfaces, which they call “blinks.” This filtration can be directly generalized to general 3-manifolds and we can prove that this filtration equals the A -filtration. For homology spheres, by a result of Garoufalidis and Levine, this equality implies that the A -filtration is, after re-indexing and tensoring $\mathbf{Z}[\frac{1}{2}]$, equal to T Ohtsuki’s original filtration using algebraically split framed links [42]. Garoufalidis and Levine also proved that there are no rational invariant of odd degree. We can generalize this to that for *closed* 3-manifolds any rational invariant of A -type $2k - 1$ is of A -type $2k$. (This cannot be generalized for 3-manifolds with boundaries.)

Now we compare the A -filtration with the Ohtsuki’s filtration on integral homology 3-spheres and also with the generalization to more general 3-manifolds by T Cochran and P Melvin [7]. Here we call these filtrations the Ohtsuki–Cochran–Melvin filtrations. It turns out that the $3k$ th subgroup of the Ohtsuki–Cochran–Melvin filtration is contained in $\mathcal{M}_k(M)$, hence an invariant of A -type k is an invariant of Ohtsuki–Cochran–Melvin type $3k$. A $\mathbf{Z}[\frac{1}{2}]$ -module valued invariant of A -type $2k$ is an invariant of Ohtsuki–Cochran–Melvin type $3k$. Hence the A -filtration is coarser than the Ohtsuki–Cochran–Melvin filtration. In some respects, the A -filtration is easier to handle than the Ohtsuki–Cochran–Melvin filtration. Using graph schemes, we can also re-define the Ohtsuki–Cochran–Melvin filtration. We can define this filtration like the A -filtration, but, instead of the notion of A -degree, we use that of E -degree, which is defined to be the number of edges either connecting two nodes or connecting a node with an unknotted leaf with -1 framing not linking with other leaves nor edges. This definition enables us to study the Ohtsuki–Cochran–Melvin filtration using claspers.

Now we compare the notion of A_k -surgery equivalence with the notion of k -surgery equivalence introduced by T. D. Cochran, A. Gerges and K. Orr [6]. Recall that two 3-manifolds M and M' are k -surgery equivalent to each other if they are related by a finite sequence of Dehn surgeries on ± 1 -framed knots whose homotopy classes lie in the k th lower central series subgroups of the fundamental groups of the 3-manifolds. It is easy to see that 2-surgery equivalence implies A_1 -surgery equivalence. For each $k \geq 2$, A_{2k-2} -surgery equivalence implies k -surgery equivalence. However, it is clear that every integral homology sphere is k -surgery equivalent to S^3 for all $k \geq 2$, while the A_{2k} -equivalence becomes strictly finer for integral homology spheres as k increases.

8.4.4 Examples of invariants of finite A -type

There are many nontrivial invariants of finite A -type. First of all, we can prove that, for $k \geq 0$, the Le–Murakami–Ohtsuki invariant Ω_k of closed 3-manifolds [31] is of A -type $2k$ (and hence of Ohtsuki–Cochran–Melvin type $3k$, since any rational invariants of Ohtsuki–Cochran–Melvin type $3k$ are of A -type $2k$).

We can generalize a result of T Q T Le [30] to rational homology 3-spheres: Ω_k is the universal rational-valued invariant of rational homology 3-spheres of A -type $2k$.

S Garoufalidis and N Habegger [10] proved that the coefficient C_{2k} of z^{2k} in the Conway polynomial of a closed 3-manifold with first homology group isomorphic to \mathbf{Z} factors through Ω_k . Hence C_{2k} is an invariant of A -type $2k$. Recall that C_{2k} is an invariant of Ohtsuki–Cochran–Melvin type $2k$ [7].

N Habegger proved that the Le–Murakami–Ohtsuki invariant vanishes for closed 3-manifolds with first Betti number ≥ 4 [17]. It turns out that for 3-manifolds that are A_1 -equivalent to a fixed closed 3-manifold with first Betti number $3k \geq 0$, the \mathbf{Q} -vector space of rational invariants of A -type $2k$ of such manifolds is isomorphic to the $GL(3k; \mathbf{Z})$ -invariant subspace of $\text{Sym}^{2k}(\wedge^3 V)$, where V is \mathbf{Q}^{3k} with the canonical action of $GL(3k; \mathbf{Z})$. This invariant subspace is non-zero, and hence there are nontrivial rational invariants (and hence integral invariants) of A -type $2k$ of closed 3-manifolds of first Betti number $3k$ for every $k \geq 0$. These invariants are homogeneous polynomial of order $2k$ of triple cup products $\alpha \cup \beta \cup \gamma \in H^3(M; \mathbf{Z}) \cong \mathbf{Z}$ of $\alpha, \beta, \gamma \in H^1(M; \mathbf{Z})$ evaluated at the fundamental class of M . Hence they are of Ohtsuki–Cochran–Melvin type 0. For closed 3-manifolds with first Betti number b , there are no non-constant rational invariant of A -type $k < 2b/3$.

Theory of finite A -type invariants suggests that there should be a refinement of the Le–Murakami–Ohtsuki invariant which does not vanish for 3-manifolds with high first Betti numbers and which is universal among the rational valued finite A -type invariants.

8.5 Groups of homology cobordisms of surfaces

In Section 5, we proved that for a connected oriented surface Σ , the set of C_k -equivalence classes of n -string links in $\Sigma \times [0, 1]$ forms a group. This group plays a fundamental role in studying the C_k -equivalence relations and finite type invariants of links. For A_k -equivalence relations and finite type invariants of 3-manifolds, the *group of A_k -equivalence classes of homology cobordisms of a surface* plays a similar role. This group will serve as a new tool in studying the mapping class groups of surfaces.

Let Σ be a connected compact oriented surface of genus $g \geq 0$ possibly with some boundary components. We set $H = H_1(M; \mathbf{Z})$.

A *homology cobordism* $C = (C, \phi)$ of Σ is a pair of a 3-manifold C and an orientation-preserving diffeomorphism $\phi: \partial(\Sigma \times [0, 1]) \xrightarrow{\cong} \partial C$ such that both the two inclusions $\phi|_{\Sigma \times [0, 1]}: \Sigma \times \{i\} \hookrightarrow C$ for $i = 0, 1$ induce isomorphisms on the first homology groups with integral coefficients. Two homology cobordisms (C, ϕ) and (C', ϕ') are said to be *equivalent* if there is an orientation-preserving diffeomorphism $\Phi: C \xrightarrow{\cong} C'$ such that $\phi' = (\Phi|_{\partial C})\phi$. For two homology cobordisms $C_1 = (C_1, \phi_1)$ and $C_2 = (C_2, \phi_2)$, the *composition* $C_1 C_2 = (C_1, \phi_1)(C_2, \phi_2)$ is defined by “pasting the bottom of C_1 and the top of C_2 .” The set of equivalence classes of homology cobordisms of Σ , $\mathcal{C}(\Sigma)$ forms a monoid with multiplication induced from the composition operation defined above, and with unit the equivalence class of the *trivial* homology cobordism $1_\Sigma = (\Sigma \times [0, 1], \text{id}_{\partial(\Sigma \times [0, 1])})$.

A homology cobordism C is *homologically trivial* if, for the two embeddings

$$i_\epsilon: \Sigma \xrightarrow{\cong} \Sigma \times \{\epsilon\} \hookrightarrow C, \quad (\epsilon = 0, 1),$$

the composition $(i_1)_*^{-1}(i_0)_*: H \rightarrow H$ of the induced isomorphisms is the identity. Let $\mathcal{C}_1(\Sigma)$ denote the submonoid of $\mathcal{C}(\Sigma)$ consisting of the equivalence classes of homologically trivial cobordisms of Σ .

For each $k \geq 1$, we define the notion of A_k -equivalence of homology cobordisms in the obvious way. For $k \geq 1$, let $\mathcal{C}_k(\Sigma)$ denote the submonoid of $\mathcal{C}(\Sigma)$ consisting of the equivalence classes of homology cobordisms that are A_k -equivalent

to the trivial cobordism 1_Σ . This defines a descending filtration on $\mathcal{C}_1(\Sigma)$,

$$\mathcal{C}_1(\Sigma) \supset \mathcal{C}_2(\Sigma) \supset \cdots . \tag{18}$$

We can prove that the two definitions of $\mathcal{C}_1(\Sigma)$ are equivalent, ie, a homology cobordism of Σ is homologically trivial if and only if it is A_1 -equivalent to 1_Σ .

Now we consider the descending filtration of quotient monoids by the A_{k+1} -equivalence relation

$$\mathcal{C}(\Sigma)/A_{k+1} \supset \mathcal{C}_1(\Sigma)/A_{k+1} \supset \cdots \supset \mathcal{C}_k(\Sigma)/A_{k+1}. \tag{19}$$

These monoids are *finitely generated groups*, and moreover $\mathcal{C}_i(\Sigma)/A_{k+1}$ is nilpotent for $i = 1, \dots, k$. Especially, $\bar{\mathcal{C}}_k(\Sigma) \stackrel{\text{def}}{=} \mathcal{C}_k(\Sigma)/A_{k+1}$ is an abelian group. We define, when Σ is not closed and $k \geq 2$, a finitely generated abelian group $\mathcal{A}_k(\Sigma)$ generated by allowable H -labeled uni-trivalent graphs of A -degree k on the empty 1-manifold equipped with a total order on the set of univalent vertices. Here an H -labeled uni-trivalent graph D is *allowable* if each components of D has at least one trivalent vertex. These uni-trivalent graphs are subject to the antisymmetry relations, the IHX relations, the ‘‘STU-like relations’’ and the multilinearity of labels. Here the ‘‘STU-like relation’’ is depicted in Figure 48. When Σ is closed and $k \geq 2$, we define $A_k(\Sigma)$ to be the quotient of $A_k(\Sigma \setminus \text{int } D^2)$ by the relation depicted in Figure 49. When Σ is not closed and $k = 1$, we set $\mathcal{A}_1(\Sigma) = \wedge^3 H \oplus \wedge^2 H_2 \oplus H_2 \oplus \mathbf{Z}_2$, where we set $H_2 = H_1(\Sigma; \mathbf{Z}_2) \cong H \otimes \mathbf{Z}_2$. When $k = 1$ and Σ is closed, we set $\mathcal{A}_1(\Sigma) = \wedge^3 H / (\omega \wedge H) \oplus \wedge^2 H_2 / (\omega_2) \oplus H_2 \oplus \mathbf{Z}_2$, where $\omega = \sum_{i=1}^g x_i \wedge y_i \in \wedge^2 H$ for a symplectic basis $x_1, y_1, \dots, x_g, y_g \in H$, and ω_2 is the mod 2 reduction of ω .

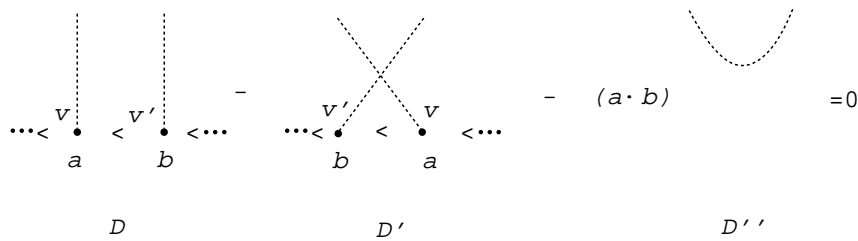

Figure 48: Let D be a uni-trivalent graph and let $v < v'$ be two consecutive univalent vertices in D labeled $a, b \in H_1(\Sigma; \mathbf{Z})$. Let D' be the uni-trivalent graph obtained from D by exchanging the order of v and v' . Let D'' denote the uni-trivalent graph obtained from D by connecting two vertices v and v' . Then the ‘‘STU-like relation’’ states that $D - D' - (a \cdot b)D'' = 0$, where $a \cdot b \in \mathbf{Z}$ denote the intersection number of a and b . In this figure the univalent vertices are placed according to the total order.

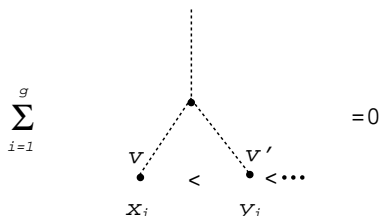

Figure 49: This relation states that $\sum_{i=1}^g D_{x_i, y_i} = 0$, where the elements $x_1, y_1, \dots, x_g, y_g$ form a symplectic basis of $H_1(\Sigma; \mathbf{Z})$, and D_{x_i, y_i} is a uni-trivalent graph with the smallest two univalent vertices v and v' adjacent to the same trivalent vertex such that v and v' are labeled x_i and y_i , respectively. This relation does not depend on the choice of the symplectic basis.

There is a natural surjective homomorphism of $A_k(\Sigma)$ onto $\bar{\mathcal{C}}_k(\Sigma)$. We conjecture that this is an isomorphism. This conjecture holds when $k = 1$. We can also prove this conjecture over \mathbf{Q} for $k \geq 1$ with Σ non-closed, using the Le–Murakami–Ohtsuki invariant.

We can naturally define a graded Lie algebra structure on the graded abelian group $\bar{\mathcal{C}}(\Sigma) \stackrel{\text{def}}{=} \bigoplus_{k=1}^{\infty} \bar{\mathcal{C}}_k(\Sigma)$. When Σ is not closed, we can give a presentation of the Lie algebra $\bar{\mathcal{C}}(\Sigma) \otimes \mathbf{Q}$ in terms of uni-trivalent graphs. (Again, the proof requires the Le–Murakami–Ohtsuki invariant.)

Groups and Lie algebras of homology cobordisms of surfaces will serve as *new tools in studying the mapping class groups of surfaces*. This is because we can think of a self-diffeomorphism of a surface Σ as a homology cobordism of Σ via the mapping cylinder construction. The filtration (18) restricts to a filtration on the Torelli group of Σ , which is coarser than or equal to the lower central series of the Torelli group⁶ and is finer than the filtration given by considering the action of the Torelli group on the fundamental group $\pi_1 \Sigma$ [23][39]. We can naturally extend the Johnson homomorphisms to homologically trivial cobordisms and describe it in terms of tree claspers and tree-like uni-trivalent graphs. It is extremely important to clarify the relationships between the presentation of the Lie algebra $\bar{\mathcal{C}}(\Sigma) \otimes \mathbf{Q}$ in terms of uni-trivalent graphs and R Hain’s presentation of the associated graded of the lower central series of the Torelli group [22].

⁶At low genus we can prove that they are different, but at high genus it is open if they are different or not. We conjecture that they are stably equal.

8.6 Claspers and gropes

Some authors use *gropes* to study links and 3-manifolds [6] [29]. We explain here some relationships between claspers and gropes *embedded* in 3-manifolds.

For the definitions of *gropes* and *capped gropes*, see [9]. We define a (*capped*) *k-grope* X for a link γ in M to be a (*capped*) grope X of class k embedded in M intersecting γ only by some transverse double points in the caps of X . (In the non-capped case, X and γ are disjoint.)

Two links γ and γ' in M are said to be related by a (*capped*) *k-groping* if there is a (*capped*) *k-grope* X for γ and a band B connecting a component of γ and the bottom b of X in such a way that $B \cap X = \partial B \cap b$ and $B \cap \gamma = \partial B \cap \gamma$, and if the band sum of γ and b along the band B is equivalent to γ' .

We can prove that two links in M are related by a sequence of capped *k-gropings* (resp. *k-gropings*) if and only if they are C_k -equivalent (resp. A_k -equivalent). As corollaries to this, we can prove that an A_k -move on a link in M preserves the homotopy classes of the components of a link up to the k th lower central series subgroup of $\pi_1 M$, and that the k th nilpotent quotient (ie, the quotient by the $k+1$ st lower central series subgroup) of the fundamental group of the link exterior is an invariant of A_k -equivalence classes of links (and hence of C_k -equivalence classes). From this we can also prove that an A_k -surgery on a 3-manifold preserves the k th nilpotent quotient of the fundamental group of 3-manifolds.

Recall that for a knot γ in a 3-manifold M , the homotopy class of γ lies in the k th lower central series subgroup of $\pi_1 M$ if and only if there is map f of a grope X of class k into M such that the bottom of X is mapped diffeomorphically onto γ . This condition is much weaker than that γ bounds an embedded *k-grope* in M . In some sense, embedded gropes, and hence tree and graph claspers, may be thought of as a kind of “geometric commutator” in a 3-manifold. Gropes thus provide us another way of thinking of calculus of claspers as a commutator calculus of a new kind.

References

- [1] **D Bar-Natan**, *On the Vassiliev knot invariants*, *Topology*, 34 (1995) 423–472
- [2] **D Bar-Natan**, *Vassiliev homotopy string link invariants*, *J. Knot Theory Ramifications*, 4 (1995) 13–32
- [3] **J S Birman**, *New points of view in knot theory*, *Bull. Amer. Math. Soc.* 28 (1993) 253–287
- [4] **J S Birman**, **X S Lin**, *Knot polynomials and Vassiliev’s invariants*, *Invent. Math.* 111 (1993) 225–270
- [5] **T D Cochran**, *Derivatives of links: Milnor’s concordance invariants and Massey’s products*, *Mem. Amer. Math. Soc.* 84 (1990) no. 427
- [6] **T D Cochran**, **A Gerges**, **K Orr**, *Surgery equivalence relations on three-manifolds*, preprint
- [7] **T D Cochran**, **P M Melvin**, *Finite type invariants of 3-manifolds*, preprint
- [8] **L Crane**, **D Yetter**, *On algebraic structures implicit in Topological Quantum Field Theories*, preprint
- [9] **M H Freedman**, **P Teichner**, *4-Manifold topology II: Dwyer’s filtration and surgery kernels*, *Invent. Math.* 122 (1995) 531–557
- [10] **S Garoufalidis**, **N Habegger**, *The Alexander polynomial and finite type 3-manifold invariants*, preprint
- [11] **S Garoufalidis**, **J Levine**, *Finite type 3-manifold invariants, the mapping class group and blinks*, *J. Diff. Geom.* 47 (1997) 257–320
- [12] **S Garoufalidis**, **T Ohtsuki**, *On finite type 3-manifold invariants III: manifold weight systems*, *Topology*, 37 (1998) 227–243
- [13] **M N Goussarov**, *A new form of the Conway–Jones polynomial of oriented links*, from: “Topology of manifolds and varieties”, *Adv. Soviet Math.* 18, Amer. Math. Soc. Providence, RI (1994) 167–172
- [14] **M N Goussarov**, *On n -equivalence of knots and invariants of finite degree*, from: “Topology of manifolds and varieties”, *Adv. Soviet Math.* 18, Amer. Math. Soc. Providence, RI (1994) 173–192
- [15] **M N Goussarov**, *Interdependent modifications of links and invariants of finite degree*, *Topology*, 37 (1998) 595–602
- [16] **M N Goussarov**, *New theory of invariants of finite degree for 3-manifolds*, (in Russian) preprint
- [17] **N Habegger**, *A computation of the universal quantum 3-manifold invariant for manifolds of rank greater than 2*, preprint
- [18] **N Habegger**, **X S Lin**, *The classification of links up to link-homotopy*, *J. Amer. Math. Soc.* 3 (1990) 389–419
- [19] **N Habegger**, **G Masbaum**, *The Kontsevich integral and Milnor’s invariants*, preprint

- [20] **K Habiro**, *Claspers and the Vassiliev skein modules*, PhD thesis, University of Tokyo (1997)
- [21] **K Habiro**, *Clasp-pass moves on knots*, unpublished
- [22] **R Hain**, *Infinitesimal presentations of the Torelli groups*, J. Amer. Math. Soc. 10 (1997) 597–651
- [23] **D Johnson**, *An abelian quotient of the mapping class group*, Math. Ann. 249 (1980) 225–242
- [24] **T Kerler**, *Genealogy of nonperturbative quantum-invariants of 3-manifolds: The surgical family*, from: “Geometry and physics”, Lecture Notes in Pure and Appl. Math. 184, Dekker, New York (1997) 503–547
- [25] **T Kerler**, *Bridged links and tangle presentations of cobordism categories*, preprint
- [26] **R C Kirby**, *A calculus of framed links in S^3* , Invent. Math. 65 (1978) 35–56
- [27] **T Kohno**, *Vassiliev invariants and de-Rham complex on the space of knots*, from: “Symplectic geometry and quantization”, Contemp. Math. 179, Amer. Math. Soc. Providence, RI (1994) 123–138
- [28] **M Kontsevich**, *Vassiliev’s knot invariants*, from: “IM Gelfand seminar”, Adv. Soviet Math. 16 Part 2, Amer. Math. Soc. Providence, RI (1993) 137–150
- [29] **V S Krushkal**, *Additivity properties of Milnor’s $\bar{\mu}$ -invariants*, J. Knot Theory Ramifications, 7 (1998) 625–637
- [30] **T Q T Le**, *An invariant of integral homology 3-spheres which is universal for all finite type invariants*, from: “Solitons, geometry and topology: on the cross-road”, Amer. Math. Soc. Transl. Ser. 2, 179 (1997) 75–100,
- [31] **T Q T Le, J Murakami, T Ohtsuki**, *On a universal quantum invariant of 3-manifolds*, Topology, 37 (1998) 539–574
- [32] **X S Lin**, *Power series expansions and invariants of links*, from “Geometric topology”, AMS/IP Stud. Adv. Math. 2.1, Amer. Math. Soc. Providence, RI (1997) 184–202
- [33] **S Majid**, *Algebras and Hopf algebras in braided categories*, from: “Advances in Hopf algebras”, Lecture Notes in Pure and Appl. Math. 158, Dekker, New York (1994) 55–105
- [34] **S Majid**, *Foundations of quantum group theory*, Cambridge University Press, Cambridge (1995)
- [35] **S V Matveev**, *Generalized surgeries of three-dimensional manifolds and representations of homology spheres*, (in Russian) Mat. Zametki 42 (1987) 268–278, 345
- [36] **J Milnor**, *Link groups*, Ann. of Math. 59 (1954) 177–195
- [37] **J Milnor**, *Isotopy of links Algebraic geometry and topology*, from: “A symposium in honor of S Lefschetz”, Princeton University Press, Princeton, NJ (1957) 280–306

- [38] **S Morita**, *Casson's invariant for homology 3-spheres and characteristic classes of surface bundles I*, *Topology*, 28 (1989) 305–323
- [39] **S Morita**, *Abelian quotients of subgroups of the mapping class group of surfaces*, *Duke Math. J.* 70 (1993) 699–726
- [40] **H Murakami, Y Nakanishi**, *On a certain move generating link-homology*, *Math. Ann.* 284 (1989) 75–89
- [41] **K Y Ng**, *Groups of ribbon knots*, *Topology*, 37 (1998) 441–458
- [42] **T Ohtsuki**, *Finite type invariants of integral homology 3-spheres*, *J. Knot Theory Ramifications*, 5 (1996) 101–115
- [43] **T Stanford**, *Finite type invariants of knots, links, and graphs*, *Topology*, 35 (1996) 1027–1050
- [44] **T Stanford**, *Braid commutators and Vassiliev invariants*, *Pacific Jour. of Math.* 174 (1996) 269–276
- [45] **T Stanford**, *Vassiliev invariants and knots modulo pure braid subgroups*, preprint
- [46] **V A Vassiliev**, *Cohomology of knot spaces*, from: “Theory of Singularities and its Applications”, *Adv. Soviet Math.*, Amer. Math. Soc. Providence, RI (1990) 23–69