

Geometry & Topology Monographs
 Volume 2: Proceedings of the Kirbyfest
 Pages 215{232

Right integrals and invariants of three-manifolds

Louis H Kauffman

Abstract This paper gives a summary of our approach to invariants of three manifolds via right integrals on finite dimensional Hopf algebras and their relation to the Kirby calculus.

It gives the author great pleasure to dedicate this paper to Rob Kirby on his sixtieth birthday.

AMS Classification 57N10; 57M50

Keywords Three-manifold, knot, link, Hopf algebra, antipode, ribbon element, trace, right integral

1 Introduction

This paper is a capsule summary of our approach to invariants of three manifolds via right integrals on finite dimensional Hopf algebras. The aim of this paper is to quickly show the reader how natural it is to consider right integrals in this context. The defining property of a right integral is a categorical algebra translation of the handle-sliding move in the Kirby calculus.

We show in [5] that invariants defined in terms of right integrals, as considered in this paper, are distinct from the invariants of Reshetikhin and Turaev [24]. We show that the Hennings invariant (defined via these integrals) is non-trivial for the quantum group $U_q(SL_2)^\theta$ when q is a fourth root of unity. The Reshetikhin Turaev invariant is trivial at this quantum group and root of unity. The Hennings invariant distinguishes all the Lens spaces $L(n; 1)$ from one another at this root of unity. This proves that there is non-trivial topological information in the non-semisimplicity of $U_q(SL_2)^\theta$. This non-triviality result has also been obtained by Ohtsuki [17].

The reader interested in comparing the approach of this paper with other ways to look at quantum link invariants will enjoy looking at the references [3], [9], [11], [15], [16], [18], [19], [23], [24], [27]. In particular, the method we use to write link invariants directly in relation to a Hopf algebra is an analog of the

construction in [15] and it is a generalization of the formalism of [23] and [24]. The papers [9], [16], [12], [13] consider categorical frameworks that also use right integrals on Hopf algebras.

The paper is organized as follows. Section 2 recalls the Hopf algebra background. Section 3 recalls the category associated with a Hopf algebra. Section 4 weaves in the Tangle category and constructs the functor from the Tangle category to the Hopf algebra category. Section 5 describes the invariants of three manifolds.

Acknowledgement I thank the National Science Foundation for support of this research under NSF Grant DMS-9205277 and the NSA for partial support under grant number MSPF-96G-179.

2 Algebra

Recall that a Hopf algebra A [25] is a bialgebra over a commutative ring k that has an associative multiplication and a coassociative comultiplication and is equipped with a counit, a unit and an antipode. The ring k is usually taken to be a field. A is an algebra with multiplication $m: A \otimes A \rightarrow A$. The associative law for m is expressed by the equation $m(m \circ 1_A) = m(1_A \circ m)$ where 1_A denotes the identity map on A .

The coproduct $\Delta: A \rightarrow A \otimes A$ is an algebra homomorphism and is coassociative in the sense that $(\Delta \circ 1_A) \circ \Delta = (1_A \circ \Delta) \circ \Delta$:

The unit is a mapping from k to A taking 1 in k to 1 in A , and thereby defining an action of k on A : It will be convenient to just identify the units in k and in A , and to ignore the name of the map that gives the unit.

The counit is an algebra mapping from A to k denoted by $\epsilon: A \rightarrow k$: The following formulas for the counit dualize the structure inherent in the unit: $(\epsilon \circ 1_A) \circ \Delta = 1_A = (1_A \circ \Delta) \circ \epsilon$:

It is convenient to write formally

$$(\Delta x) = \sum_{x_1, x_2 \in A} x_1 \otimes x_2$$

to indicate the decomposition of the coproduct of x into a sum of first and second factors in the two-fold tensor product of A with itself. We shall often drop the summation sign and write

$$(\Delta x) = x_1 \otimes x_2$$

The antipode is a mapping $s: A \rightarrow A$ satisfying the equations $m(1_A \otimes s)(x) = (x)1$; and $m(s \otimes 1_A)(x) = (x)1$ where 1 on the right hand side of these equations denotes the unit of k as identified with the unit of A : It is a consequence of this definition that $s(xy) = s(y)s(x)$ for all x and y in A .

A quasitriangular Hopf algebra A [1] is a Hopf algebra with an element $\Sigma \in A \otimes A$ satisfying the following equations:

1) $\Sigma = \Sigma^{-1}$ where Σ^{-1} is the composition of Σ with the map on $A \otimes A$ that switches the two factors.

2)

$$\begin{aligned} \Sigma_{13} \Sigma_{12} &= (1_A \otimes \Sigma) ; \\ \Sigma_{13} \Sigma_{23} &= (\Sigma \otimes 1_A) ; \end{aligned}$$

Remark The symbol Σ_{ij} denotes the placement of the first and second tensor factors of Σ in the i and j places in a triple tensor product. For example, if $\Sigma = \sum e^i \otimes e^j$ then

$$\Sigma_{13} = \sum e^i \otimes 1_A \otimes e^j.$$

These conditions imply that Σ has an inverse, and that

$$\Sigma^{-1} = (1_A \otimes s^{-1}) \Sigma = (s \otimes 1_A) \Sigma ;$$

It follows easily from the axioms of the quasitriangular Hopf algebra that Σ satisfies the Yang-Baxter equation

$$\Sigma_{12} \Sigma_{13} \Sigma_{23} = \Sigma_{23} \Sigma_{13} \Sigma_{12}.$$

A less obvious fact about quasitriangular Hopf algebras is that there exists an element u such that u is invertible and $s^2(x) = uxu^{-1}$ for all x in A : In fact, we may take $u = \sum s(e^i)e^i$ where $\Sigma = \sum e^i \otimes e^i$. This result is due to Drinfeld [1].

An element G in a Hopf algebra is said to be *grouplike* if $\Delta(G) = G \otimes G$ and $\epsilon(G) = 1$ (from which it follows that G is invertible and $s(G) = G^{-1}$). A quasitriangular Hopf algebra is said to be a *ribbon Hopf algebra* [22], [4] if there exists a grouplike element G such that (with u as in the previous paragraph) $v = G^{-1}u$ is in the center of A and $s(u) = G^{-1}uG^{-1}$. We call G a *special grouplike element* of A .

Since $v = G^{-1}u$ is central, $vx = xv$ for all x in A . Therefore $G^{-1}ux = xG^{-1}u$: We know that $s^2(x) = uxu^{-1}$: Thus $s^2(x) = GxG^{-1}$ for all x in A : Similarly, $s(v) = s(G^{-1}u) = s(u)s(G^{-1}) = G^{-1}uG^{-1}G = G^{-1}u = v$: Thus the square of the antipode is represented as conjugation by the special grouplike element in a ribbon Hopf algebra, and the central element $v = G^{-1}u$ is invariant under the antipode.

3 Categories and Functors

We will recall in capsule form the method for obtaining invariants of knots, links and 3-manifolds that we used in [5], [6] and [7]. This method produces a functor

$$F: \text{Tang} \rightarrow \text{Cat}(A)$$

where *Tang* is the category of unoriented tangles taken up to regular isotopy, and *Cat*(*A*) is a natural category associated with a quasi-triangular Hopf algebra. We first recall the structure of *Cat*(*A*), then show how right integrals on the Hopf algebra lead to invariants of three manifolds.

In this recollection, we start by describing the association of a category with an algebra *A*, not necessarily a Hopf algebra, and then add structure to the category corresponding to properties of a Hopf algebra. By the end of the discussion, the category will have been built.

At the outset *A* is an algebra with a commutative ground ring *R*, so that *A* is a module over *R*: *Cat*(*A*) is an (associative tensor) category whose objects are generated under tensor product by two objects *k* and *V* such that *k* ⊗ *k* = *k* and *k* ⊗ *V* = *V* ⊗ *k* = *V*; and whose morphisms are generated using composition and tensor product, from basic morphisms that will be defined in this section. The object *V* is strictly abstract. The object *k* will be identified with the ground ring *R* as described below. Functors on this category will often associate to *V* a representation space of the algebra *A*:

To each element *a* of the algebra *A* there will be a generating morphism (still denoted by *a*)

$$a: V \rightarrow V:$$

Multiplication in the algebra corresponds to composition of the corresponding morphisms. The identity morphism 1_V corresponds to the identity element 1 in the algebra *A*. In the same way, elements of the tensor powers A^n of the algebra correspond to morphisms with domain and range V^n :

Morphisms in *Cat*(*A*) corresponding to elements of the algebra are denoted by vertical upward pointing arrows (with the domain below the range). We shall customarily denote the presence of the algebra element *a* by a "bead" (a node) on the arrow with the label *a*: An unlabelled arrow without a bead corresponds to the identity morphism 1_V : See Figure 1.

The algebra *A* has a base ring *R* (usually a field). The object *k* in the category is identified with the base ring *R*. If $i: k \rightarrow A$ denotes the unit in the algebra

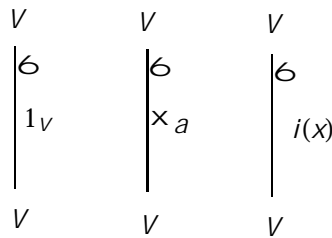

Figure 1: Labelled Arrow

(ie, $i(x) = x1$ where x is in k and 1 is the unit in the algebra) then elements of $i(k)$ form a special set of morphisms in the category since

$$i(x)a \ b = a \ i(x)b$$

for any x in k and a and b in A . Accordingly, we shall denote a morphism in $Cat(A)$ that corresponds to an element w in $i(k)$ by an arrow *without a bead* but labelled with w . In this way we can move the label w freely and when it leaves a given arrow, that arrow (if otherwise unlabelled) reverts to an identity arrow as it should. See Figure 1.

We are free to utilize the internal structure of the base ring k when that is appropriate. It is a curious feature of this category that one of its objects is also the holder of an important subcategory (the morphisms generated by $i(k)$). In other respects the base object k can be regarded in a purely external categorical way.

Every Hopf algebra has an antipode $s: A \rightarrow A$ with the defining property that

$$m(s \circ 1_A)(\) = m(s \circ 1_A)(\) = i(\)$$

where $m: A \otimes A \rightarrow A$ is the multiplication in the algebra, $\epsilon: A \rightarrow k$ is the counit, and $\Delta: A \rightarrow A \otimes A$ is the coproduct. A key property of the antipode is that it is an antimorphism of the algebra to itself. It reverses the order of multiplication so that

$$s(ab) = s(b)s(a)$$

for all a and b in A :

The structure of the antipode is reflected in the category $Cat(A)$ by new morphisms that we now describe as

$$Cup: k \rightarrow V \otimes V$$

and

$$Cap: V \otimes V \rightarrow k:$$

The key property of these morphisms is their behaviour with respect to the antipode:

$$(a \ 1_V) \ Cup = (1_V \ s(a)) \ Cup;$$

$$Cap \ (1_V \ a) = Cap \ (s(a) \ 1_V):$$

These morphisms and all the remaining morphisms that we construct in this category are represented by (immersed) curves in the plane. See Figure 2 for the diagrammatic depiction of *Cup*, *Cap* and these "bead sliding" properties. It is convenient to think of these identities as permissions to slide the beads past maxima or minima in the diagrams for the morphisms. Upon sliding across a maximum in a counterclockwise direction, a bead has the antipode applied to it.

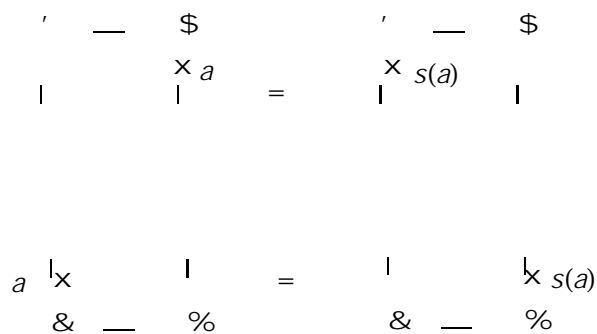

Figure 2: Bead Sliding for Cups and Caps

The properties of *Cup* and *Cap* are augmented with the *topological* identities

$$(Cup \ 1_V)(1_V \ Cap) = 1_V;$$

$$(1_V \ Cup)(Cap \ 1_V) = 1_V:$$

See Figure 3. These identities assert that *Cup* and *Cap* behave just as topological maxima and minima: when composed without any intervening morphisms they cancel to the identity.

It follows from the antipodal and topological behaviour of *Cup* and *Cap* that the morphism corresponding to *s(a)* is represented by composing on the top and the bottom of *a* with a *Cup* and a *Cap*, as shown in Figure 4. A proof by bead sliding is shown in that Figure.

Formally, we have the result:

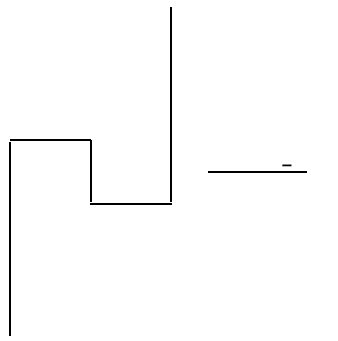

Figure 3: Cup Cap Cancellation

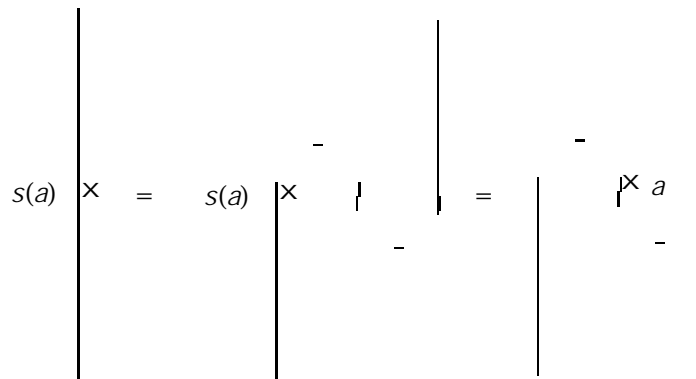

Figure 4: Bead Sliding for the Antipode

Lemma *Let a be an element of A viewed as a morphism from V to V . Then $s(a) = (1_V \text{ Cup})(1_V \ a \ 1_V)(\text{Cap} \ 1_V)$.*

Proof $(1_V \ \text{Cup})(1_V \ a \ 1_V)(\text{Cap} \ 1_V)$
 $= (1_V \ \text{Cup})(1_V \ 1_V \ s(a))(\text{Cap} \ 1_V)$
 $= (1_V \ \text{Cup})(\text{Cap} \ 1_V)s(a)$
 $= 1_V s(a) = s(a):$ □

In fact, the cup and cap morphisms provide an interpretation of $s(f)$ for any morphism $f: V \rightarrow V$ in the category by the replacement of a by f in the diagram in Figure 4, and in the formula of this lemma. Thus

$$s(f) = (1_V \ \text{Cup})(1_V \ f \ 1_V)(\text{Cap} \ 1_V):$$

One last type of morphism completes that catalog for $Cat(A)$: This morphism is a formal permutation

$$P: V \otimes V \rightarrow V \otimes V$$

with the property

$$P(a \otimes b) = (b \otimes a) \circ P$$

We represent P by a pair of crossed arrows as shown in Figure 5.

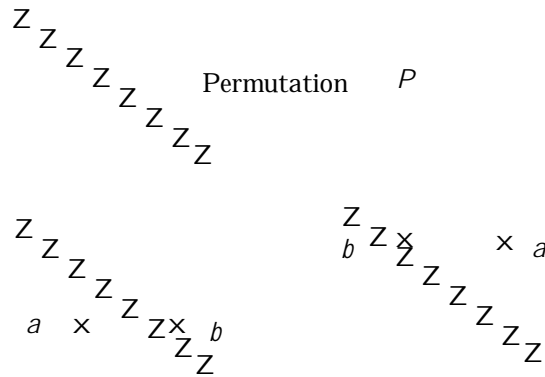

Figure 5: The Permutation

It is assumed that P satisfies the usual axioms for permutation plus a compatibility condition with respect to the *Cup* and the *Cap* as shown in Figure 6.

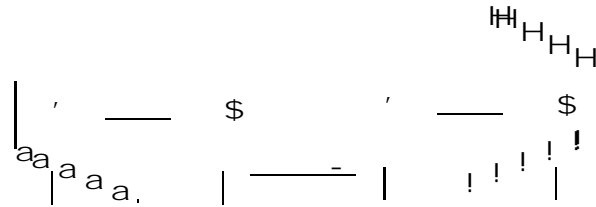

Figure 6: Permutation Switchback

The Hopf algebra A is endowed with a coproduct

$$\Delta: A \rightarrow A \otimes A$$

This map is indicated algebraically via the formula

$$\Delta(a) = a_1 \otimes a_2$$

where an implicit summation is sometimes indicated without the presence of the summation symbol. In diagrams the line with a bead labelled a on it is replaced by a two parallel lines (for the tensor product) with the left line's bead labelled a_1 and the right line's bead labelled a_2 : See Figure 7.

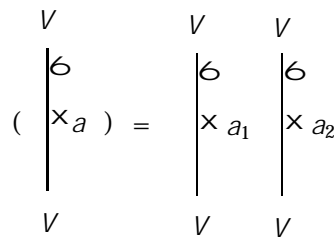

Figure 7: Diagramming the coproduct

Clearly Δ must simply double all diagrammatic lines to be defined on the structural morphisms in $Cat(A)$. This is illustrated in Figure 8.

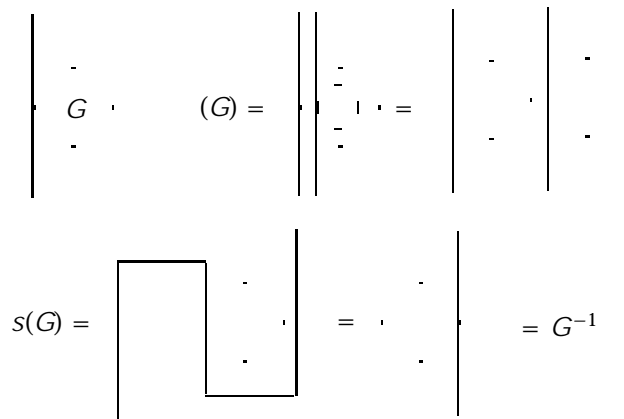

Figure 8: Delta on Diagrams

3.1 Curls

Before going to the tangle category it is useful to delineate special morphisms in $Cat(A)$ that we call "curls".

A *curl* is a morphism of the form $G = (1_V \text{ Cup})P(1_V \text{ Cap})$ or $G^{-1} = (\text{Cup } 1_V)P(\text{Cap } 1_V)$. The second curl is denoted by G^{-1} because the

equations $GG^{-1} = 1_V = G^{-1}G$ hold via a regular homotopy of the corresponding plane curves. (The regular homotopy is implicitly shown in Figure 9.) These equations are the categorical analog of the so-called "Whitney trick". The Whitney Graustein Theorem [26] tells us that any morphism from V to V with no elements of A in its factorization is equivalent to an integer power of G .

The element G is a formal grouplike element in the sense that $(G) = G \ G$ as illustrated in Figure 8.

In terms of the morphism G we can represent the square of the antipode in $Cat(A)$ by the formula

$$s^2(a) = GaG^{-1}$$

where this formula denotes a composition of morphisms in $Cat(A)$: In many cases the element G can be identified with a specific grouplike element in the Hopf algebra A . The category takes the lead here in expressing a preference for such a formula. See Figure 9.

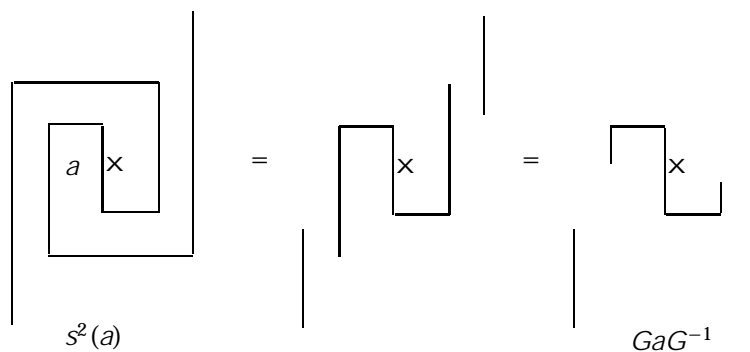

Figure 9: The Square of the Antipode

It is now easy to see the following:

Lemma Every morphism x in $Cat(A)$ with source and target both V can be written in the form aG^n where $a \in A$ and n is an integer.

Proof This result is accomplished by sliding all the algebra on the immersed curve that represents the morphism to the bottom of the curve. The element a is the algebraic element so concentrated at the top of the curve. The curve itself is regularly homotopic (fixing the ends at top and bottom) to G^n for a unique integer n (the Whitney degree of that curve). Since regular homotopy

is produced by the topological axioms of the category, this shows that $x = aG^n$ as desired. \square

Remark Using the method of this proof, we define $w(x) = a$ and $d(x) = n$ so that $x = w(x)G^{d(x)}$:

4 The Tangle Category

For the detailed definition of *Tang* we refer the reader to [7]. The objects will again be formally generated by two (formal) symbols k and V as for $Cat(A)$: The morphisms of *Tang* are generated by *Cup*, *Cap*, the identity line (and its tensor products) and the *right and left crossings*, maps of $V \otimes V$ to itself. The crossings are denoted R and L as shown in Figure 10. R denotes a crossing of two arcs so that the overcrossing line goes upward from right to left. L denotes a crossing of two arcs so that the overcrossing line goes upward from left to right.

All diagrams of morphisms in *Tang* are drawn in the plane with no intersections of lines other than the formalized crossings. The crossings are intended to be interpreted in sense of the knot theorist. That is, one can *interpret* such a diagram as representing an embedding in three-dimensional space of a collection of curves. The crossing indicates that one curve passes over another from the point of view of a planar projection.

Note that the permutation P of the category $Cat(A)$ is absent from *Tang*: The crossings can be regarded as generalizations of the permutation. We will shortly use this idea in making a functor F from *Tang* to $Cat(A)$:

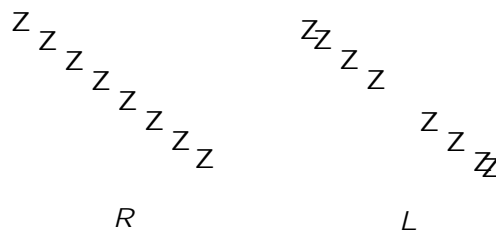

Figure 10: Right and Left Crossings

Every morphism in the tangle category is a composition of the elementary morphisms *Cup*, *Cap*, R and L : The objects in *Tang* are identical to the objects in $Cat(A)$:

While the objects in the tangle category are very simple, the morphisms are quite complex. Each morphism in the tangle category consists in a link diagram with free ends which is transverse with respect to a given direction in the plane. (This special direction will be called the *vertical* direction.) The transversality of the diagram to this vertical direction means that any given line perpendicular to the vertical direction intersects the diagram either tangentially at a maximum or a minimum, at non-zero angle for any other strand. We shall further assume that any given perpendicular intersects the diagram at most at one crossing. With these stipulations the free ends of the diagram occur at either its top or its bottom (top and bottom taken with respect to the designated vertical direction). We shall assume that all the top ends occur along the same perpendicular, and that all the bottom ends occur along another perpendicular to the vertical. To each of these two rows of diagram ends is assigned a tensor product of copies of V , one for each end. In the tangle category, the diagram is a morphism from the lower tensor product to the upper tensor product. If the top of a diagram has no free ends, then its range is k . If the bottom of a diagram has no free ends, then its domain is k . A diagram is said to be *closed* if it has no free ends. Thus a closed diagram is a morphism from k to k . If A and B are morphisms in the tangle category with $Range(B) = Domain(A)$, then the composition of A and B is denoted AB .

In discussing $Tang$ we shall continue to use the topological terminology *tangle* for a morphism in the category. An $n - m$ tangle is a tangle with n inputs and m outputs. Thus a $1 - 1$ tangle is any map from V to V in $Tang$, and a $0 - 0$ tangle is any knot or link arranged with respect to the vertical to give a morphism from k to k . If T is an $n - m$ tangle in $Tang$ we define $\sigma(T)$ to be the $2n - 2m$ tangle obtained by replacing every strand of T by two parallel copies of that strand.

4.1 The Functor $F: Tang \rightarrow Cat(A)$

Let A be a quasi-triangular Hopf algebra. Let $\sigma \in A \otimes A$ denote the Yang-Baxter element for A and write σ symbolically in the form $\sigma = \sum e^i \otimes e^j$. We wish to define a functor from $Tang$ to $Cat(A)$. It suffices to define F on the generating morphisms R, L, Cup and Cap . We define

$$\begin{aligned} F(Cup) &= Cup; \\ F(Cap) &= Cap; \\ F(R) &= P = P \left(\sum e^i \otimes e^j \right) = \sum P(e^i \otimes e^j); \end{aligned}$$

$$F(L) = \sum (s(e) \ e^\ell) P = \sum (e \ s^{-1}(e^\ell)) P;$$

Diagrammatically, it is convenient to picture $F(R)$ as a flat crossing with beads *above* the crossing labeled e and e^ℓ from left to right, with the summation indicated by the double appearance of the letter e . Similarly, $F(L)$ is depicted as a crossing with beads *below* the crossing and labeled $s(e)$ and e^ℓ . See Figure 11.

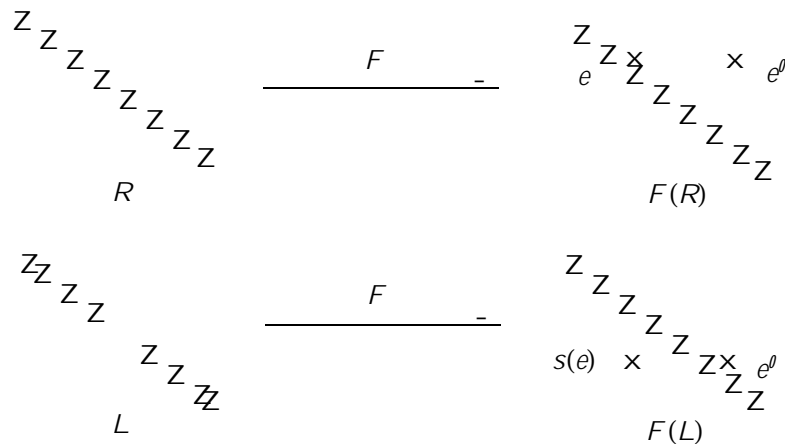

Figure 11: The Functor F on Right and Left Crossings

Proof that this functor is well-defined is found in [5] and [7].

Knowing that F is a functor on the tangle category, means that we have implicitly defined many invariants of knots and links, since regularly isotopic tangles will have equivalent images under F . We can immediately state the following Theorem for $1 - 1$ tangles, giving invariants with values in the Hopf algebra A .

Theorem *Let T be a single-stranded, $1 - 1$ tangle. That is, T is a "knot on a string". Then $F(T) = w[T]G^{d(T)}$ is a regular isotopy invariant of T . Here $w[T] = w(F(T))$ is the element of A defined in the last section by concentrating all the algebra in $F(T)$ in the lower part of the tangle, and $d(T)$ is the Whitney degree of the plane curve underlying T . In fact $w[T] \in A$ is itself a regular isotopy invariant of T , as is $d(T)$.*

For the proof see [7].

Example In Figure 12 we illustrate how a topological curl gives rise under the functor F to the special central element $v = G^{-1}u$ of a ribbon Hopf algebra. This element is of particular use in defining the invariants described in the next section.

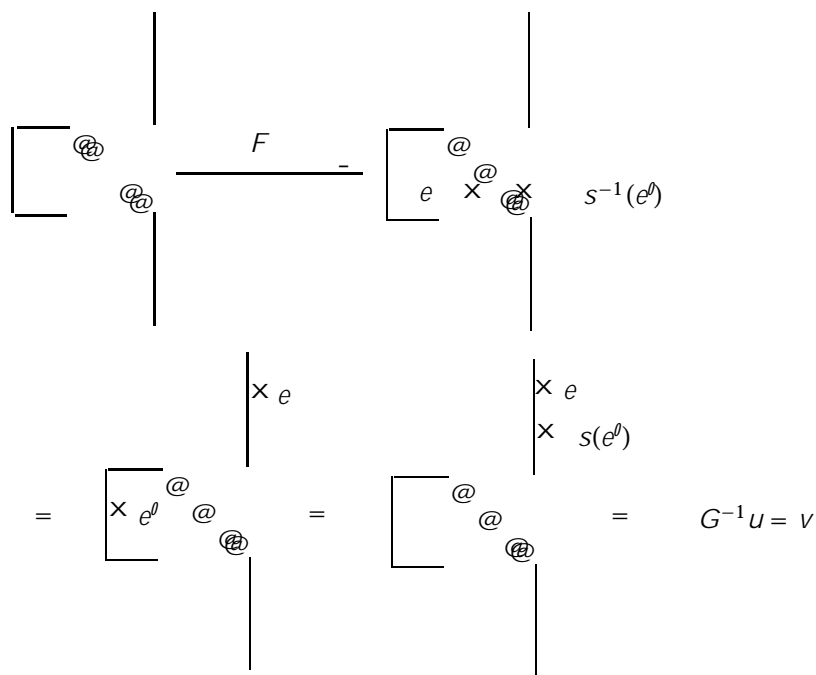

Figure 12: The Ribbon Element v

5 Invariants of 3-manifolds

The structure we have built so far can be used to construct invariants of 3-manifolds presented in terms of surgery on framed links. We sketch here our technique that simplifies an approach to 3-manifold invariants of Mark Hennings [2].

Recall that an element u of the dual algebra A is said to be a *right integral* if $(x)1 = m(1)(x)$ for all x in A : For a unimodular [14],[18] finite dimensional ribbon Hopf algebra A there is a right integral u satisfying the following properties for all x and y in A :

- 0) u is unique up to scalar multiplication when k is a field.
- 1) $(xy)u = (s^2(y)x)u$:
- 2) $(gx)u = (s(x)u)$ where $g = G^2$, G the special grouplike element for the ribbon element $v = G^{-1}u$:

Given the existence of this integral u , define a functional $tr: A \rightarrow k$ by the

formula

$$tr(x) = \text{tr}(Gx):$$

(It follows from the fact that $s^2(G) = G$ that $\text{tr}(Gx) = \text{tr}(xG)$.)

It is then easy to prove the following theorem [5].

Trace Theorem *The function tr defined as above satisfies*

$$tr(xy) = tr(yx) \text{ for all } x, y \text{ in } A$$

and

$$tr(s(x)) = tr(x) \text{ for all } x, y \text{ in } A:$$

The upshot of this theorem is that for a unimodular finite dimensional Hopf algebra there is a natural trace defined via the existent right integral. Remarkably, this trace is just designed to behave well with respect to handle sliding [6], [5]. Handle sliding is the basic transformation on framed links that leaves the corresponding 3-manifold obtained by framed surgery unchanged. See [10]. This means that a suitably normalized version of this trace on framed links gives an invariant of 3-manifolds. For a link K , we let $TR(K)$ denote the functional on links, as described in the previous section, defined via tr as above.

To see how the condition on handle sliding and the property of being a right integral are related in our category, we refer the reader to Figure 13 where the basic form of handle sliding is illustrated and its algebraic counterpart is shown. The algebraic counterpart arises when we concentrate all the algebra in a given link component in one place on the diagram. The component is then replaced by a circle and formally its evaluation is $O_R(x)$ for a suitable x in the Hopf algebra where $O_R(x)$ denotes the evaluation of the morphism corresponding to a circle labelled with x as in the Figure. As the diagram shows, if we let $\text{tr}(x) = O_R(x)$, then invariance under handle sliding is implicated by tr being a right integral on the Hopf algebra.

A proper normalization of $TR(K)$ gives an invariant of the 3-manifold obtained by framed surgery on K : More precisely (assuming that $\text{tr}(v)$ and $\text{tr}(v^{-1})$ are non-zero), let

$$INV(K) = (\text{tr}(v) \text{tr}(v^{-1}))^{-c(K)-2} (\text{tr}(v) = \text{tr}(v^{-1}))^{-\text{sgn}(K)-2} TR(K)$$

where $c(K)$ denotes the number of components of K , and $\text{sgn}(K)$ denotes the signature of the matrix of linking numbers of the components of K (with framing numbers on the diagonal). Then $INV(K)$ is an invariant of the 3-manifold obtained by doing framed surgery on K in the blackboard framing. This is our reconstruction of Hennings invariant [2] in an intrinsically unoriented context.

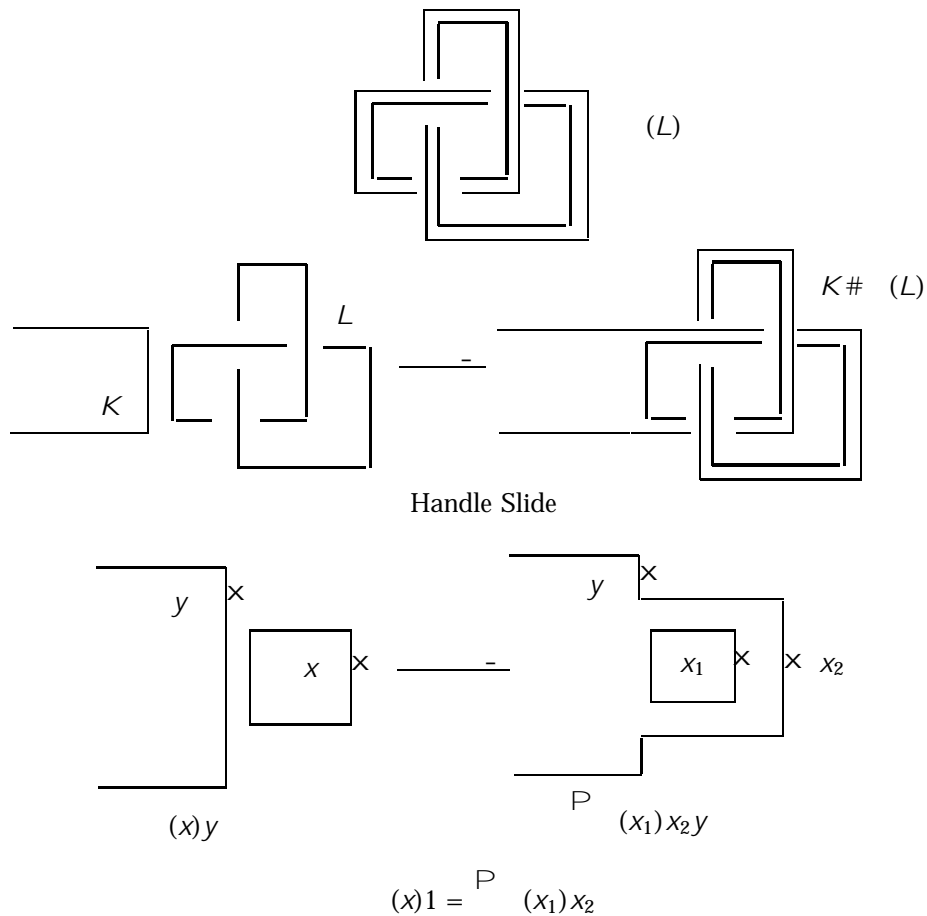

Figure 13: Handle Sliding and Right Integral

References

- [1] **V G Drinfeld**, *Quantum groups*, Proceedings of the International Congress of Mathematicians, Berkeley, California, USA (1987) 798{820
- [2] **MA Hennings**, *Invariants of links and 3-manifolds obtained from Hopf algebras*, preprint (1989)
- [3] **LH Kauffman**, *Knots and Physics*, World Sci. Pub. (1991 and 1994)
- [4] **LH Kauffman, DE Radford**, *A necessary and sufficient condition for a finite-dimensional Drinfel'd double to be a ribbon Hopf algebra*, Journal of Algebra, 159 (1993) 98{114

- [5] **L H Kau man, D E Radford**, *Invariants of 3-manifolds derived from finite dimensional Hopf algebras*, Journal of Knot Theory and Its Ramifications, 4 (1995) 131{162
- [6] **L H Kau man**, *Hopf algebras and invariants of 3-manifolds*, Journal of Pure and Applied Algebra, 100 (1995) 73{92
- [7] **L H Kau man, D Radford, S Sawin**, *Centrality and the KRH Invariant*, Journal of Knot Theory and Its Ramifications, 7 (1998) 571{624
- [8] **L H Kau man, D E Radford**, *Quantum algebras, quantum coalgebras, invariants of 1 – 1 tangles and knots*, (to appear)
- [9] **T Kerler**, *Mapping Class Group Actions on Quantum Doubles*, (to appear in Commun. Math. Phys.)
- [10] **R Kirby**, *A calculus for framed links in S^3* , Invent. Math. 45 (1978) 35{56
- [11] **R Kirby, P Melvin**, *The 3-manifold invariants of Witten and Reshetikhin{ Turaev for $sl(2; C)$* , Invent. Math. 105 (1991) 473{545
- [12] **G Kuperberg**, *Involutory Hopf algebras and 3-manifold invariants*, Int. J. of Math. 2 (1991) 41{66
- [13] **G Kuperberg**, *Non-involutory Hopf algebras and 3-manifold invariants*, Duke J. Math. 4 (1996) 83{129
- [14] **R G Larson, M E Sweedler**, *An associative orthogonal bilinear form for Hopf algebras*, Amer J. Math. 91 (1969) 75{94
- [15] **R J Lawrence**, *A universal link invariant*, from: "The Interface of Mathematics and Particle Physics", (D G Quillen, G B Segal and S T Tsou, editors), Oxford University Press (1990) 151{156
- [16] **V Lyubashenko**, *Invariants of 3-Manifolds and Projective Representations of Mapping Class Groups at Roots of Unity*, (to appear in Commun. Math. Phys)
- [17] **T Ohtsuki**, *Invariants of 3-manifolds derived from universal invariants of framed links*, (preprint 1993)
- [18] **D E Radford**, *The trace function and Hopf algebras*, Journal of Algebra, 163 (1994) 583{622
- [19] **D E Radford**, *Generalized double crossproducts associated with quantized enveloping algebras*, (preprint)
- [20] **D E Radford**, *On Kau man's knot invariants arising from finite dimensional Hopf algebras*, from: "Advances in Hopf Algebras", Lecture Notes in Pure and Appl. Math. Vol. 148, Marcel Dekker, New York (1992) 205{266
- [21] **K Reidemeister**, *Knotentheorie* Chelsea Pub. Co., N.Y. (1948) Copyright 1932, Julius Springer, Berlin
- [22] **N Yu Reshetikhin, V G Turaev**, *Ribbon graphs and their invariants derived from quantum groups*, Commun. Math. Phys. 127 (1990) 1{26

- [23] **N Yu Reshetikhin**, *Quasitriangular Hopf Algebras and Invariants of Tangles*, Leningrad Math. J. 1 (1990) 491{513
- [24] **N Yu Reshetikhin, V G Turaev**, *Invariants of 3-manifolds via link polynomials and quantum groups*, Invent. Math. 103 (1991) 547{597
- [25] **M E Sweedler**, *Hopf Algebras*, Mathematics Lecture Notes Series, Benjamin, New York (1969)
- [26] **H Whitney**, *On regular closed curves in the plane*, Comp. Math. 4 (1937) 276{284
- [27] **E Witten**, *Quantum field theory and the Jones polynomial*, Commun. Math. Phys. 121 (1989) 351{399

*Department of Mathematics, Statistics and Computer Science
University of Illinois at Chicago
851 South Morgan Street, Chicago, IL 60607-7045, USA*

Email: kauffman@ui.c.edu

Received: 20 January 1999 Revised: 28 July 1999