

*Geometry & Topology Monographs*  
Volume 2: Proceedings of the Kirbyfest  
Pages 489{553

## Genus two Heegaard splittings of orientable three-manifolds

Hyam Rubinstein  
Martin Scharlemann

**Abstract** It was shown by Bonahon{Otal and Hodgson{Rubinstein that any two genus one Heegaard splittings of the same 3-manifold (typically a lens space) are isotopic. On the other hand, it was shown by Boileau, Collins and Zieschang that certain Seifert manifolds have distinct genus two Heegaard splittings. In an earlier paper, we presented a technique for comparing Heegaard splittings of the same manifold and, using this technique, derived the uniqueness theorem for lens space splittings as a simple corollary. Here we use a similar technique to examine, in general, ways in which two non-isotopic genus two Heegaard splittings of the same 3-manifold compare, with a particular focus on how the corresponding hyperelliptic involutions are related.

**AMS Classification** 57N10; 57M50

**Keywords** Heegaard splitting, Seifert manifold, hyperelliptic involution

### 1 Introduction

It is shown in [5], [9] that any two genus one Heegaard splittings of the same manifold (typically a lens space) are isotopic. On the other hand, it is shown in [1], [14] that certain Seifert manifolds have distinct genus two Heegaard splittings (see also Section 3 below). In [16] we present a technique for comparing Heegaard splittings of the same manifold and derive the uniqueness theorem for lens space splittings as a simple corollary. The intent of this paper is to use the technique of [16] to examine, in general, how two genus two Heegaard splittings of the same 3-manifold compare.

One potential way of creating genus two Heegaard split 3-manifolds is to "stabilize" a splitting of lower genus (see [17, Section 3.1]). But since, up to isotopy, stabilization is unique and since genus one Heegaard splittings are known to be unique, this process cannot produce non-isotopic splittings. So we may as well

restrict to genus two splittings that are not stabilized. A second way of creating a 3-manifold equipped with a genus two Heegaard splitting is to take the connected sum of two 3-manifolds, each with a genus one splitting. But (again since genus one splittings are unique) any two Heegaard splittings of the same manifold that are constructed in this way can be made to coincide outside a collar of the summing sphere. Within that collar there is one possible difference, a "spin" corresponding to the non-trivial element of  $\pi_1(RP(2))$ , where  $RP(2)$  parameterizes unoriented planes in 3-space and the spin reverses the two sides of the plane. Put more simply, the two splittings differ only in the choice of which side of the torus in one summand is identified with a given side of the splitting torus in the other summand. The first examples of this type are given in [13], [19].

These easier cases having been considered, interest will now focus on genus two splittings that are "irreducible" (see [17, Section 3.2]). It is a consequence of [7] that a genus two splitting which is irreducible is also "strongly irreducible" (see [17, Section 3.3], or the proof of Lemma 8.2 below). That is, if  $M = A \cup_P B$  is a Heegaard splitting, then any pair of essential disks, one in  $A$  and one in  $B$ , have boundaries that intersect in at least two points.

The result of our program is a listing, in Sections 3 and 4, of all ways in which two strongly irreducible genus two Heegaard splittings of the same closed orientable 3-manifold  $M$  compare. The proof that this is an exhaustive listing is the subject of the rest of the paper. What we do not know is when two Heegaard splittings constructed in the ways described are authentically different. That is, we do not have the sort of algebraic invariants which would allow us to assert that there is no global isotopy of  $M$  that carries one splitting into another. For the case of Seifert manifolds (eg [6]) such algebraic invariants can be (non-trivially) derived from the very explicit form of the fundamental group.

Any 3-manifold with a genus two Heegaard splitting admits an orientation preserving involution whose quotient space is  $S^3$  and whose branching locus is a 3-bridge knot (cf [2]). The examples constructed in Section 4 are sufficiently explicit that we can derive from them global theorems. Here are a few: If  $M$  is an atoroidal closed orientable 3-manifold then the involutions coming from distinct Heegaard splittings necessarily commute. More generally, the commutator of two different involutions can be obtained by some composition of Dehn twists around essential tori in  $M$ . Finally, two genus two splittings become equivalent after a single stabilization.

The results we obtain easily generalize to compact orientable 3-manifolds with boundary, essentially by substituting boundary tori any place in which Dehn surgery circles appear.

We expect the methods and results here may be helpful in understanding 3{bridge knots (which appear as branch sets, as described above) and in understanding the mapping class groups of genus two 3{manifolds.

The authors gratefully acknowledge the support of, respectively, the Australian Research Council and both MSRI and the National Science Foundation.

## 2 Cabling handlebodies

Embed the solid torus  $S^1 \times D^2$  in  $\mathbb{C}^2$  as  $f(z_1; z_2) = \{z_1 = 1; z_2 = g\}$ . Define a natural orientation-preserving involution  $j : S^1 \times D^2 \rightarrow S^1 \times D^2$  by  $j(z_1; z_2) = (\bar{z}_1; \bar{z}_2)$ . Notice that the fixed points of  $j$  are precisely the two arcs  $f(z_1; z_2) = \{z_1 = 1; z_2 = g\}$  and the quotient space is  $B^3$ . On the torus  $S^1 \times D^2$  the fixed points of  $j$  are the four points  $f(1; g)$ .

For any pair of integers  $(p; q) \neq (0; 0)$  we can define the  $(p; q)$  torus link  $L_{p; q} \subset S^1 \times D^2$  to be  $f(z_1; z_2) = \{z_1^p = z_2^q = g\}$ . The  $(1; 0)$  torus link is a meridian and the  $(k; 1)$  torus link is a longitude of the solid torus. A torus knot is a torus link of one component which is not a meridian or longitude. In other words, a torus knot is a torus link in which  $p$  and  $q$  are relatively prime, and neither is zero. Up to orientation preserving homeomorphism of  $S^1 \times D^2$  (given by Dehn twists) we can also assume, for a torus knot, that  $1 \leq p < q$ .

**Remark** Let  $L_{p; q} \subset S^1 \times D^2$  be a torus knot,  $\gamma$  an arc that spans the annulus  $S^1 \times D^2 - L_{p; q}$  and  $r$  be a radius of the disk  $f^{-1}(g) \subset S^1 \times D^2$ . Then the complement of a neighborhood of  $L_{p; q} \cup \gamma$  in  $S^1 \times D^2$  is isotopic to a neighborhood of  $(S^1 \times \{g\}) \cup \gamma$  in  $S^1 \times D^2$ . This fact is useful later in understanding how cabling is affected by stabilization.

Clearly  $j$  preserves any torus link  $L_{p; q}$ . If  $L_{p; q}$  is a torus knot, so  $p$  and  $q$  can't both be even, the involution  $j|_{L_{p; q}}$  has precisely two fixed points:  $(1; 1)$  and either  $(-1; -1)$ , if  $p$  and  $q$  are both odd; or  $(-1; 1)$  if  $p$  is even; or  $(1; -1)$  if  $q$  is even. This has the following consequence. Let  $N$  be an equivariant neighborhood of the torus knot  $L_{p; q}$  in  $S^1 \times D^2$ . Then  $N$  is topologically a solid torus, and the fixed points of  $j|_N$  are two arcs. That is,  $j|_N$  is topologically conjugate to  $j|_{S^1 \times D^2}$ . (See Figure 1.)

The involution  $j$  can be used to build an involution of a genus two handlebody  $H$  as follows. Create  $H$  by attaching together two copies of  $S^1 \times D^2$  along an equivariant disk neighborhood  $E$  of  $(1; 1) \subset S^1 \times D^2$  in each copy. Then

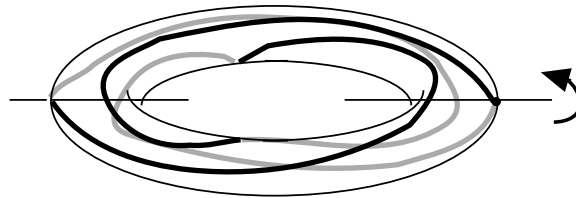

Figure 1

acting simultaneously on both copies will produce an involution of  $H$ , which we continue to denote  $\tau$ . Again the quotient is  $B^3$  but the fixed point set consists of three arcs. (See Figure 2 for a topologically equivalent picture.) We will call  $\tau$  the *standard involution* on  $H$ . It has the following very useful properties: it carries any simple closed curve in  $@H$  to an isotopic copy of the curve, and, up to isotopy, any homeomorphism of  $@H$  commutes with it. It will later be useful to distinguish involutions of different handlebodies, and since, up to isotopy rel boundary, this involution is determined by its action on  $@H$ , it is legitimate, and will later be useful, to denote the involution by  $\tau_{@H}$ .

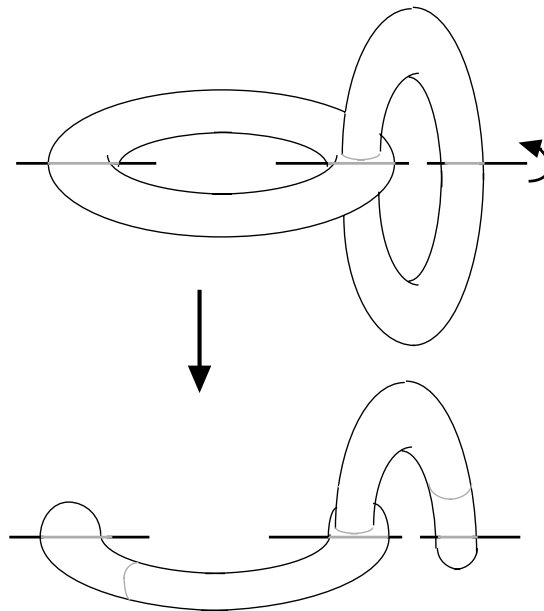

Figure 2

Two alternative involutions of the genus two handlebody  $H = (S^1 \times D^2)_1 \cup_E (S^1 \times D^2)_2$  will sometimes be useful. Consider the involution that rotates  $H$

around a diameter of  $E$ , exchanging  $(S^1 \cup D^2)_1$  and  $(S^1 \cup D^2)_2$ . (See Figure 3.) The diameter is the set of fixed points, and the quotient space is a solid torus. This will be called the *minor involution* on  $H$ . The *major involution* is best understood by thinking of  $H$  as a neighborhood of the union of two circles that meet so that the planes containing them are perpendicular, as in Figure 2. Then  $H$  is the union of two solid tori in which a core of fixed points in one solid torus coincides in the other solid torus with a diameter of a fiber. Under this identification, a full rotation of one solid torus around its core coincides in the other solid torus with the standard involution, and one of the arcs of fixed points in the second torus is a subarc of the core of the first. The quotient of this involution is a solid torus and the fixed point set is the core of the first solid torus together with an additional boundary parallel proper arc in the second solid torus. This involution will be called the *circular involution*.

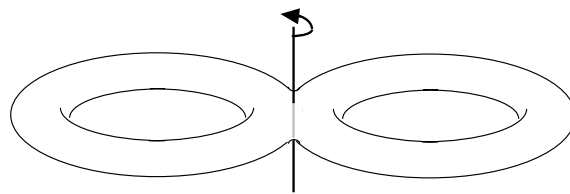

Figure 3

In analogy to definitions in the case of a solid torus, we have:

**Definition 2.1** A *meridian disk* of a handlebody  $H$  is an essential disk in  $H$ . Its boundary is a *meridian curve*, or, more simply, a meridian. A *longitude* of  $H$  is a simple closed curve in  $\partial H$  that intersects some meridian curve exactly once. A meridian disk can be separating or non-separating. Two longitudes  $\gamma, \gamma' \in \partial H$  are *separated longitudes* if they lie on opposite sides of a separating meridian disk.

There is a useful way of imbedding one genus two handlebody in another. Begin with  $H = (S^1 \cup D^2)_1 \cup_E (S^1 \cup D^2)_2$ , on which  $\tau$  operates as above. Let  $N$  be an equivariant neighborhood of a torus knot in  $(S^1 \cup D^2)_1$ . Choose  $N$  large enough (or  $E$  small enough) that  $E \cap N \subset \partial(S^1 \cup D^2)_1$ . Then  $H^0 = N \cup_E (S^1 \cup D^2)_2$  is a new genus two handlebody on which  $\tau$  continues to act. In fact  $\partial_{H^0} = \partial_H \cup H^0$ . We say the handlebody  $H^0$  is obtained by *cabling into*  $H$  or, dually,  $H$  is obtained by *cabling out of*  $H^0$ . (See Figure 4.)

There is another useful way to view cabling into  $H$ . Recall the process of Dehn surgery: Let  $q/s$  be a rational number and  $\gamma$  be a simple closed curve in a 3-manifold  $M$ . Then we say a manifold  $M^0$  is obtained from  $M$  by  $q/s$  surgery

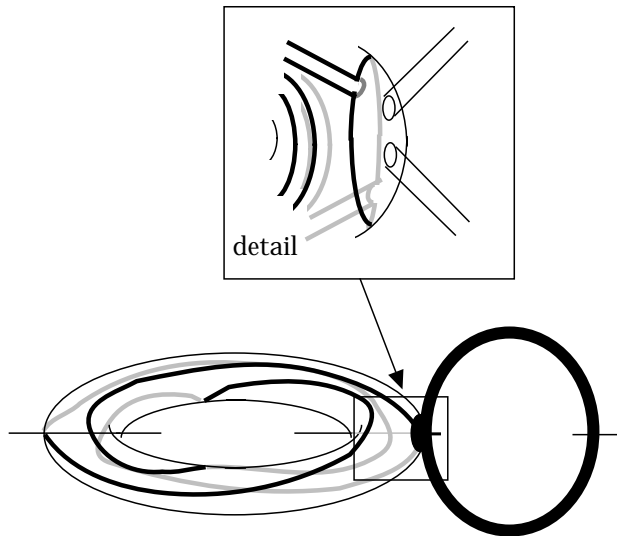

Figure 4

on if a solid torus neighborhood  $(\ )$  is removed from  $M$  and is replaced by a solid torus whose meridian is attached to  $L_{q;s} @ (\ )$ . Unless there is a natural choice of longitude for  $(\ )$  (eg when  $M = S^3$ ),  $q=s$  is only de ned modulo the integers or, put another way, we can with no loss of generality take  $0 \leq q < s$ .

If we take  $\Sigma$  to be the core  $S^1 \times \text{pt} \subset S^1 \times D^2$  and perform  $q=s$  surgery, then the result  $M^\theta$  is still a solid torus, but  $L_{q;s}$  becomes a meridian of  $M^\theta$ . The curve  $L_{p;r}$ , with  $ps - qr = 1$  becomes a longitude of  $M^\theta$ , because it intersects  $L_{q;s}$  in one point. A longitude  $L_{0;1}$  becomes the torus knot  $L_{p;q} \subset M^\theta$  because it intersects a longitude  $p$  times and a meridian  $q$  times. So another way of viewing  $H^\theta \subset H$  is this: Attach a neighborhood (containing  $E$ , but disjoint from  $(S^1 \times D^2)_1$ ) of the longitude  $(S^1 \times \text{pt})_1$  to  $(S^1 \times D^2)_2$  to form  $H^\theta$ . Then do  $q=s$  surgery to  $H$  to give  $H$  containing  $H^\theta$ . The advantage of this point of view is that the construction is more obviously equivariant (since both the longitude and the core are clearly preserved by  $\Sigma$ ) once we observe once and for all, from the earlier viewpoint (see Figure 1), that Dehn surgery is equivariant.

Of course it is also possible to cable into  $H$  via a similar construction in  $(S^1 \times D^2)_2$ , perhaps at the same time as we cable in via  $(S^1 \times D^2)_1$ .

### 3 Seifert examples of multiple Heegaard splittings

A Heegaard splitting of a closed orientable 3-manifold  $M$  is a decomposition  $M = A \cup_P B$  in which  $A$  and  $B$  are handlebodies, and  $P = \partial A = \partial B$ . In other words,  $M$  is obtained by gluing two handlebodies together by some homeomorphism of their boundaries. If the splitting is genus two, then the splitting induces an involution on  $M$ . Indeed the standard involutions of  $A$  and  $B$  can be made to coincide on  $P$ , since the standard involution on  $A$ , say, commutes with the gluing homeomorphism  $\partial A \rightarrow \partial B$ . So we can regard  $\cup_P$  as an involution of  $M$  (cf [2]).

We are interested in understanding closed orientable 3-manifolds that admit more than one isotopy class of genus two Heegaard splitting. That is, splittings  $M = A \cup_P B = X \cup_Q Y$  in which the genus two surfaces  $P$  and  $Q$  are not isotopic. (A separate but related question is whether there is an ambient homeomorphism which carries one to the other, ie, whether the splittings are homeomorphic.) In this section we begin by discussing a class of manifolds for which the answer is well understood.

It is a consequence of the classification theorem of Moriah and Schultens [15] that Heegaard splittings of closed Seifert manifolds (with orientable base and fibers) are either "vertical" or "horizontal". The consequence which is relevant here is that any such Seifert manifold which has a genus two splitting is in fact a Seifert manifold over  $S^2$  with three exceptional fibers. Through earlier work of Boileau and Otal [4] it was already known that genus two splittings of these manifolds were either vertical or horizontal and this led Boileau, Collins and Zieschang [3] and, independently, Moriah [14] to give a complete classification of genus 2 Heegaard decompositions in this case. In general, there are several.

Most (the vertical splittings) can be constructed as follows: Take regular neighborhoods of two exceptional fibers and connect them with an arc (transverse to the fiber) that projects to an imbedded arc in the base space connecting the two exceptional points, which are the projections of the exceptional fibers. Any two such arcs are isotopic, so the only choice involved is in the pair of exceptional fibers. It is shown in [3] that this choice can make a difference: different choices can result in Heegaard splittings that are not even homeomorphic.

The various vertical splittings do have one common property, however. They all share the same standard involution. All that is involved in demonstrating this is the proper construction of the involution on the Seifert manifold  $M$ . In the base space, put all three exceptional fibers on the equator of the sphere.

Now consider the orientation preserving involution of  $M$  that simultaneously reverses the direction of every fiber and reflects the base  $S^2$  through the equator (ie, exchanges the fiber lying over a point with the fiber lying over its reflection). This involution induces the natural involution on a neighborhood of any fiber that lies over the equator, specifically the exceptional fibers. If we choose two of them, and connect them via a subarc of the equator, the involution on  $M$  is the standard involution on the corresponding Heegaard splitting.

Two types of Seifert manifolds have additional splittings (see [3, Proposition 2.5]). One, denoted  $V(2;3;a)$ , is the 2-fold branched cover of the 3-bridge torus knot  $L_{(a,3)}(S^3; a=7)$ , and the other, denoted  $W(2;4;b)$ , is a 2-fold branched cover over the 3-bridge link which is the union of the torus knot  $L_{(b,2)}(S^3; b=5)$  and the core of the solid torus on which it lies. Since these are three-bridge links, there is a sphere that divides them each into two families of three unknotted arcs in  $B^3$ . The 2-fold branched cover of three unknotted arcs in  $B^3$  is just the genus two handlebody (in fact the inverse operation to quotienting out by the standard involution). So this view of the links defines a Heegaard splitting on the double-branched cover  $M$ .

In both cases the natural fibering of  $S^3$  by torus knots of the relevant slope lifts to the Seifert fibering on the double-branched cover. The torus knots lie on tori, each of which induces a genus one Heegaard splitting of  $S^3$ . The natural involution of  $S^3$  defined by this splitting (rotation about an unknot in  $S^3$  that intersects the cores of both solid tori, see [3, Figures 4 and 5]), preserves the fibering of  $S^3$  and induces the natural involution on any fiber that intersects its axis. We can arrange that the exceptional fibers (including those on which we take the 2-fold branched cover) intersect  $\gamma$ . Then the standard involution of  $S^3$  simultaneously does three things. It induces the standard involution  $\rho$  on  $M$  that comes from its vertical Heegaard decomposition  $M = A \cup_{\rho} B$ ; it preserves the 3-bridge link  $L \subset S^3$  that is the image of the fixed point set of the other involution  $\sigma$ ; and it preserves the sphere which lifts to the other Heegaard surface  $Q \subset M = X \cup_Q Y$ , while interchanging  $X$  and  $Y$ . It follows easily that  $\rho$  and  $\sigma$  commute.

The product of the two involutions is again the standard involution, but with a different axis of symmetry. To see how this can be, note that the involution  $\sigma$  is in fact just a flow of  $\gamma$  along each regular fiber and also along the exceptional fibers other than the branch fibers. Since the branch fibers have even index, a flow of  $\gamma$  on regular fibers induces the identity on the branch fibers. So in fact  $\sigma$  is isotopic to the identity (just flow along the fibers). The fixed point set of  $\rho$  intersects any exceptional fiber in two points,  $\delta$  apart; indeed it is a reflection of the fiber across those two fixed points. Hence  $\sigma$  carries the fixed



point set of  $P$  to itself and the involutions commute. The composition  $P \circ Q$  is also a reflection in each exceptional fiber but through a pair of points which differ by  $\pi/2$  from the points across which, in an exceptional fiber,  $P$  reflects. See Figure 5.

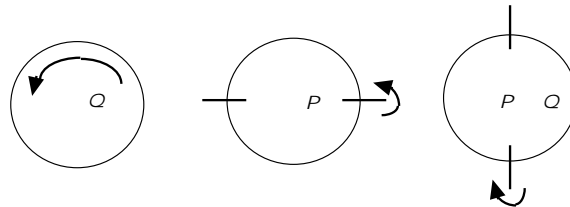

Figure 5

## 4 Other examples of multiple Heegaard splittings

In this section we will list a number of ways of constructing 3-manifolds  $M$ , not necessarily Seifert manifolds, which support multiple genus two Heegaard splittings. That is, it will follow from the construction that  $M$  has two or more Heegaard splittings which are at least not obviously isotopic. The constructions are elementary enough that in all cases it will be easy to see that a single stabilization suffices to make them isotopic. (We will only rarely comment on this stabilization property.) They are symmetric enough that in all cases we will be able to see directly how the corresponding involutions of  $M$  are related. When  $M$  contains no essential separating tori then, in many cases, the involutions from the different Heegaard splittings will be the same and, in all cases, the involutions will at least commute. When  $M$  does contain essential separating tori, the same will be true after possibly some Dehn twists around essential tori.

**Definition 4.1** Suppose  $T^2 \subset M$  is a collar of an essential torus in a compact orientable 3-manifold  $M$ . Then a homeomorphism  $h: M \rightarrow M$  is obtained by a Dehn twist around  $T^2$  if  $h$  is the identity on  $M - (T^2 \times I)$ .

Ultimately we will show that any manifold that admits multiple splittings will do so because the manifold, and any pair of different splittings, appears on the list below. This will allow us to make conclusions about how the involutions determined by multiple splittings are related. What we are unable to determine is when the examples which appear here actually do give non-isotopic splittings.

For this one would need to demonstrate that there is no *global* isotopy of  $M$  carrying one splitting to another. This requires establishing a property of the splitting that is invariant under Nielsen moves and showing that the property is different for two splittings. For example, the very rich structure of Seifert manifold fundamental groups was exploited in [3] to establish that some splittings were even globally non-isotopic.

Alternatively, as in [1], one could show that the associated involutions have fixed sets which project to inequivalent knots or links in  $S^3$ . Note that non-isotopic splittings can probably arise even when the associated involutions have fixed sets projecting to the same knots or links in  $S^3$ . In this case, there would be inequivalent 3{bridge representations of these knots or links.

#### 4.1 Cablings

Consider the graph  $S^2 \times S^3$  consisting of two orthogonal polar great circles. One polar circle will be denoted  $e_a$  and the other will be thought of as two edges  $e_a$  and  $e_b$  attached to  $S^2$ . The full rotation  $\pi : S^3 \rightarrow S^3$  about the equator of  $S^2$  preserves  $S^3$ . (Here "full rotation" means this: Regard  $S^3$  as the join of  $S^2$  with another circle, and rotate this second circle half-way round.) Without changing notation, thicken  $S^3$  equivariantly, so it becomes a genus three handlebody and note that on the two genus two sub-handlebodies  $[e_a$  and  $[e_b$ ,  $\pi$  restricts to the standard involution.

Now divide the solid torus  $S^3$  in two by a longitudinal annulus  $A$  perpendicular to  $S^2$ . The annulus  $A$  splits  $S^3$  into two solid tori  $T_a$  and  $T_b$ . Both ends of the 1{handle  $e_a$  are attached to  $T_a$  and both ends of  $e_b$  to  $T_b$ . Define genus two handlebodies  $A$  and  $B$  by  $A = T_a [ e_a$  and  $B = T_b [ e_b$ . Then  $\pi$  preserves  $A$  and  $B$  and on them restricts to the standard involution. Finally, construct a closed 3{manifold  $M$  from  $T_a$  and  $T_b$  by gluing  $\partial A - A$  to  $\partial B - A$  by any homeomorphism (rel boundary). Such a 3{manifold  $M$  and genus two Heegaard splitting  $M = A [_{\rho} B$  is characterized by the requirement that a longitude of one handlebody is identified with a longitude of the other. See Figure 6.

**Question** Which 3{manifolds have such Heegaard splittings?

So far we have described a certain kind of Heegaard splitting, but have not exhibited multiple splittings of the same 3{manifold. But such examples can easily be built from this construction: Let  $\gamma_a$  and  $\gamma_b$  be the core curves of  $T_a$  and  $T_b$  respectively.

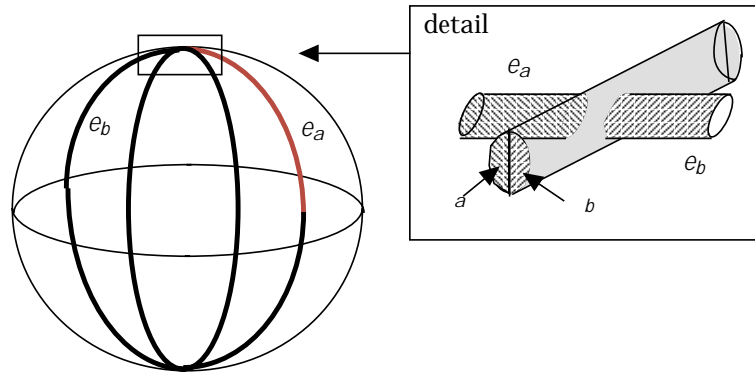

Figure 6

**Variation 1** Alter  $M$  by Dehn surgery on  $a$ , and call the result  $M^\theta$ . The splitting surface  $P$  remains a Heegaard splitting surface for  $M^\theta$ , but now a longitude of  $B^\theta = B$  is attached to a twisted curve in  $@A^\theta$ . Since  $a$  and  $b$  are parallel in  $M$ , we could also have gotten  $M^\theta$  by the same Dehn surgery on  $b$ . But the isotopy from  $a$  to  $b$  crosses  $P$ , so the splitting surface is apparently different in the two splittings. In fact, one splitting surface is obtained from the other by cabling out of  $B^\theta$  and into  $A^\theta$ . It follows from the Remark in Section 2 that the two become equivalent after a single stabilization.

**Variation 2** Alter  $M$  by Dehn surgery on both  $a$  and  $b$  and call the result  $M^\theta$ . (Note that  $M^\theta$  then contains a Seifert submanifold.) In the annulus  $A$  separates the two singular fibers  $a$  and  $b$ . New splitting surfaces for  $M^\theta$  can be created by replacing  $A$  by any other annulus that separates the singular fibers and has the same boundary. There are an integer's worth of choices, basically because the braid group  $B_2 = \mathbf{Z}$ . Equivalently, alter  $P$  by Dehn twisting around the separating torus  $@$ .

### 4.2 Double cablings

Just as the previous example of symmetric cabling is a special case of Heegaard splittings, so the example here of double cablings is a special case of the symmetric cabling above, with additional parts of the boundaries of  $A$  and  $B$  identified.

Consider the graph in  $S^2 \times S^3$  consisting of two circles  $n$  and  $s$  of constant latitude, together with two edges  $e_a$  and  $e_b$  spanning the annulus

between them in  $S^2$ . Both  $e_a$  and  $e_b$  are segments of a polar great circle. The full rotation  $\rho : S^3 \rightarrow S^3$  about  $S^2$  preserves  $S^2$ . Without changing notation, thicken  $S^2$  equivariantly, so it becomes a genus three handlebody and note that on the two genus two sub-handlebodies  $n \cup e_a \cup s$  and  $n \cup e_b \cup s$ ,  $\rho$  restricts to the standard involution.

Now remove from both  $n$  and  $s$  annuli  $A_n$  and  $A_s$  respectively, chosen so that the boundary of each of the annuli is the  $(2;2)$  torus link in the solid torus. That is, each boundary component is the  $(1;1)$  torus knot, where a preferred longitude of the solid torus  $n$  or  $s$  is that determined by intersection with  $S^2$ . Place  $A_n$  and  $A_s$  so that they are perpendicular to  $S^2$  at the points where the edges  $e_a$  and  $e_b$  are attached. Then  $A_n$  divides  $n$  into two solid tori, one of them  $na$  attached to one end of  $e_a$  and the other  $nb$  attached to an end of  $e_b$ . The annulus  $A_s$  similarly divides the solid torus  $s$ .

Define genus two handlebodies  $A$  and  $B$  by  $A = na \cup e_a \cup sa$  and  $B = nb \cup e_b \cup sb$ . Then  $\rho$  preserves  $A$  and  $B$  and on them restricts to the standard involution. Finally, construct a closed 3-manifold  $M$  from  $A$  and  $B$  by gluing  $\partial A - (A_n \cup A_s)$  to  $\partial B - (A_n \cup A_s)$  by any homeomorphism (rel boundary). Such a 3-manifold  $M$  and genus two Heegaard splitting  $M = A \cup_\rho B$  is characterized by the requirement that two separated longitudes of one handlebody are identified with two separated longitudes of the other. See Figure 7.

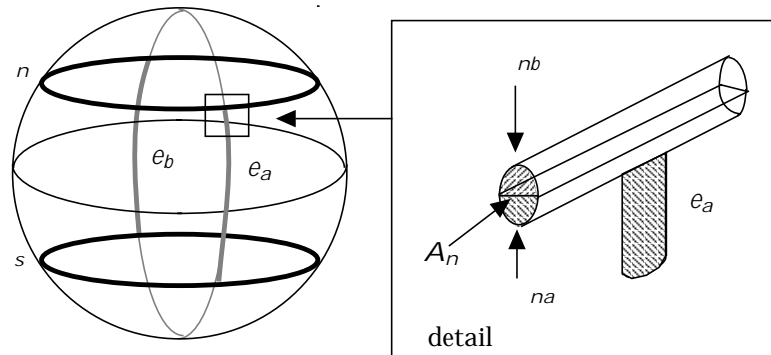

Figure 7

**Question** Which 3-manifolds have such Heegaard splittings?

Just as in example 4.1, manifolds with multiple Heegaard splittings can easily be built from this construction:

**Variation 1** Let  $\gamma_{na}, \gamma_{nb}, \gamma_{sa}, \gamma_{sb}$  be the core curves of  $\gamma_{na}, \gamma_{nb}, \gamma_{sa}$  and  $\gamma_{sb}$  respectively. Do Dehn surgery on one or more of these curves, changing  $M$  to  $M^\theta$ . If a single Dehn surgery is done in  $\gamma_n$  and/or  $\gamma_s$  then there is a choice on which of the possible core curves it is done. If two Dehn surgeries are done in  $\gamma_n$  and/or  $\gamma_s$  then there is an integer's worth of choices of replacements for  $A_n$  and/or  $A_s$ , corresponding to Dehn twists around  $\gamma_n$  and/or  $\gamma_s$ . Up to such Dehn twists, all these Heegaard splittings induce the same natural involution on  $M^\theta$ .

**Variation 2** Let  $\gamma_a$  be a simple closed curve in the 4 punctured sphere  $S^2 \setminus \{4\text{ points}\}$  with the property that  $\gamma_a$  intersects the separating meridian disk orthogonal to  $e_a$  exactly twice and a meridian disk of each of  $\gamma_{na}$  and  $\gamma_{sa}$  in a single point. Similarly define  $\gamma_b$ . Suppose the gluing homeomorphism  $h: S^2 \setminus \{4\text{ points}\} \rightarrow S^2 \setminus \{4\text{ points}\}$  has  $h(\gamma_a) = \gamma_b$ , and call the resulting curve  $\gamma$ .

Push  $\gamma$  into  $A$  and do any Dehn surgery on the curve. Since  $\gamma$  is a longitude of  $A$  the result is a handlebody. Similarly, if the curve were pushed into  $B$  before doing surgery, then  $B$  remains a handlebody. So this gives two alternative splittings. But this is not new, since this construction is obviously just a special case of a single cabling (Example 4.1). However, if we do surgery on the curve after pushing into  $A$  and simultaneously do surgery on one or both of  $\gamma_{nb}$  and  $\gamma_{sb}$  we still get a Heegaard splitting. Now push  $\gamma$  into  $B$  and simultaneously move the other surgeries to  $\gamma_{na}$  and/or  $\gamma_{sa}$  and get an alternative splitting.

### 4.3 Non-separating tori

Let  $\gamma_n, \gamma_s, A_n, A_s$  and the four core curves  $\gamma_{na}, \gamma_{nb}, \gamma_{sa}, \gamma_{sb}$  be defined as they were in the previous case, Example 4.2, but now consider the  $\pi$ -rotation that rotates  $S^3$  around the equator of  $S^2$ . This involution preserves  $\gamma_n$  and the 1-handles  $e_a$  and  $e_b$ , but it exchanges north and south, so  $\gamma_s$  is exchanged with  $\gamma_n$ , and  $A_n$  with  $A_s$ . Remove small tubular neighborhoods of core curves  $\gamma_n$  and  $\gamma_s$  of the solid tori  $\gamma_n$  and  $\gamma_s$ , and with them small core sub-annuli of  $A_n$  and  $A_s$ . Choose these neighborhoods so that they are exchanged by  $\pi$  and call their boundary tori  $T_n$  and  $T_s$ . Attach  $T_n$  to  $T_s$  by an orientation reversing homeomorphism  $h$  that identifies the annulus  $T_n \setminus \gamma_{na}$  with  $T_s \setminus \gamma_{sa}$  and the annulus  $T_n \setminus \gamma_{nb}$  with  $T_s \setminus \gamma_{sb}$ . Choose  $h$  so that the orientation reversing composition  $\pi \circ h: T_n \rightarrow T_n$  fixes two meridian circles,  $\gamma_+$  and  $\gamma_-$ , lying respectively on the meridian disks of  $\gamma_n$  at which  $e_a$  and  $e_b$  are attached. The resulting manifold  $M_\pi$  is orientable and, in fact, is homeomorphic to  $T^2 \times I$  with two 1-handles attached. Let  $T$  be the non-separating torus which

is the image of  $T_s$  (and so also  $T_n$ ). Also denote by  $a$  the two arcs of intersection of  $T_+$  and  $T_-$  with  $A$ ; these arcs lie on the longitudinal annulus  $A \setminus T$ . Similarly denote the two arcs  $T \setminus B$  by  $b$ . See Figure 8.

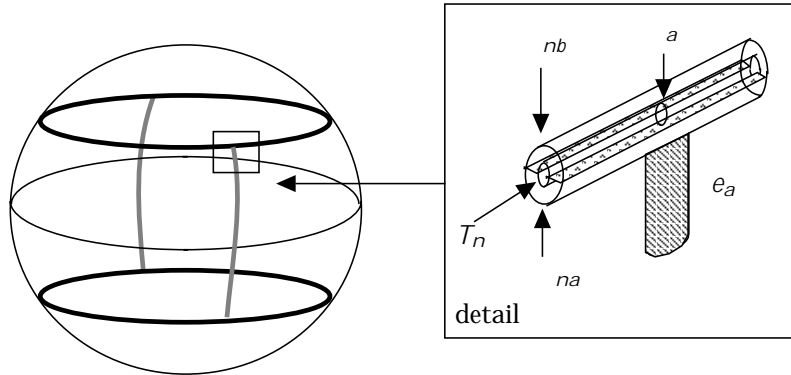

Figure 8

Note that in  $T$  the union of  $e_a$ ,  $na$ , and  $sa$  is a genus two handlebody  $A$  that intersects  $T$  in a longitudinal annulus. Similarly, the remainder is a genus two handlebody  $B$  that also intersects  $T$  in a longitudinal annulus. The involution  $\rho$  acts on  $T$ , preserves  $T$  (exchanging its two sides and fixing the two meridians  $na, nb$ ), and preserves both  $A$  and  $B$ . The fixed points of the involution on  $A$  consist of the arc  $T \setminus e_a$  and also the two arcs  $a$ . It is easy to see that this is the standard involution on  $A$ , and, similarly,  $\rho|_B$  is the standard involution. Now glue together the 4-punctured spheres  $A \setminus @$  and  $B \setminus @$  by any homeomorphism rel boundary. The resulting 3-manifold  $M$  and genus two Heegaard splitting  $M = A \cup_\rho B$  has standard involution  $\rho$  induced by  $\rho$ . The splitting is characterized by the requirement that two distinct longitudes of one handlebody, coannular within the handlebody, are identified with two similar longitudes of the other.

**Question** Which 3-manifolds have such Heegaard splittings?

Much as in the previous examples, manifolds with multiple Heegaard splittings can be built from this construction:

**Variation 1** We can assume that the deleted neighborhoods of  $na$  and  $sa$  in the construction of  $M$  above were small enough to leave the parallel core curves  $na, nb, sa, sb$  intact. Do Dehn surgery on  $na$  (or, equivalently,  $sa$ ), changing  $M$  to  $M^\theta$ . The same manifold  $M^\theta$  can be obtained by doing the

same Dehn surgery to  $\partial_{nb}$  (or, equivalently,  $\partial_{sb}$ ), but the Heegaard splittings are not obviously isotopic, for they differ by cabling into  $A$  and out of  $B$ .

**Variation 2** Do Dehn surgery on both  $\partial_{na}$  and  $\partial_{nb}$  (or, equivalently, both  $\partial_{sa}$  and  $\partial_{sb}$ ), changing  $M$  to  $M^\theta$ . This inserts two singular fibers in the collar  $T^2 \setminus I$  between  $\partial_s$  and  $\partial_n$  and these are separated by two spanning annuli, the remains of the annuli  $A_n$  and  $A_s$  glued together. View this region as a Seifert manifold, with two exceptional fibers, over the annulus  $S^1 \setminus I$ . Let  $p_a, p_b$  denote the projections of the two exceptional fibers to the annulus  $S^1 \setminus I$ . The spanning annuli project to two spanning arcs in  $(S^1 \setminus I) - \{p_a, p_b\}$ . There is a choice of such spanning arcs, and so of spanning annuli between  $\partial_s$  and  $\partial_n$  that still produce a Heegaard splitting. The choices of arcs all differ by braid moves in  $(S^1 \setminus I) - \{p_a, p_b\}$ , and these correspond to Dehn twists around essential tori in  $M^\theta$ .

**Variation 3** This variation does not involve Dehn surgery. Let  $R_A$  be the long rectangle that cuts the 1-handle  $e_a$  down the middle, intersecting every disk fiber of  $e_a$  in a single diameter, always perpendicular to  $S^2$ . Extend  $R_A$  by attaching meridian disks of  $\partial_{na}$  and  $\partial_{nb}$  so the ends of  $R_A$  become identified to  $\partial_{+a}$ . Since the identification is orientation reversing,  $R_A$  becomes a Möbius band in  $A$ , corresponding to the Möbius band spanned by  $L_{1,2}$  in one of the solid tori summands of  $A$ . Define  $R_B$  similarly, but add a half-twist, so that  $R_B$  becomes a non-separating longitudinal annulus in  $B$ .

Now construct  $M$  as above, choosing a gluing homeomorphism  $\partial A \setminus \partial \rightarrow \partial B \setminus \partial$  so that  $R_A \setminus \partial$  ends up disjoint from  $R_B \setminus \partial$ . There are an integer's worth of possibilities for this gluing, corresponding to Dehn twists around the annulus complement of the two spanning arcs of  $R_A$  in the 4-punctured sphere  $\partial A \setminus \partial$ . The four arcs of  $R_A$  and  $R_B$  divide the 4-punctured sphere into two disks.

Let  $Y$  be the genus 2 handlebody obtained from  $B$  in two steps: First remove a collar neighborhood of the annulus  $R_B$ , cutting  $B$  open along a longitudinal annulus. At this point  $\tau$  is the minor involution on  $Y$ , since the half-twist in  $R_B$  means that it contains the arc  $\partial \setminus e_b$  as well as the arc  $\partial_{+a}$ . To get the standard involution on  $Y$ ,  $\tau$  rotate around an axis in  $S^3$  perpendicular to  $S^2$  and passing through the points where  $\partial$  intersects the cores of  $e_a$  and  $e_b$ . Call this rotation  $\rho$ . Two arcs of fixed points lie in the disk fiber (now split in two) where  $e_b$  crosses  $\partial$ . A third arc of fixed points, more difficult to see, is what remains of a core of the annulus  $T \setminus A$ , once a neighborhood of  $\partial_{+a}$  is removed.

Next attach a neighborhood of the Möbius band  $R_A$  to  $Y$ . One can see that it is attached along a longitude of  $Y$ , so the effect is to cable out of  $Y$  into its complement.  $Y$  remains a handlebody. Moreover,  $\tau$  still induces the standard involution on  $Y$ .

Similarly, if a neighborhood of  $R_A$  is removed from  $A$  the effect is to cable into  $A$  and if a neighborhood of  $R_B$  is then attached the result is still a handlebody  $X$ . The Heegaard decomposition  $M = X \cup_Q Y$  has standard involution  $Q$  induced by  $\tau$ , since  $Y$  did. Notice that  $\tau$  and  $\rho$  commute, with product  $\rho\tau$ , so  $\rho$  and  $Q$  commute. The product involution  $\rho Q$  has fixed point set in  $B$  (resp.  $X$ ) the core circle of  $R_B$  and an additional arc which crosses  $a-b$  in a single point. That is, it is the "circular involution" on both handlebodies (and also on  $A$  and  $Y$ ).

#### 4.4 $K_4$ examples

Let  $K_4$  denote the complete graph on 4 vertices. Construct a complex  $\Sigma$ , isomorphic to  $K_4$ , in  $S^2$  as follows. Let  $a$  denote the equator and  $a_i, b$  two orthogonal polar great circles. Let the edge  $e_a$  be the part of  $a$  lying in the upper hemisphere and the edge  $e_b$  be the part of  $b$  that lies in the lower hemisphere. Then take  $\Sigma = [e_a] \cup [e_b]$ . Without changing notation, thicken equivariantly, so it becomes a genus three handlebody. See Figure 9.

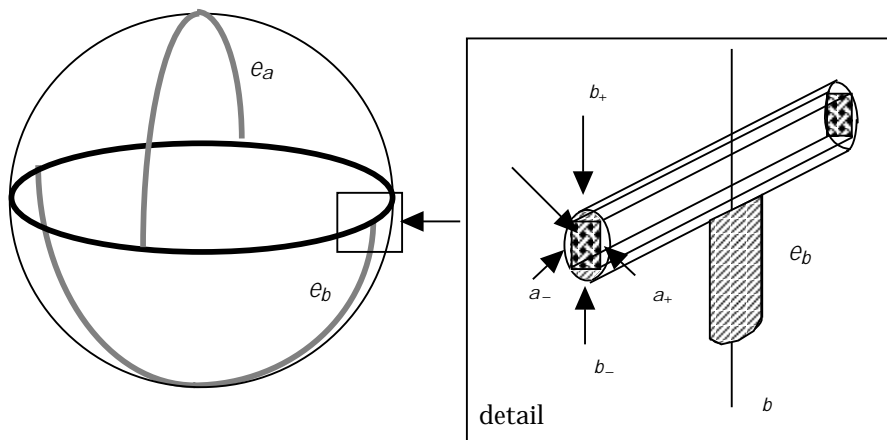

Figure 9

Consider the two  $\{$ rotations  $a_i, b$  that rotate  $S^3$  around, respectively, the curves  $a_i, b$ . Both involutions preserve  $\Sigma$  and preserve also the individual



parts  $\tau_a; e_a$  and  $e_b$ . Notice that  $\tau_a$  induces the minor involution on the genus two handlebody  $A_+ [ e_a$  and the standard involution on the genus two handlebody  $A_- [ e_b$ . The symmetric statement is true for  $\tau_b$ .

Consider the link  $L_{4,4}$  in  $S^3$ . The link intersects any meridian disk of  $S^3$  in four points. Let  $\tau_a$  denote the inscribed "square" torus ( $S^1 \times S^1$  square) which, in each meridian disk of  $S^3$ , is the convex hull of those four points. The complementary closure of  $\tau_a$  in  $S^3$  consists of four solid tori. Isotope  $L_{4,4}$  so that two of the complementary solid tori,  $A_+$  and  $A_-$ , lying on opposite sides of  $\tau_a$  are attached to  $e_a$ , each to one end of  $e_a$ . The other two,  $B_+$  and  $B_-$  are then similarly attached to  $e_b$ . Notice that, paradoxically,  $\tau_a$  now induces the standard involution on the genus two handlebody  $A_+ = A_+ [ e_a$  and the minor involution on the genus two handlebody  $B_- = B_- [ e_b$ . The latter is because  $\tau_a$  is disjoint from both of  $B_+$  and  $B_-$  and so only intersects the handlebody in a diameter of a meridian disk of  $e_b$ . The symmetric statements are of course true for  $\tau_b$ . Finally, let  $M$  be a 3-manifold obtained by gluing together the 4-punctured spheres  $A_+ \setminus \partial$  and  $B_- \setminus \partial$  by any homeomorphism rel boundary. Note that so far we have not identified any Heegaard splitting of  $M$ , since  $\tau_a$  is in neither  $A_+$  nor  $B_-$ .

**Variation 1** Let  $A = A_+$  and  $B = B_- [ \tau_a$ . Then  $M = A [_{\rho} B$  is a Heegaard splitting, on which  $\tau_a$  is the standard involution. Indeed, we've already seen that  $\tau_a$  is standard on  $A = A_+$  and it is standard on  $B$  since  $\tau_a$  passes twice through  $B$ , as well as once through  $e_b$ . Alternatively, let  $X = A_- [ \tau_a$  and  $Y = B_+$ . Then, for exactly the same reasons,  $M = X [_{\sigma} Y$  is a Heegaard splitting, on which  $\tau_b$  acts as the standard involution. Notice that  $\tau_a$  and  $\tau_b$  commute. Their product is rotation about the circle perpendicular to  $S^2$  through the poles. This is the minor involution on both  $A$  and  $B$ . It follows that  $\rho$  and  $\sigma$  commute and their product operates as the minor involution on all four of  $A; B; X; Y$ .

**Variation 2** Let  $M^0$  be obtained by a Dehn surgery on the core of  $\tau_a$ . The constructions of Variation 1 give two Heegaard splittings of  $M^0$  as well, with commuting standard involutions. But more splittings are available as well:  $A$  could be cabled into  $B$  in two different ways, essentially by moving the Dehn surgered circle into either of  $A_+$ . Similarly  $Y$  could be cabled into  $X$ . Since such cablings have the same standard involution, the various alternatives give involutions which either coincide or commute.

**Variation 3** Let  $M^0$  be obtained by Dehn surgery on two parallel circles in  $S^3$ . These can be placed in a variety of locations and still we would have Heegaard

splittings: If at most one is placed as a core of  $a_+$  or  $a_-$  and the other is left in  $\Sigma$ , then still  $M^\theta = A^\theta [_{P^\theta} B^\theta$  is a Heegaard splitting. Similarly if one is put in  $a_+$  and the other in  $a_-$ . In both cases the splittings can additionally be altered by Dehn twists around the now essential torus  $@$ . We could similarly move one or both of the two surgery curves into  $b$  to alter the splitting  $M^\theta = X^\theta [_{Q^\theta} Y^\theta$ . Finally, we could move one into  $a$  and the other into  $b$ . Then respectively  $A^\theta [_{P^\theta} B^\theta$  and  $X^\theta [_{Q^\theta} Y^\theta$  are alternative splittings.

**Variation 4** Let  $M^\theta$  be obtained by Dehn surgery on three parallel circles in  $\Sigma$ . If one is placed in each of  $a_+$  and  $a_-$  and the third is left in  $\Sigma$  we still have a Heegaard splitting  $M^\theta = A^\theta [_{P^\theta} B^\theta$ . Moreover, there is then a choice of how the pair of annuli  $P^\theta \setminus \Sigma$  lie in  $\Sigma$ . The surgeries change  $\Sigma$  into a Seifert manifold over a disk, with three exceptional fibers lying over singular points  $p_{a_+}, p_{a_-}$  and  $p$ . The annuli  $P^\theta \setminus \Sigma$  lie over proper arcs in the disk, which can be altered by braid moves on the singular points. These braid moves translate to Dehn twists about essential tori in  $M^\theta$ . We could similarly arrange the three surgery curves with respect to  $b$  to alter the splitting  $M^\theta = X^\theta [_{Q^\theta} Y^\theta$ .

**Variation 5** Let  $a$  be a simple closed curve in the 4 punctured sphere  $@A_- \setminus @$  with the property that  $a$  intersects the separating meridian disk orthogonal to  $e_a$  exactly twice and a meridian disk of each of  $a$  in a single point. Similarly define  $b$ . Suppose the gluing homeomorphism  $h: @A_- \setminus @ \rightarrow @B_- \setminus @$  has  $h(a) = b$ .

Push  $a$  into  $A_-$  and do any Dehn surgery on the curve. Since  $a$  is a longitude of  $A_-$  the result is a handlebody  $A^\theta$ . The complement is the handlebody  $B$  of Variation 1. On the other hand, if the curve (identified with  $b$ ) were pushed into  $B_-$  before doing surgery, then  $B_-$  remains a handlebody  $Y^\theta$  and its complement is the handlebody  $X$  of Variation 1. So this pair of alternative splittings,  $M = A^\theta [_{P^\theta} B = X [_{Q^\theta} Y^\theta$ , is in some sense a variation of variation 1.

**Variation 6** Just as Variation 5 is a modified Variation 1, here we modify Variations 2 and 3. Suppose curves  $a$  and  $b$  are identified as in Variation 5, and do Dehn surgery on this curve. But also do another Dehn surgery on one or two curves parallel to the core of  $\Sigma$ , as in Variation 2. If  $\Sigma$  is pushed into  $A_-$  and at most one of the other Dehn surgery curves is put in each of  $A$  and  $B$  then  $A^\theta [_{P^\theta} B^\theta$  is a Heegaard splitting. If  $\Sigma$  is pushed into  $B_-$  and at most one of the other Dehn surgery curves is put in each of  $X$  and  $Y$ , then  $X^\theta [_{Q^\theta} Y^\theta$  is a Heegaard splitting.

**Variation 7** Topologically,  $\Sigma = S^1 \times D^2$ ; choose a framing so that  $L_{1,1}$   $@$  is identified with  $S^1 \times \text{point}$ . Remove the interior of  $\Sigma$  from  $\Sigma$  and

identify  $@ = S^1 \times @D^2$  to itself by an orientation reversing involution that is a reflection in the  $S^1$  factor and a rotation in  $@D^2$ . In particular identifies the two longitudinal annuli  $A_- \setminus @$  (resp.  $B_- \setminus @$ ). Hence, after the identification given by  $\tau$ ,  $A_-$  (resp.  $B_-$ ) becomes a genus two handlebody  $A$  (resp.  $B$ ). A closed 3-manifold can then be obtained by gluing together the 4-punctured spheres  $@A_- \setminus @$  and  $@B_- \setminus @$  by any homeomorphism rel boundary. Equivalently, the closed manifold  $M$  is obtained from an  $M_-$  (with boundary a torus) constructed as in the initial discussion above by identifying the torus  $@M_-$  to itself by an orientation reversing involution. The quotient of the torus is a Klein bottle  $K \times M$ , whose neighborhood typically is bounded by the canonical torus of  $M$ .

To create from this variation examples of a single manifold with multiple splittings, apply the same trick as in earlier variations: Do Dehn surgery on the core curve of  $b_+$  (equivalently  $b_-$ ) and/or the core curve of  $a_+$  (equivalently  $a_-$ ). If we do the surgery on one curve (so the set of canonical tori becomes a torus cutting off a Seifert piece, fiber over the Möbius band with one exceptional fiber) then there is a choice of whether the curve lies in  $A_-$  or  $B_-$ . If we do surgery on two curves (so the Seifert piece fibers over the Möbius band with two exceptional fibers) then there is a choice of which vertical annulus in the Seifert piece becomes the intersection with the splitting surface. In the former case the standard involutions of the two splittings are the same and in the latter they differ by Dehn twists about an essential torus.

## 5 Essential annuli in genus two handlebodies

It's a consequence of the classification of surfaces that on an orientable surface of genus  $g$  there is, up to homeomorphism, exactly one non-separating simple closed curve and  $[g-2]$  separating simple closed curves. For the genus two surface  $F$ , this means that each collection of disjoint simple closed curves is determined up to homeomorphism by a 4-tuple of non-negative integers:  $(a; b; c; d)$  where  $a + b + c + d = 0$  (see Figure 10). Denote this 4-tuple by  $I( )$ .

Any collection of simple closed curves might occur as the boundary of some disks in a genus two handlebody and any collection of an even number of curves might also occur as the boundary of some annuli in a genus two handlebody, just by taking  $@$ -parallel annuli or tubing together disks. To avoid such trivial constructions define:

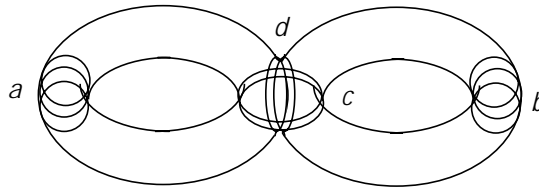

Figure 10

**Definition 5.1** A properly imbedded surface  $S$  in a compact orientable 3-manifold  $M$  is *essential* if  $S$  is incompressible and no component of  $S$  is  $\partial$ -parallel.

**Lemma 5.2** Suppose  $A \subset H$  is a collection of disjoint essential annuli in a genus 2 handlebody  $H$ . Then  $I(\partial A) = (k; l; 0; 0)$  where  $l \geq 0$  and  $k + l$  is even.

**Proof** Since  $A \subset H$  is incompressible, it is  $\partial$ -compressible. Let  $D$  be the disk obtained by a single  $\partial$ -compression. Note that the effect of the  $\partial$ -compression on  $\partial A$  is to band sum two distinct curves together. The band cannot lie in an annulus in  $\partial H$  between the curves, since  $A$  is not  $\partial$ -parallel. So if  $I(\partial A) = (k; l; m; 0); m > 0$  or  $(k; l; 0; n); n > 0$ , the band must lie in a pair of pants component of  $\partial H - \partial A$ . In that case  $\partial D$  would be parallel to a component of  $\partial A$ , contradicting the assumption that  $A$  is incompressible.

Finally,  $k + l$  is even since each component of  $A$  has two boundary components.  $\square$

**Lemma 5.3** Suppose  $S \subset H$  is an essential oriented properly imbedded surface in a genus 2 handlebody  $H$  and  $\chi(S) = -1$ . Suppose that  $[S]$  is trivial in  $H_2(H; \partial H)$ , and that no component of  $S$  is a disk. Then  $I(\partial A) = (k; l; 1; 0)$  or  $(k; l; 0; 1)$ .

**Proof**  $S$  is  $\partial$ -compressible, but the first  $\partial$ -compression can't be of an annulus component. Indeed, the result of such a  $\partial$ -compression would be an essential disk in  $H$  disjoint from  $S$ . If we cut open along this disk, it would change  $H$  into either one or two solid tori. But the only incompressible surfaces that can be imbedded in a solid torus are the disk and the annulus, so  $\chi(S) = 0$ , a contradiction. We conclude that the first  $\partial$ -compression is along a component  $S_0$  with  $\chi(S_0) = -1$ .

After  $\partial$ -compression  $S_0$  becomes an annulus  $A$ . If  $A$  were  $\partial$ -parallel then the part of  $S_0$  which was  $\partial$ -compressed either lies in the region of parallelism

or outside it. In the former case,  $S_0$  would have been compressible and in the latter case it would have been  $\partial$ -parallel. Since neither is allowed, we conclude that  $A$  is not  $\partial$ -parallel. So after the  $\partial$ -compression the surface becomes an essential collection of disjoint annuli, and Lemma 5.2 applies.

We now examine the possibilities other than those in the conclusion and deduce a contradiction in each case.

**Case 1**  $l(@S) = (k; l; 0; n); n > 1$ .

The  $\partial$ -compression is into one of the complementary components and can reduce  $n$  by at most 1. So after the  $\partial$ -compression the last coordinate is still non-trivial, contradicting Lemma 5.2.

**Case 2**  $l(@S) = (k; l; m; 0); m > 1$ .

Since  $k + l = m$  the complementary components are annuli and two pairs of pants. The  $\partial$ -compression then reduces  $m$  by at most one, yielding the same contradiction to Lemma 5.2.

**Case 3**  $l(@S) = (k; l; 0; 0)$ .

Since  $\langle S \rangle = -1$ ,  $k + l$  is odd, hence either  $k$  or  $l$  is odd. Then there is a simple closed curve in  $\partial H$  intersecting  $S$  an odd number of times, contradicting the triviality of  $[S]$  in  $H_2(H; \partial H)$ .  $\square$

**Remark** It is only a little harder to prove the same result, without the assumption that  $[S] = 0$ , but then there is the additional possibility that  $l(S) = (1; 0; 0; 0)$ .

**Definition 5.4** Suppose  $H$  is a handlebody and  $c \subset \partial H$  is a simple closed curve. Then  $c$  is *twisted* if there is a properly imbedded disk in  $H$  which is disjoint from  $c$  and, in the solid torus complementary component  $S^1 \times D^2 \subset H$  in which  $c$  lies,  $c$  is a torus knot  $L_{(p,q)}; p \geq 2$  on  $\partial(S^1 \times D^2)$ .

**Definition 5.5** A collection of annuli, all of whose boundary components are longitudes is called *longitudinal*. If all are twisted, then the collection is called *twisted*.

Figures 11{13 show annuli which are respectively longitudinal, twisted and non-separating, and twisted and separating. Displayed in the figure is an "icon" meant to schematically present the particular annulus. The icon is inspired by

imagining taking a cross-section of the handlebody near where the two solid tori are joined. The cross-section is of a meridian of the horizontal torus in the handlebody figure together with part of the vertical torus. Such icons will be useful in presenting rough pictures of how families of annuli combine to give tori in 3-manifolds.

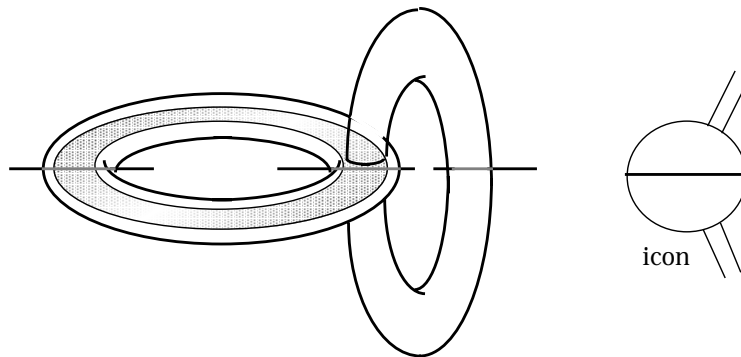

Figure 11

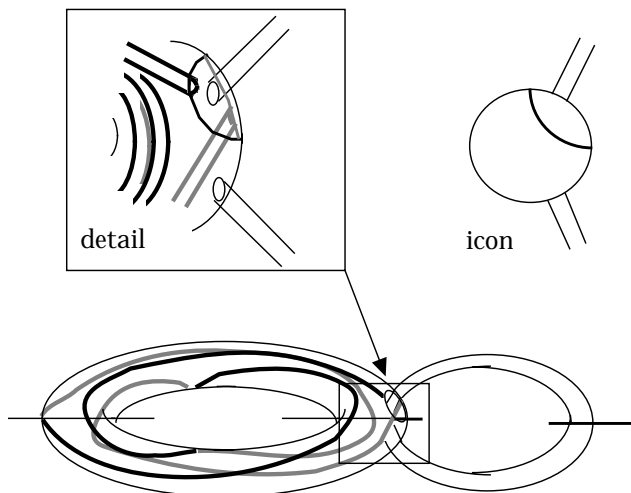

Figure 12

**Lemma 5.6** *Suppose  $A$  is a properly imbedded essential collection of annuli in a genus two handlebody  $H$ . Then the components of  $@A$  are either all twisted or all longitudes. If they are all longitudes, then the components of  $A$  are all parallel and each is non-separating in  $H$ . If they are all twisted and  $l(@A) = (k; l; 0; 0)$  then one of these two descriptions applies:*

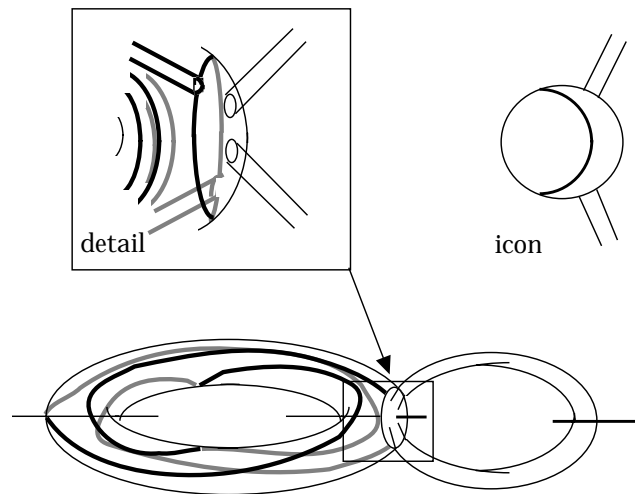

Figure 13

$A$  consists of two families of  $k=2$  and  $l=2$  parallel annuli, each annulus separates  $H$  or

$A$  consists of at most three families of parallel annuli, numbering respectively  $e; f; g \geq 0$ , with each annulus in the first two families non-separating, each annulus in the last family separating and  $e + f = l; e + f + 2g = k$ .

**Proof** By Lemma 5.2  $l(@A) = (k; l; 0; 0)$ . Let  $A^0$  denote the surface obtained from a  $@$ -compression of  $A$ , necessarily into the unique complementary component of  $@H - A$  that is a 4-punctured sphere (or twice punctured torus if  $l = 0$ ). Then  $A^0$  contains an essential disk  $D$ , and  $@D$  is disjoint from  $@A$ .

If  $D$  is a separating disk in  $H$  then the complementary solid tori contain  $A$ . Any proper annulus in a solid torus is either compressible or  $@$ -parallel, so in each solid torus component  $T$  of  $H - D$ ,  $A$  is a collection of annuli all parallel to the component of  $@T - A$  that contains  $D$ , and to no other component of  $@T - A$ . It follows that  $@A \setminus T$  consists of a collection of torus knots  $L_{(p,q)}; p \geq 2$  in  $@T$ .

If  $D$  is a non-separating disk, then  $H - D$  is a single solid torus  $T$  and all curves of  $A \setminus @T$  are parallel in  $@T$ . Each annulus is  $@$ -parallel to an annular component of  $@T - A$  that contains one of the two copies of  $D$  lying in  $@T$ . If the curves are all longitudes in  $T$  (so each annulus in  $A$  is  $@$ -parallel to both annuli of  $@T - A$ ) then the annuli must all be parallel, with a copy of  $D$  in

each of the two components of  $@T - A$  to which they are boundary parallel. If  $@T \setminus A$  consists of  $(p; q); p \geq 2$  curves then each annulus in  $A$  is boundary parallel to exactly one annulus in  $@T$ . Since  $A$  is essential, such an annulus in  $@T$  must contain either one copy of  $D$  or the other, or both copies of  $D$ . This accounts for the three families, as described. (See Figure 14.)  $\square$

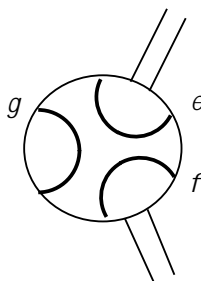

Figure 14

## 6 Canonical tori in Heegaard genus two manifolds

For  $M$  a closed orientable irreducible 3-manifold there is a (possibly empty) collection of tori, each of whose complementary components is either a Seifert manifold or contains no essential tori or annuli. A minimal such collection  $F$  of tori is called the set of *canonical tori* for  $M$  and is unique up to isotopy [11, Chapter IX].

Suppose  $M$  is of Heegaard genus two and contains an essential torus. Let  $M = A \cup_P B$  be a (strongly irreducible) genus two Heegaard splitting. Using the sweep-out of  $M$  by  $P$  determined by the Heegaard splitting, we can isotope  $F$  so that it intersects  $A$  and  $B$  in a collection of essential annuli. Indeed, it is easy to arrange that all curves of  $P \setminus F$  are essential in both surfaces, so each component of  $F - P$  is an incompressible annulus (cf [16]). Inessential annuli in  $A$  or  $B$  can be removed by an isotopy. In the end, since no component of  $F$  can lie in a handlebody,  $F \setminus A$  and  $F \setminus B$  are non-empty collections of essential annuli.

Note that if  $T$  is a torus in  $F$  and  $\gamma$  is an essential curve in  $T$ , then on at least one side of  $T$ ,  $\gamma$  cannot be the end of an essential annulus. This is obvious if on one side of  $T$  the component of  $M - T$  is acylindrical. If, on the other hand, both sides are Seifert manifolds, then the annuli must both be vertical, so the berings of the Seifert manifolds agree on  $T$ . This contradicts the minimality of



$F$ . These remarks show that in  $P$ , if  $l(P \setminus F) = (k; l; 0; 0)$  then  $0 \leq l \leq k - 2$  (and of course  $k + l$  is even). With this in mind, we now examine how the tori  $F$  can intersect  $A$  and  $B$ .

Note that most of this section is covered by results in [12]. Our perspective here is somewhat different though, as we are interested in multiple splittings of the same manifold. We include a complete list of cases for future reference in later sections.

**Case 1** (Single annulus) From 5.6 we see that if  $k = 2; l = 0$  then  $F$  is a separating annulus in each of  $A$  and  $B$  and the Seifert manifold  $V \setminus M$  has base space a disk and two singular fibers. Since  $P \setminus V$  is a single annulus, call this the *single annulus* case. Example 4.1, Variation 2 describes all splittings of this type. A special case is 4.4 Variation 3, when one of the Dehn surgery curves is placed in  $\partial_a$  and the other in either  $\partial_b$  or  $\partial_c$ . When one is in  $\partial_a$  and the other in  $\partial_b$ , the annulus  $P \setminus V$  is in the part of  $\partial A \setminus \partial$  that's identified with  $\partial B \setminus \partial$ . See Figure 15.

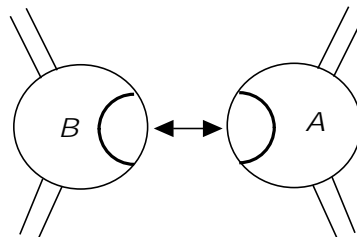

Figure 15

**Case 2** (Non-separating torus) If  $k = l = 1$  then  $F$  intersects both  $A$  and  $B$  in a single non-separating annulus. Since no properly imbedded annulus in  $M - F$  (with ends on the same side of  $F$ ) is essential, the involution  $\rho$  takes each annulus  $F \setminus A$  and  $F \setminus B$  to itself. This means that in each of  $A$  and  $B$  the curves  $F \setminus P$  are longitudes. Call this the *single non-separating torus* case. Example 4.3 describes all splittings of this type. See Figure 16.

The case  $k = l = 2$  admits a number of possibilities, depending on whether the annuli in  $A$  and/or  $B$  are separating or non-separating and, if non-separating, whether they are parallel or not.

**Case 3** (Double torus) If  $k = l = 2$  and annuli on both sides are non-separating, then either  $F$  is a single separating torus, for example cutting off the neighborhood of a one-sided Klein bottle (discussed as Case 7 below), or

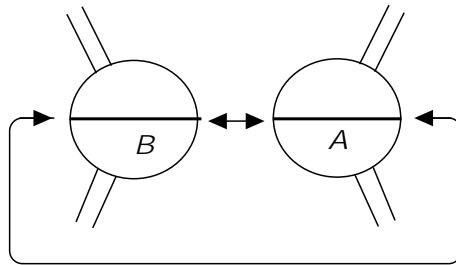

Figure 16

$F$  is a pair of non-separating tori. Between the tori lies a Seifert manifold with base the annulus and one or two singular fibers (at most one in each of  $A$  and  $B$ ). Whether there are one or two singular fibers depends on whether the annuli on one side or both sides are non-parallel. Call the latter the *double torus* case. Example 4.3, Variations 1 and 2 describe all splittings of this type. See Figure 17.

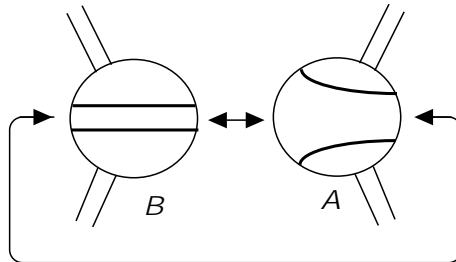

Figure 17

**Case 4** (Double annulus) Suppose  $k = l = 2$  and in one of  $A$  or  $B$ , say  $A$ , the annuli are separating and in the other they are non-separating and non-parallel. Then  $F$  is a single separating torus. On one side of the torus is a Seifert manifold  $V$  fibering over the disk with three exceptional fibers, two in  $A$  and the third in  $B$  lying between the pair of non-separating annuli  $F \setminus B$ . Call this the *double annulus* case. Example 4.4, Variation 4 describes all splittings of this type. See Figure 18. The dotted half-circle indicates schematically that there is an additional twisted annulus, not visible in this cross-section and separated from the visible one by a separating disk in the handlebody.

**Case 5** (Parallel annuli) Suppose  $k = l = 2$  and in one of  $A$  or  $B$ , say  $A$ , the annuli are separating and in the other they are non-separating and parallel.

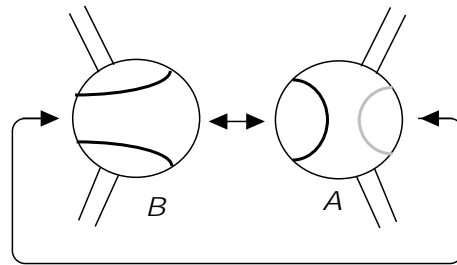

Figure 18

Then again  $F$  is a single separating torus. On one side of the torus is a Seifert manifold  $V$  fibered over the disk with two exceptional fibers, both in  $A$ .  $F \setminus B$  and  $P \setminus V$  are each a pair of parallel annuli, so call it the *parallel annuli* case. Notice that the annuli  $F \setminus B$  are longitudinal by the same argument as in the single non-separating torus case. Example 4.4, Variation 3, with surgeries in  $a_+$  and  $a_-$ , describes all splittings of this type. See Figure 19.

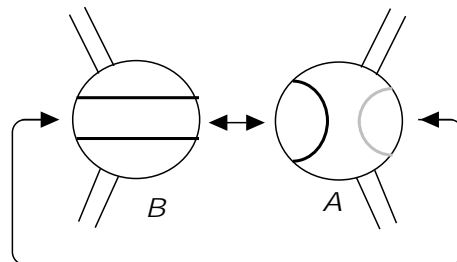

Figure 19

**Case 6** (Non-parallel tori) Suppose  $k = l = 2$  and in both of  $A$  and  $B$  the annuli are separating. Then  $F$  consists of two separating tori, each bounding Seifert manifolds which fiber over the disk with two exceptional fibers. Example 4.2, Variation 1, with Dehn surgery performed on all four of  $na_i, nb_i, sa_i, sb_i$  describes all examples of this type. See Figure 20.

**Case 7** (Klein bottle) If  $k = l = 2$  and annuli on both sides are non-separating, then it could be that, when the pairs of annuli are attached along their ends, the result is a single separating torus. The torus cuts off a Seifert piece  $V$  that is the union of the two parts of  $A$  and  $B$  that lie between the annuli. For example, if the pairs of annuli  $F \setminus A$  and  $F \setminus B$  are both parallel in  $A$  and  $B$  respectively, then  $V$  is the neighborhood of a one-sided Klein bottle.

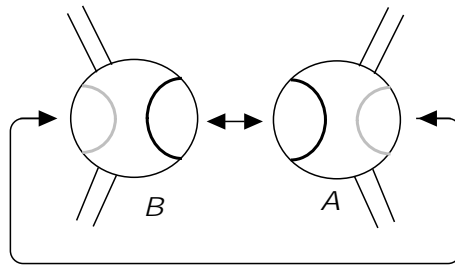

Figure 20

More generally,  $V$  fibers over a Möbius band with zero, one, or two singular fibers (at most one in each of  $A$  and  $B$ ). Note that when there are no singular fibers, so  $V$  is the neighborhood of a one-sided Klein bottle, then  $V$  can also be fibered over the disk with two singular fibers. The fiberings circles are orthogonal in  $@V$ ; in the fibering over the Möbius band the fiber projects to a curve in the Klein bottle whose complement is a cylinder and in the fibering over a disk the fiber projects to a curve whose complement is two Möbius bands. These cases correspond to Example 4.4. See Figure 21.

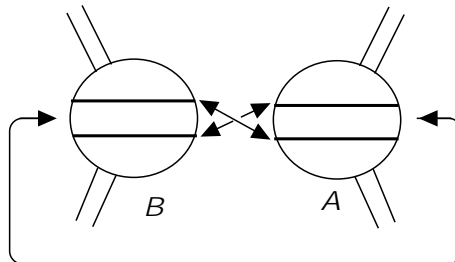

Figure 21

As can be seen from the above descriptions, each case is determined, with one exception, by the Seifert piece  $V$ . If  $V$  is just the neighborhood of a single non-separating torus, this is the non-separating torus case. If  $V$  is a Seifert manifold over the annulus with one or two exceptional fibers then it is the double torus case. If  $V$  has two components (each fibered over the disk with two exceptional fibers) then it is the non-parallel tori case. If  $V$  fibers over the disk with three exceptional fibers then it is the double annulus case. If  $V$  fibers over the Möbius band with one or two exceptional fibers, then it is the Klein bottle case. Only when  $V$  fibers over the disk with two exceptional fibers, could the splitting be either the single annulus or the parallel annuli case or (if both singular fibers have slope  $1=2$ ) the Klein bottle case.

In some situations the splittings described by the single annulus and the parallel annuli case are closely related. For example, begin with Example 4.4 Variation 3, with one Dehn surgery circle in each of  $a_+$ . This is the parallel annuli case, with canonical tori  $a_+ \sqcup a_-$ . Now move the surgery circle in  $a_+$  into  $a_-$ . This is now the single annulus case, with canonical tori  $a_-$ . In fact, if we cut along the annulus  $a_- \setminus \text{core}$ , no longer identifying boundaries of  $A$  and  $B$  there, the result is a splitting as in Example 4.1, Variation 2. See Figure 22.

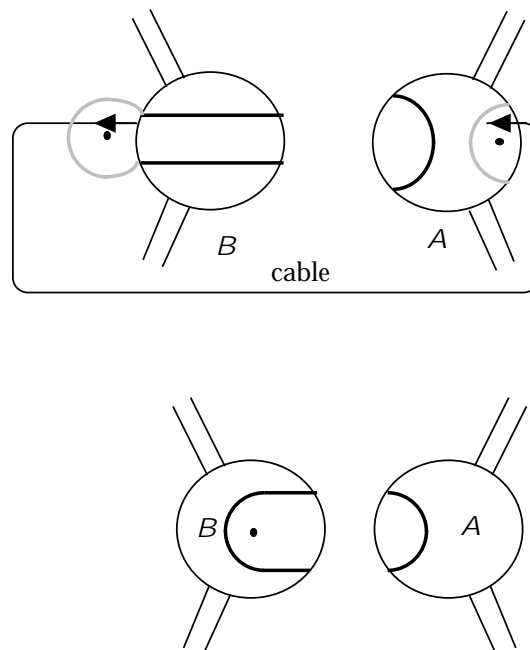

Figure 22

We can formalize this example as follows:

**Lemma 6.1** *Suppose  $M = A \sqcup_P B$  has Seifert part  $V$ , being over the disk with two exceptional fibers. Suppose  $P$  intersects  $V$  as in the parallel annuli case (that is,  $P \setminus V$  consists of two essential parallel annuli) and the region between the annuli lies in  $B$ , say. Then  $P$  can be cabled into  $A$  to get a splitting surface  $P^\theta$  intersecting  $V$  as in the single annulus case. Moreover in  $B^\theta - V$  there is an annulus with one end a core of the annulus  $F \setminus B^\theta$  and other end a curve on  $P^\theta$  which is longitudinal in  $A^\theta$ .*

*Dually, suppose  $P$  intersects  $V$  as in the single annulus case and in  $B - V$  there is an annulus with one end a core of  $F \setminus B$  and other end a curve on*

$P$  which is longitudinal in  $B$ . Then  $P$  can be cabled into  $B$  to get a splitting surface  $P^\theta$  intersecting  $V$  as in the parallel annulus case.

**Proof** The first part is obtained by replacing one of the annuli in  $P \setminus V$  with the incident annulus component of  $F \setminus B$ . The second part follows from the first by reversing the construction.

In the example preceding the lemma, a spanning annulus as called for in the lemma is one in parallel to  $@ \setminus b$ .  $\square$

In each of the seven cases listed above, there is a Seifert part  $V$  (possibly just a thickened torus in the non-separating torus case) which  $P$  intersects in annuli and a single complementary component  $W$  which it intersects in a more complicated surface. Since  $F$  lies in  $V$  we know that  $W$  is atoroidal. It is also acylindrical except possibly for an annulus whose ends in  $@V$  are non-bered curves and whose complement in  $W$  is one or two solid tori. That is,  $W$  could itself be a Seifert manifold over a disk with two exceptional fibers or over an annulus or Möbius band with one exceptional fiber, as long as the bering doesn't match the bering of  $V$ .

In any case,  $W$  has the following structure:  $W = A_- [P_- B_-$ , where  $P_-$  is a properly imbedded surface (either a 4-punctured sphere or, exactly in the single annulus case, a twice punctured torus) and  $A_-; B_-$  are each genus two handlebodies.  $P_-$  lies in  $@A_-$  and  $@B_-$  as the complement of one or two longitudinal curves. In each case where this makes sense (ie, except in the single non-separating torus case),  $@P_-$  is a fiber of the Seifert manifold  $V$  on the other side of  $F$ .  $A_-$  (resp.  $B_-$ ) can be viewed as the mapping cylinders of maps from  $P_-$  to a 2-complex  $A$  (resp.  $B$ ) consisting of one or two annuli in  $F$  and a single arc in  $A_-$  (resp.  $B_-$ ) with ends on the annuli. Hence  $W - (@A_- [ @B_-)$  is a product, restricting to a product structure on the annuli  $@W - (@A_- [ @B_-)$ . (Here  $@$  denotes regular neighborhood.) Hence it can be swept out by  $P_-$ .

This sweep-out gives us some information about what sort of annuli might be present in  $W$ .

**Lemma 6.2** *Suppose  $W$  contains an essential annulus with neither end parallel to  $@P_-$ . Then  $W$  contains an essential annulus or one-sided Möbius band which intersects  $P_-$  precisely in two parallel spanning arcs.*

**Proof** Consider how  $P_-$  intersects the annulus  $A$  during the sweep-out of  $W$ . At the beginning it inevitably intersects  $A$  in  $@$ -compressing disks lying in

$A_-$ . At the end it intersects  $A$  in  $\partial\{$ compressing disks lying in  $B_-$ . Nowhere can it intersect it in both, so somewhere it intersects it in neither. (The details are standard and are suppressed.) This means that the intersection of  $P_-$  with  $A$  consists entirely of spanning arcs of  $A$ . The squares into which  $A$  are cut by these arcs lie alternately in  $A_-$  and  $B_-$ . It's easy to see that all these arcs are parallel in  $P_-$  so, we can assemble two of the squares into which  $A$  is cut, one in  $A$  and one in  $B$ , to produce an annulus or one-sided Möbius band which intersects  $P_-$  precisely in two arcs.  $\square$

Let  $A$  be the annulus or one-sided Möbius band given by the preceding lemma 6.2 and let  $R_A; R_B$  be the squares in which  $A$  intersects  $A_-$  and  $B_-$  respectively. The complement of  $A$  in  $W$  is one or two solid tori, depending on whether  $A \cap W$  is separating or not. Moreover the complement of  $R_A$  in  $A_-$  is also one or two solid tori depending on whether  $R_A \cap A_-$  is separating or not, and similarly for  $B_-$ . Similarly  $P_- - A$  is one or two annuli. Since these annuli divide each solid torus of  $W - A$  into two solid tori, they are longitudinal annuli in the solid torus. These facts give useful information about, for example, the index of the singular fibers, but the crucial point here is that the description is now sufficiently detailed that we have explicitly:

**Proposition 6.3** *Suppose  $W$  contains an essential spanning annulus with neither end parallel to  $\partial P_-$ . Suppose the annulus is unique up to proper isotopy and  $A$  is the annulus or one-sided Möbius band given by Lemma 6.2. Then there is an  $A$ -preserving involution  $\tau_W$  of  $W$ , defined independently of  $P$  and a proper isotopy of  $P_-$  in  $W$  so that after the isotopy  $\tau_W j P_- = j P_-$ .*

**Proof** The proof is left as an exercise. The fixed point set of  $\tau_W$  intersects  $A$  either

- in two points, the centers of each of  $R_A$  and  $R_B$  or
- in two proper arcs orthogonal to the core of  $A$  or
- in the core of  $A$ ,

depending on the structure of  $W$ .  $\square$

Proposition 6.3 is phrased to require a possible isotopy of  $P_-$  rather than of  $A$ , since in its application we will be isotoping two different Heegaard splittings, using  $A$  as a reference annulus. Also, the proper isotopy of  $P_-$  in  $W$  is not necessarily fixed on  $\partial P_-$ , so in fact  $\tau_P$  should be regarded as  $\tau_W$  composed with some Dehn twist along a component (or two) of  $\partial W$ .

## 7 Longitudes in genus 2 handlebodies | some technical lemmas

We will need some technical lemmas which detect and place longitudes in a genus two handlebody.

**Definition 7.1** Two curves  $c_1, c_2 \subset \partial H$  on a genus two handlebody  $H$  are *separated* if they lie on opposite sides of a separating disk in  $H$ . Two curves  $c_1, c_2 \subset \partial H$  are *coannular* if they constitute the boundary of a properly imbedded annulus in  $H$ .

**Lemma 7.2** *Suppose  $H$  is a genus two handlebody and the disjoint curves  $c_1, c_2, c_3 \subset \partial H$  divide  $\partial H$  into two pairs of pants. Suppose that  $c_1, c_2 \subset \partial H$  are nonmeridinal curves which are coannular in  $H$ . Then  $c_3$  is either meridinal or it intersects every meridian disk.*

**Proof** Suppose there were a meridian disk  $D$  disjoint from  $c_3$  and consider how  $D$  intersects the annulus  $A \subset H$  whose boundary is  $c_1 \cup c_2$ . Assume  $jD \setminus Aj$  has been minimized. If  $D \setminus A = \emptyset$ ; then  $D$  is a separating disk in the handlebody  $H^\partial = H - (A)$ . Then  $\partial D$  divides  $\partial H - \partial A$  into two pairs of pants, so any essential curve in the complement of  $\partial D \cup \partial A$ , eg  $c_3$  is parallel either to  $\partial D$  or a component of  $\partial A$ . But the latter violates the hypothesis.

If  $D \setminus A \neq \emptyset$ ; then consider an outermost arc of intersection in  $D$ . It cuts off a meridian disk  $E$  of  $H^\partial$  that is disjoint from  $c_3$ . Two copies of  $E$  banded together along the core of  $A$  in  $\partial H^\partial$  gives a separating disk disjoint from  $c_3$ . This reduces the proof to the previous case.  $\square$

**Lemma 7.3** *Suppose  $H$  is a genus two handlebody and the disjoint curves  $c_1, c_2, c_3 \subset \partial H$  divide  $\partial H$  into two pairs of pants. Suppose that  $c_1, c_2 \subset \partial H$  are nonmeridinal curves which are coannular in  $H$ . Let  $A$  be an annulus, with ends denoted  $\partial_+ A$ , and attach  $A$  to  $H$  by identifying  $\partial_+ A$  to a collar of  $c_2$  and  $\partial_- A$  to a collar of  $c_3$ . Then the resulting manifold  $H^\partial$  is not a genus two handlebody.*

**Proof** If  $H^\partial$  were a genus two handlebody, then the dual annulus  $A^\partial = (\text{core}(A) \cup \partial_+ A) \cup (\text{core}(A) \cup \partial_- A)$  would be a non-separating annulus in  $H^\partial$ . This means that in the handlebody ( $H$  again) obtained by cutting open along  $A^\partial$ , both  $c_2$  and  $c_3$  would be twisted or longitudinal, but in any case each would be disjoint from some meridian disk. But in the case of  $c_3$  this would violate Lemma 7.2.  $\square$



**Lemma 7.4** *Suppose  $H$  is a genus two handlebody and the disjoint curves  $c_1, c_2, c_3 \subset \partial H$  are nonmeridional curves that divide  $\partial H$  into two pairs of pants,  $V$  and  $V^0$ , with  $\partial V = \partial V^0 = c_1 \cup c_2 \cup c_3$ . Suppose that  $c_1, c_3 \subset \partial H$  are separated curves and that  $c_2$  is disjoint from some meridian disk. Then one of  $c_1$  or  $c_3$  is a longitude, and there is a disk  $D$  which separates  $c_1$  and  $c_3$  so that  $j \cap D \setminus c_2 = 2$ .*

*In particular, if both  $c_1$  and  $c_3$  are longitudes, then  $H = V \cup V^0$ .*

**Proof** Let  $\mathcal{D}$  be the union of three disjoint disks: a disk  $D$  that separates  $c_1$  and  $c_3$ , and disjoint meridian disks  $D_1$  and  $D_3$  which intersect  $c_1$  and  $c_3$  respectively. Choose this collection and a meridian disk  $D_2 \subset H$  whose boundary is disjoint from  $c_2$ , so that, among all such disk collections,  $j \cap \mathcal{D}$  is minimal. We can assume that  $c_2$  intersects each disk of  $\mathcal{D}$ , since  $c_2$  is not parallel to either  $c_1$  or  $c_3$ . Hence  $D_2$  is not parallel to any disk in  $\mathcal{D}$ , so in fact  $j \cap D_2 \neq \emptyset$ .

By minimality of  $j \cap \mathcal{D}$  all components of intersection are proper arcs in  $\mathcal{D}$ . Consider an arc  $\alpha$  of  $j \cap D_2$  which is outermost in  $D_2$ . Simple counting arguments show that  $\alpha \cap D$ , that the subdisk of  $D_2$  cut off by  $\alpha$  intersects  $c_1$  or  $c_3$  (say  $c_1$ ) in a single point (for the arc is disjoint from  $c_2$ ). In particular,  $c_1$  is a longitude. Even more, it follows then that as many points of intersection with  $c_2$  lie on one side of  $\alpha$  in  $D$  as on the other. Since this is true for any outermost arc, it follows that all outermost arcs of  $j \cap D_2$  in  $D_2$  are parallel to  $\alpha$  in  $D - c_2$ . Furthermore we may as well assume that all outermost disks of  $D_2$  cut off by these arcs lie on the same side of  $D$ , the side containing  $c_1$ , since otherwise two could be assembled to give a third meridian disk  $D_4$  which would be disjoint from the disks  $D_1, D_3$  and from the longitude  $c_2$  and which would intersect  $c_1$  and  $c_3$  exactly once. The proof would then follow immediately. (See Figure 23.)

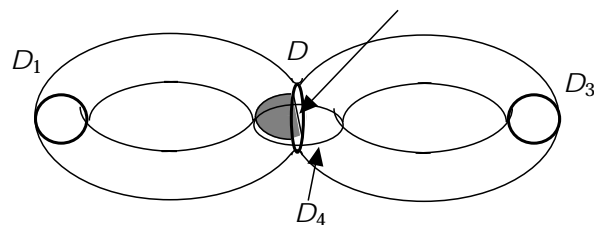

Figure 23

Now consider a disk component  $E$  of  $D_2 - \text{---}$  which is "second to outermost". That is, all but at most one arc of  $@E - @H$  is an outermost arc of intersection with  $\text{---}$  in  $D_2$ . To put it another way,  $@E$  is a  $2n$ -gon, where every other side lies in  $@H$ , and of the  $n$  remaining sides, at least  $n - 1$  are parallel to  $\text{---}$  in  $D$ . The last side  $s_n$  is perhaps an arc of  $\text{---} \setminus D_2$ . (See Figure 24.)

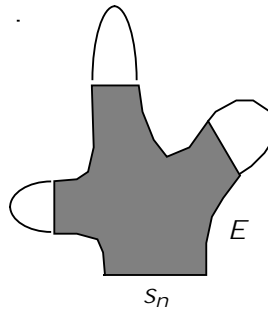

Figure 24

The sides of  $E$  that lie in  $@H$  and that have both ends on  $@$  are easy to describe: Since they are disjoint from  $D_3$  and are essential in the pair of pants component of  $@H - @$  on which they lie, each must cross  $c_3$ . Moreover, since they are disjoint from  $c_2$ , they can't cross  $c_3$  more than once, hence they cross  $c_3$  exactly once. Moreover, each must have its ends at opposite ends of  $\text{---}$ , since if any had both ends at the same end of  $\text{---}$  it would follow that  $c_2 \setminus D_3 = \text{---}$ ; and that would force  $c_2$  to be parallel to  $c_1$ . But even one such arc of  $@E \setminus @H$ , disjoint from  $c_2$  and  $D_3$ , crossing  $c_3$  once and having ends at opposite ends of  $\text{---}$ , could be combined with an outermost disk of  $D_2$  with side at  $\text{---}$  to give a meridian disk  $D_4$  as described before.

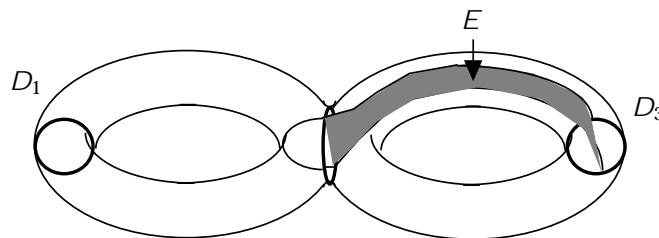

Figure 25

So the only remaining case to consider is  $n = 2$ , with  $s_n$  not parallel to  $\text{---}$  in  $D$ . So  $E$  is a square, with one side parallel to  $\text{---}$  and the opposite side,  $s_2$ , an arc

lying in  $D_3$  or  $D$ . (See Figure 25.) Then simple combinatorial arguments in the pair of pants bounded by  $D$  and  $D_3$  show that  $s_2 \cap D_3$ , since otherwise  $s_2$  and  $s_3$  would cross in  $D$ . With  $s_2 \cap D_3$ , a simple counting argument shows that  $s_2$  cuts off from  $D_3$  a disk which can be made disjoint from  $c_3$  and intersecting  $c_2$  in a single point. The union of this disk and  $E$  along  $s_2$  gives a disk, parallel to a subdisk of  $D$  cut off by  $s_2$  that is disjoint from  $c_1$  and  $c_3$  and intersects  $c_2$  exactly once. It follows that  $D$  intersects  $c_2$  twice, as required.  $\square$

**Lemma 7.5** *Suppose  $H$  is a genus two handlebody and the curves  $c_1; c_2; c_3 \in \partial H$  divide  $\partial H$  into two pairs of pants,  $V$  and  $V^\theta$  with  $\partial V = \partial V^\theta = c_1 \cup c_2 \cup c_3$ . Suppose that  $c_1; c_3 \in \partial H$  are separated non-meridinal curves and there is a properly imbedded disk in  $H$  which intersects  $c_1 \cup c_2$  in a single point. Then  $c_3$  is a longitude, and there is a disk  $D$  which separates  $c_1$  and  $c_3$  so that  $j \cap D \setminus c_2 j = 2$ .*

*In particular, if  $c_1$  is also a longitude, then  $H = V \cup I$ .*

**Proof** Suppose there is a disk  $D^\theta$  that is disjoint from  $c_1$  and intersects  $c_2$  in a single point. Then  $c_2$  is a longitude and it follows from Lemma 7.4 that some disk  $D$  separating  $c_1$  from  $c_3$  intersects  $c_2$  twice. Using outermost arcs of intersection in  $D$ , it's then easy to modify the disk  $D^\theta$  so that it is disjoint from  $D$ . Then  $D^\theta$  must be a meridian curve for the solid torus on the side of  $D$  that contains  $c_3$ . Since  $D^\theta$  intersects  $c_2$  in one point, it follows that it also intersects  $c_3$  in one point, completing the proof in this case.

Suppose there is a disk  $D^\theta$  that is disjoint from  $c_2$  but intersects  $c_1$  in one point (so, in fact,  $c_1$  is a longitude). By Lemma 7.4 there is a disk  $D$  that separates  $c_1$  and  $c_3$  and intersects  $c_2$  twice. Choose the pair of disks  $D$  and  $D^\theta$  so that, among all such disks,  $j \cap D \setminus D^\theta j$  is minimal.

Consider an outermost disk  $E$  cut off by  $D$  in  $D^\theta$ , so  $E$  is disjoint from both  $c_1$  and  $c_2$ . Then  $E$  lies on the side of  $D$  containing  $c_3$  (since it is disjoint from  $c_1$ ) and must intersect  $c_3$  at most (hence exactly) once, since it is disjoint from  $c_2$ . Thus  $c_3$  is also a longitude.  $\square$

**Corollary 7.6** *Suppose  $H$  is a genus two handlebody and the curves  $c_1; c_2; c_3 \in \partial H$  divide  $\partial H$  into two pairs of pants,  $V$  and  $V^\theta$  with  $\partial V = \partial V^\theta = c_1 \cup c_2 \cup c_3$ . Suppose that  $c_1; c_3 \in \partial H$  are separated curves. Let  $A$  be an annulus with ends  $\partial A$ . Attach  $A \cup I$  to  $H$  by identifying  $\partial_+ A \cup I$  to a collar of  $c_1$  and  $\partial_- A \cup I$  to a collar of  $c_2$ . Suppose the resulting manifold is also a genus two handlebody. Then  $c_3$  is a longitude of  $H$ , and there is a disk  $D \subset H$  which separates  $c_1$  and  $c_3$  in  $H$  and which intersects  $c_2$  exactly twice. Moreover, if  $c_1$  is also a longitude of  $H$ , then  $H = V \cup I$ .*

**Proof** Let  $H^0$  be the new handlebody, and consider the properly imbedded dual annulus  $core(A) \cap H^0$ . Since it's  $\partial$ -compressible in  $H^0$ , it follows that there is a disk  $D^0$  in  $H$  which intersects  $c_1 \cup c_2$  in a single point. The result follows from the previous lemma.  $\square$

**Corollary 7.7** *Lemma 7.6 remains true if  $A \cap I$  is replaced by any solid torus  $S^1 \times D^2$ , attached at  $c_1$  and  $c_2$  along parallel, essential, non-meridional annuli in  $\partial(S^1 \times D^2)$ .*

The proof is the same, using either attaching annulus at  $c_1$  or  $c_2$  in place of  $core(A) \cap I$ .  $\square$

## 8 Positioning a pair of splittings | the hyperbolike case

A closed, orientable, irreducible 3-manifold  $M$  is called *hyperbolike* if it has finite fundamental group and contains no immersed essential torus. In the next two sections we will show that any two Heegaard splittings of the same hyperbolike 3-manifold can be described by some variation of one of the examples in Section 4. As a consequence, the standard involutions of the manifold induced by the two splittings commute.

In this section we will isotope the splitting surfaces  $P$  and  $Q$  so that they are transverse and so that the curves of intersection and the pieces of the surfaces cut out by them are particularly informative. In the next section, we will move the surfaces so that they are no longer transverse, but rather coincide as completely as possible.

Especially in the latter context, it will be useful to be able to refer easily to the pieces of one splitting surface that lie in the interior of one of the other handlebodies.

**Definition 8.1** Suppose  $M = A \cup_P B = X \cup_Q Y$  are two Heegaard splittings of  $M$ . Let  $P_X$  denote the closure of  $P \setminus (interior X)$ . (So if  $P$  and  $Q$  are transverse, as will not often be true in later discussion, then  $P_X$  is just  $P \setminus X$ .) Similarly define  $P_Y$ ,  $Q_A$  and  $Q_B$ .

We begin with a useful lemma.

**Lemma 8.2** Suppose  $X [{}_Q Y$  is a genus two Heegaard splitting of a closed hyperbolike manifold  $M$  and  $D_X, D_Y$  are essential properly imbedded disks in  $X$  and  $Y$  respectively. Then  $j@D_X \setminus @D_Y j = 3$ .

**Proof** If  $jD_X \setminus D_Y j = 1$  then  $X [{}_Q Y$  is stabilized and so  $M$  is either a lens space, or  $S^2 \times S^1$  or  $S^3$ , but in any case is not hyperbolike. Suppose  $jD_X \setminus D_Y j = 0$  (so  $X [{}_Q Y$  is *weakly reducible*). If the boundaries of  $D_X$  and  $D_Y$  are parallel in  $Q$ , or one of the boundaries is separating, then  $X [{}_Q Y$  is reducible. This means that either  $M$  is reducible (hence not hyperbolike) or  $X [{}_Q Y$  is stabilized, and we have just shown that this is impossible. If the boundaries of  $D_X$  and  $D_Y$  are non-separating and non-parallel then the surface  $S$  obtained from  $Q$  by doing both compressions simultaneously is a sphere. Moreover  $S$  contains a separating essential circle of  $Q$  which is compressible on both sides, so again  $X [{}_Q Y$  is reducible.

Finally, suppose  $jD_X \setminus D_Y j = 2$ . Then the union of collar neighborhoods  $(D_X)$  and  $(D_Y)$  of  $D_X$  and  $D_Y$  along their two squares of intersection is a solid torus  $W$ . Denote by  $X_-$  (resp.  $Y_-$ ) the solid torus or pair of tori obtained by compressing  $X$  along  $D_X$  (resp.  $Y$  along  $D_Y$ ). Then  $M$  is the union of  $X_-; Y_-$  and  $W$ , and the annuli of attachment of  $W$  to  $X_-$  and  $Y_-$  are either longitudinal (if the two points of intersection of  $@D_X$  and  $@D_Y$  have opposite orientation) or of slope  $(1;2)$  in  $W$  (if the two points of intersection of  $@D_X$  and  $@D_Y$  have the same orientation).

So  $M$  is the union of solid tori along essential annuli in their boundary. It is therefore either reducible or a Seifert manifold. In any case it is not hyperbolike.  $\square$

Suppose  $X [{}_Q Y$  and  $A [{}_P B$  are two genus two Heegaard splitting of a closed hyperbolike manifold  $M$ . The two splittings define generic sweep-outs of  $M$ , as described in [16]. The pair of sweep-outs is parameterized by points in  $I \times I$ . Points in  $I \times I$  corresponding to positions where  $P$  and  $Q$  are not transverse constitute a subcomplex of  $I \times I$  called the *graphic*. Complementary components are called *regions*.

Since the surfaces involved have low genus, we can obtain useful information about their relative positioning even if we allow a more liberal rule than in [16] for labelling regions (that is, positionings in which  $P$  and  $Q$  are transverse). We label a region  $A$  (resp.  $B$ ) if there is a meridian disk  $D$  for  $A$  (resp.  $B$ ) such that  $@D = (P - Q)$ . Labels  $A$  and  $B$  will be called  $P$ {labels}. Similarly, we label a region  $X$  (resp.  $Y$ ) if there is a meridian disk for  $X$  (resp.  $Y$ ) whose boundary is disjoint from  $P$ . These labels are called  $Q$ {labels}.

Suppose that  $C$  is the collection of curves of  $P \setminus Q$  that are essential in  $P$  (resp.  $Q$ ). Then  $C$  divides  $P$  (resp.  $Q$ ) into two parts, one lying (except for some inessential parts) in  $X$  and one in  $Y$  (resp.  $A$  and  $B$ ). If the two parts of  $P$  (resp.  $Q$ ) have even Euler characteristic we say that the positioning is  $P$  {even (resp.  $Q$  {even). If the two have odd Euler characteristic we say it's  $P$  {odd (resp.  $Q$  {odd).

**Lemma 8.3** *If a region is  $P$  {odd then its  $P$  {labels are a subset of the  $P$  {labels of any adjacent region. Similarly for  $Q$  {odd regions and  $Q$  {labels.*

**Proof** By construction, we are ignoring curves in  $P \setminus Q$  which are inessential in  $P$ , so no component of  $P - C$  is a disk. If the region is  $P$  {odd, then it follows that both parts have Euler characteristic  $-1$ . This implies that, if there is a meridian for  $A$  disjoint from  $Q$  then in fact some curve in  $C$  is a meridian of  $A$ . Since  $C$  can be pushed into  $P_X$  or  $P_Y$ , this means that both  $P_X$  and  $P_Y$  contain a meridian of  $A$ .

The effect of moving to an adjacent region in the complement of the graphic is to alter  $P_X$  and  $P_Y$  by adding a band (or a disk) to one and removing it from the other. Clearly adding a band (or disk) doesn't destroy a curve, such as the meridian, so one copy of the meridian of  $A$  persists in at least one of  $P_X$  or  $P_Y$  in the new region.  $\square$

**Lemma 8.4** *If there are adjacent regions which are both  $P$  {even (resp.  $Q$  {even) then the  $P$  {labels (resp.  $Q$  {labels) of one are a subset of the  $P$  {labels (resp.  $Q$  {labels) of the other. If there are adjacent regions which are each both  $P$  {even and  $Q$  {even then the set of all labels for one of the regions is a subset of the labels for the other.*

**Proof** Suppose two adjacent regions are both  $P$  {even. Moving from one region to the other may represent moving across a center tangency, which clearly has no effect on labels, or moving across a saddle tangency. The latter changes the Euler characteristic of  $P_X$  and  $P_Y$  by  $\pm 1$ , so if the parity determined by  $C$  doesn't change, the saddle move must have created or destroyed an inessential curve of  $P \setminus Q$ . This means that one or both ends of the band that is exchanged from  $P_X$  to  $P_Y$  or vice versa, lies on an inessential curve of  $P$ . If one end lies on an inessential curve, then the move is effectively an isotopy of  $C$  and so has no effect on the labelling. If both ends lie on the same inessential curve the effect is to add two parallel, possibly essential, curves to  $C$ . This won't add a label  $A$  or  $B$ , since a meridian lying in the annulus created in  $P_Y$  previously

lay in  $P_X$ , but it might destroy some other meridian in  $P_X$ , so a label might be deleted. This is the only way in which  $A$  and  $B$  labels could change. To summarize: if there is a change in  $A$  or  $B$  label it's to delete a label moving from the first region to the second, and this only happens if the corresponding band has both ends on the same curve of  $P \setminus Q$ , and that curve is inessential in  $P$ .

Now consider the situation in  $Q$  if the adjacent regions are also both  $Q$ {even. Moving from the second region to the first we have already seen that the band that's attached will have its ends on two different curves (the two created in moving from the first to the second region). So no  $X$  or  $Y$  label can disappear. It follows that the set of labels for the second region is a subset of the set of labels for the first region.  $\square$

**Lemma 8.5** *Any region that is  $P$ {even and  $Q$ {odd (or vice versa) has a label that is also a label of every adjacent region.*

**Proof** It's easy to see that  $(P_X)$  and  $(Q_A)$  have the same parity: For example, the sum of their parities is the parity of the orientable surface created by doing a double-curve sum of the two surfaces. Furthermore, removing curves of  $P \setminus Q$  that are inessential in both  $P$  and  $Q$  does not alter the parity match. So if a region is  $P$ {even and  $Q$ {odd it follows that at least one curve in  $P \setminus Q$  is essential in  $P$  and inessential in  $Q$  (or vice versa), ie, is a meridian of  $A$  or  $B$  (or  $X$  or  $Y$ ). When passing to an adjacent region in the complement of the graphic, a band is added to either  $P_X$  or  $P_Y$ , say the former. Before passing to the new region, move slightly into  $P_X$ . Then will still lie in  $P_X$  after moving to the adjacent region.  $\square$

**Lemma 8.6** *If two adjacent regions have labels  $A$  and  $B$  then one of them has both labels  $A$  and  $B$ .*

**Proof** This follows from 8.3 if either region is  $P$ {odd and from 8.4 if both regions are  $P$ {even.  $\square$

**Lemma 8.7** *No region has both labels  $A$  and  $B$ .*

**Proof** The proof is a recapitulation of ideas in [16] and [10].

Suppose a region has both labels. The meridians are unaffected by removing, by an isotopy, all simple closed curves in  $P \setminus Q$  which are inessential in both  $P$  and  $Q$ . The meridians of  $A$  and  $B$  which account for the labels must intersect,

by 8.2, so they cannot be on opposite sides of  $Q$ . If any curve of  $P \setminus Q$  is essential in  $P$  and inessential in  $Q$  then it is a meridian of  $A$ , say, that can be pushed to lie on the opposite side of  $Q$  from the meridian of  $B$ , a contradiction. So every curve in  $P \setminus Q$  is essential in  $Q$ .

Say the meridians of  $A$  and  $B$  that are disjoint from  $Q$  both lie in  $X$ . If any component of  $P_X$  is a  $\partial$ -parallel annulus, push it across into  $Y$  | this has no effect on the labelling. If possible,  $\partial$ -reduce  $X$  in the complement of  $P_X$ . We will assume that no such  $\partial$ -reductions are possible, so  $X$  remains a genus two handlebody | the argument is easier if  $\partial$ -reductions can be done. This guarantees that no component of  $P_X$  is a meridian disk of  $X$  so every curve in  $P \setminus Q$  is also essential in  $P$ .

Then the boundary of any meridian disk of  $X$  must intersect  $\partial P$ , since  $P$  is strongly irreducible (8.2). In particular, no curve of  $P \setminus Q$  is a meridian curve for  $X$ , nor can  $P$  lie entirely inside of  $X$ .

Since  $P_X$  is compressible yet no boundary component is a meridian of  $X$  it follows that  $\chi(P_X) = -2$  and a compression of  $P_X$  creates a set of incompressible annuli. Since all curves of  $P \setminus Q$  are essential in both surfaces, one of  $Q_A$  or  $Q_B$ , say the former, has  $\chi(Q_A) = -2$ . Let  $A$  be the incompressible annuli in  $X$  obtained by compressing  $P_X$  into  $A$ . Dually,  $P_X$  is obtained from  $A$  by attaching a tube along an arc dual to the compression disk. It follows from [10, Theorem 2.1] that there is a meridian disk  $D^j$  for  $X$ , isotoped to minimize  $jD^j \setminus A_j$ , so that the arc lies in  $D^j$ .

Consider how a distant meridian disk  $D$  of  $X$  intersects  $A$  and how it intersects a compressing disk  $E$  for  $B$ . First consider an outermost arc of  $A \setminus D$ . Suppose  $\partial E$  is disjoint from (as we can assume is true if the disk cut off by in  $D$  lies in  $B$ ).  $\partial$ -compress  $A$  to  $Q$  via the disk cut off by . This changes an annulus of  $A$  to a disk . If the tube along were attached to it would violate strong irreducibility of  $P$  (since  $\partial$  is a meridian disk for  $A$  disjoint from  $E$ ), so  $P_X$ . If is not  $\partial$ -parallel it is parallel to a meridian disk for  $X$  disjoint from  $P$  and if it is  $\partial$ -parallel then the original annulus was a  $\partial$ -parallel annulus in  $P_X$ . Either is a contradiction. So we can assume that each outermost arc of  $A$  in  $D$  intersects  $\partial E$  and that the disk in  $D$  cut off by the outermost arc lies in  $A$ .

This means that there is a disk in  $B \setminus D$  all but at most one of whose boundary arcs in  $A$  are outermost arcs, and each of these intersects  $\partial E$ . It is now easy to argue (see [10] for details) that in fact is isotopic in  $B \setminus X$  to an arc of  $E \setminus D$  which connects two adjacent outermost arcs, ie, is parallel in  $B \setminus X$  to a spanning arc of one of the annuli of  $Q_B$ . But this implies that there is a



meridian disk for  $B$  (the complement of the tube  $(\ )$  in the annulus of  $Q_B$  of which  $(\ )$  has been made a spanning arc) that intersects the compressing disk for  $A$  dual to  $(\ )$  in two points. This contradicts 8.2.  $\square$

**Lemma 8.8** *There is an unlabelled region.*

**Proof** The argument is a variant of that in [16]. Combining Lemmas 8.6 and 8.7 we see that adjacent regions can't have labels  $A$  and  $B$  or labels  $X$  and  $Y$ . So either there is an unlabelled region or there is a vertex whose four adjacent regions are each labelled with one label, appearing in order around the vertex  $A, X, B, Y$ . Then no region is  $P$ {odd and  $Q$ {even or vice versa, by Lemma 8.5. By Lemma 8.3 the regions labelled  $A$  and  $B$  must be  $P$ {even and those labelled  $X$  and  $Y$  must be  $Q$ {even, so in fact all must be both  $P$ {even and  $Q$ {even. But this would contradict Lemma 8.4.  $\square$

**Theorem 8.9** *Suppose  $X [{}_Q Y$  and  $A [{}_P B$  are two genus two Heegaard splittings of a closed hyperbolic manifold  $M$ . Then  $P$  and  $Q$  can be isotoped in  $M$  so that each curve in  $P \setminus Q$  is essential in both  $P$  and  $Q$ , so that  $(P_X) = (P_Y) = (Q_A) = (Q_B) = -1$  and so that  $P_X$  (resp.  $P_Y, Q_A, Q_B$ ) is incompressible in  $X$  (resp.  $Y, A, B$ ).*

**Proof** Consider the positioning of  $P$  and  $Q$  represented by an unlabelled region. Curves of intersection that are inessential in both surfaces can be removed by an isotopy without introducing meridians in  $P_X, P_Y, Q_A,$  or  $Q_B$ , ie, without altering the fact that the con guration is unlabelled. Then all curves of intersection must be essential in both surfaces, for otherwise at least one such curve would be a meridian. If the con guration is  $P$ {odd (hence also  $Q$ {odd) then we are done.

So suppose the con guration is  $P$ {even (hence  $Q$ {even). With no loss of generality, assume  $(P_X) = (Q_A) = -2$ . Since  $X$  is a handlebody and the region is unlabelled,  $P_X$  is @{compressible. Do a @{compression. If the boundary compression is on an annulus component  $A_P$  of  $P_X$  then the result is a disk. It can't be a meridian disk for  $X$ , by assumption, so  $A_P$  must be @{parallel in  $X$ . Push  $A_P$  across the annulus  $A_Q$  to which it is parallel in  $Q$ . Clearly this does not create a meridian in either  $P_X$  (only an annulus has been removed) or in  $P_Y$  (an annulus has been attached to other annuli). Similarly, if  $A_Q \subset Q_A$  no meridian is created in  $Q_A$  or  $Q_B$ .

Suppose  $A_Q \subset Q_B$ . Then after the annuli are pushed across each other,  $Q_A$  is enlarged, so one might expect that it could contain a meridian curve. But note

that if the meridian disk lay in  $X$  then, after compressing along it one would get a solid torus or two, in which  $P_X$  is incompressible. But this is impossible since  $\chi(P_X) = -2$ . Alternatively, if the meridian disk lay in  $Y$  then note that before the annulus is pushed across, the meridian curve intersects only one end of each of the annuli in  $P_Y$  which have ends on the ends of  $A_Q$ . But in this case, an easy outermost argument shows that there is a meridian curve in  $Q_A$  before the annulus is pushed across, another contradiction. So we conclude that nothing is lost by pushing such boundary parallel annuli in  $P_X$  across  $Q$ .

Eventually, after these parallel annuli are removed,  $P_X$  is  $\partial$ -compressible along an arc lying in a non-annular component of  $P_X$ . The component of  $Q_A$  or  $Q_B$  to which  $P_X$  can be  $\partial$ -compressed is not an annulus, since  $P_X$  contains no meridian curves of  $P$ . Do the  $\partial$ -compression. The result is a positioning of  $P$  and  $Q$  which is both  $P$ -odd and  $Q$ -odd and, essentially by 8.3, it remains unlabelled. This configuration is as required.  $\square$

## 9 Alignment of $P$ and $Q$

**Lemma 9.1** *Suppose  $X \sqcup_Q Y$  and  $A \sqcup_P B$  are two genus two Heegaard splittings of a closed manifold  $M$ , the surfaces  $P_X, P_Y, Q_A$ , and  $Q_B$  are incompressible in, respectively  $X, Y, A$ , and  $B$ . Then the surface  $P_X$   $\partial$ -compresses to one of  $Q_A$  or  $Q_B$ , and  $P_Y$   $\partial$ -compresses to the other.*

**Proof** Each surface  $\partial$ -compresses in the handlebody in which it lies. With no loss of generality assume that  $P_X$   $\partial$ -compresses to  $Q_A$ . Suppose it also  $\partial$ -compresses to  $Q_B$ . Then since  $P_Y$   $\partial$ -compresses to one of  $Q_A$  or  $Q_B$ , we are done. If  $P_X$  fails to  $\partial$ -compress to  $Q_B$  then, symmetrically,  $Q_B$  fails to  $\partial$ -compress to  $P_X$ , so it must  $\partial$ -compress to  $P_Y$ . Hence  $P_Y$   $\partial$ -compresses to  $Q_B$ .  $\square$

**Definition 9.2** Suppose  $P$  and  $Q$  are closed surfaces in a 3-manifold  $M$  and  $P$  (resp.  $Q$ ) is the union of two subsurfaces  $P_0$  and  $P_+$  (resp.  $Q_0$  and  $Q_+$ ) along their common boundary curves. (That is,  $P = P_0 \sqcup_{\partial} P_+$  and similarly for  $Q$ ). Suppose finally that  $P_0 = Q_0$  whereas  $P_+$  and  $Q_+$  are transverse. Then we say that  $P$  and  $Q$  are *aligned along  $P_0 = Q_0$* .

**Lemma 9.3** *Suppose  $M = A \sqcup_P B = X \sqcup_Q Y$  are two genus two Heegaard splittings of a hyperbolic closed 3-manifold. Then the surfaces  $P$  and  $Q$  can be aligned along a subsurface  $P_0 = Q_0$  with  $\chi(P_0) = -2$  in such a way that each component of  $\partial P_0 = \partial Q_0$  is essential in all four handlebodies  $A; B; X; Y$ .*

**Proof** Following Theorem 8.9, isotope  $P$  and  $Q$  so that each curve in  $P \setminus Q$  is essential in both  $P$  and  $Q$ , so that  $\chi(P_X) = \chi(P_Y) = \chi(Q_A) = \chi(Q_B) = -1$  and so that  $P_X$  (resp.  $P_Y, Q_A, Q_B$ ) is incompressible in  $X$ , (resp.  $Y, A, B$ ). (Since  $\chi(P_X) = -1$ , the last condition is equivalent to saying that each curve in  $@P_X$  is essential in  $X$ .) If an annulus component of  $P_X$ , say, is parallel to an annulus component of  $Q_A$ , say, then one can be pushed across the other without affecting these hypotheses. So we can assume that no component of any surface  $P_X, P_Y, Q_A$ , and  $Q_B$  is a  $@\{parallel$  annulus in the handlebody in which it lies. Then, moreover, any  $@\{compression$  of  $P_X$ , if it  $@\{compresses$  an annulus of  $P_X$ , would create a compressing disk for either  $Q_A$  or  $Q_B$ , contradicting the hypothesis. So we can assume that any  $@\{compression$  of any surface is on the unique component whose Euler characteristic is  $-1$ .

Now apply Lemma 9.1 to find a disk  $D_{a,x}$  that  $@\{compresses$   $P_X$  to one of  $Q_A$  or  $Q_B$ , say  $Q_A$ , and a disk  $D_{b,y}$  that  $@\{compresses$   $P_Y$  to  $Q_B$ . The boundaries of the disks  $D_{a,x} \subset A \setminus X$  and  $D_{b,y} \subset B \setminus Y$  lie on different surfaces so the disks can be made disjoint.

The curve  $@D_{a,x}$  is the union of two arcs,  $P_X$  and  $Q_A$ . A collar of  $D_{a,x}$  is a 3-ball whose boundary is the union of two disks  $D$  parallel to  $D_{a,x}$  and a collar of each of  $P_X$  and  $Q_A$  respectively. The 3-ball can be used to define an isotopy of  $P_X$  that replaces a collar neighborhood of  $P_X$  with the union of the disks  $D$  and the collar of  $Q_A$ . After this isotopy (and the kinking of collars of the curve(s) of  $P \setminus Q$  on which the ends of  $P_X$  lie),  $P$  and  $Q$  will be aligned along an essential surface  $P_0 = Q_0$  with  $\chi(P_0) = -1$ . Repeat the process on  $D_{b,y}$ . □

**Theorem 9.4** *Suppose  $M = A [P B = X [Q Y$  are two genus two Heegaard splittings of a hyperbolic closed 3-manifold. Then the splittings are both some variation of one of the examples of Section 4. In particular,  $P$  and  $Q$  commute.*

**Proof** Following 9.3, we assume that the surfaces  $P$  and  $Q$  are aligned along a subsurface  $P_0 = Q_0$  with  $\chi(P_0) = -2$ , and each component of  $@P_0 = @Q_0$  is essential in all four handlebodies  $A; B; X; Y$ . We may further assume that no component of  $P_0$  is an annulus, for any such annulus could be removed by a small isotopy of the surfaces, perhaps creating a curve of transverse intersection. We further assume that  $jP_+ \setminus Q_+j$  has been minimized by isotopy rel  $@P_0$ . Then  $P_X; P_Y; Q_A$  and  $Q_B$  all consist of incompressible annuli. Any of these annuli that is  $@\{parallel$  in the handlebody in which it lies could be removed by an isotopy (possibly adding it to  $P_0$  or  $Q_0$ ), so in fact all these annuli are essential.

According to 5.2 the ends of  $P_X$  in  $Q$  can be isotoped to lie parallel to (at most) two essential non-separating simple closed curves in  $Q$ , and similarly for  $P_Y$ . Since ends of  $P_X$  and  $P_Y$  can't cross, there are (at most) three simple closed curves  $c_1; c_2; c_3$  in  $Q$ , decomposing  $Q$  into two pairs of pants, so that any component of  $@P_X [ @P_Y$  is parallel to one of the three curves. Moreover, if all three curves  $c_1; c_2; c_3$  are ends of annuli of  $P - Q$  then the number of annuli cannot be high, because of the following "Rule of Three":

**Lemma 9.5** *If three or more ends of  $P_X$  are parallel in  $Q$  then at least one must attach to an end of a curve in  $P_Y$ . In particular, if  $P_X$  has three or more ends at each of two of the curves  $c_i$ , then all ends of  $P_Y$  must also be parallel to those two curves.*

**Proof** Immediate. (See Figure 26.) □

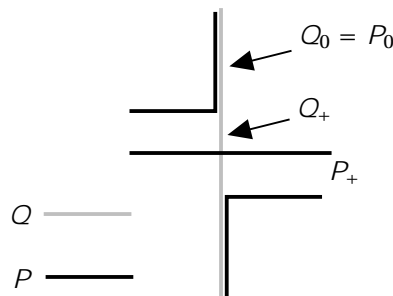

Figure 26

We now consider the possibilities:

**Case 1**  $P_Y = ;$

Consider the annuli  $P_X$  in the context of Lemma 5.6. By the Rule of Three (Lemma 9.5) and the fact that  $P_X$  is separating,  $l(@P_X) = (2;0;0;0)$  or  $(2;2;0;0)$ . So either  $P_X$  is a single annulus with both ends parallel to the same curve  $c_1$  in  $Q$ , or two annuli, one with both ends at  $c_1$  and the other with both ends at  $c_2$ , or two annuli, each with one end at  $c_1$  and one at  $c_2$ . In the first two cases, since  $P_X$  is essential in  $X$ ,  $P$  and  $Q$  differ by a cabling into  $X$ , either on one longitude (example 4.1, Variation 1. See Figure 27) or on two longitudes (example 4.2, Variation 1, with one Dehn surgery done at each site; see Figure 28.)

If  $P_X$  is a pair of annuli, each with one end at  $c_1$  and one at  $c_2$  then the annuli are non-separating. The annuli may both be longitudinal (hence parallel) in

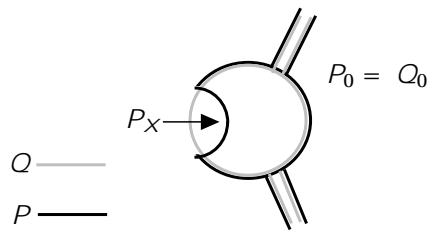

Figure 27

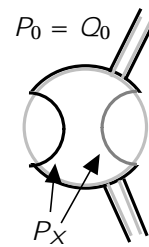

Figure 28

$Q$ . Then the splittings appear as 4.4, Variation 1 (when the  $c_i$  are longitudes of  $P$  as well; see Figure 29) or Variation 2, with the Dehn surgery curve in one of  $b$  (when the  $c_i$  are twisted in  $P$ ; see Figure 30). The annuli  $P_X$  could be twisted and not parallel, so that lying between them is a solid torus on which their cores are torus knots. (See Figure 31.) This is 4.4, Variation 2, with Dehn surgery in  $a$ . Or they could be twisted and parallel, corresponding to the same Variation but with Dehn surgery in one of  $a$ . Note that Variations 3 and 4 don't arise, since  $M$  is hyperbolike.

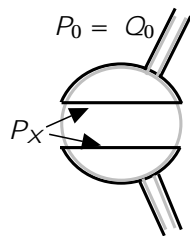

Figure 29

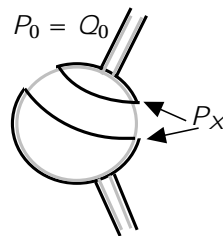

Figure 30

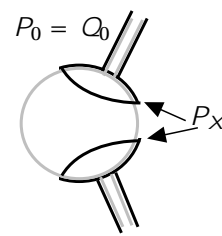

Figure 31

**Case 2**  $P_X$  and  $P_Y$  are both non-empty and the end of each curve in  $@P_X [ @P_Y$  is parallel to one of  $c_1$  or  $c_2$ .

If at least one annulus in each of  $P_X$  or  $P_Y$  is non-separating, then together they would give a non-separating, hence essential, torus in  $M$ . This contradicts our assumption that  $M$  is hyperbolike. So we may as well assume that each annulus in  $P_Y$  is separating. Hence the ends of  $P_Y$  are twisted in  $Y$ . They cannot then be twisted in  $X$ , since  $M$  is hyperbolike, so  $P_X$  is a collection of parallel non-separating longitudinal annuli in  $X$ .

If  $P_Y$  has ends at both  $c_1$  and  $c_2$  (as happens automatically if  $P_X$  has more than two components) then both curves are twisted in  $Y$ . Attach a non-separating

annulus in  $X$  with ends at  $c_1$  and  $c_2$  to the torus (or tori) in  $Y$  on which the  $c_i$  are twisted. The boundary of the thickened result would exhibit a Seifert manifold in  $M$ , again contradicting the assumption that  $M$  is hyperbolic. We conclude that  $P_X$  has exactly two components and that  $P_Y$  has ends only at  $c_1$ , say.

If there were more than two annuli in  $P_Y$  (hence more than four ends of  $@P_Y$ ) there would have to be more than two ends of  $P_X$  at  $c_1$ , so we conclude that  $P_Y$  is made up of one or two annuli. If it's two annuli, necessarily separating and parallel in  $Y$ , then the relation between  $P$  and  $Q$  can be seen as follows (See Figure 32): In 4.4, Variation 2 let  $P$  be the splitting given there with Dehn surgery curve in  $a_+$  and  $Q$  be the same splitting given there but with Dehn surgery curve in  $a_-$ . To view these simultaneously as splittings of the same manifold  $M$ , of course, the Dehn surgery curve has to be moved from  $a_+$  to  $a_-$ , dragging some annuli along, until the splitting surfaces  $P$  and  $Q$  intersect as described.

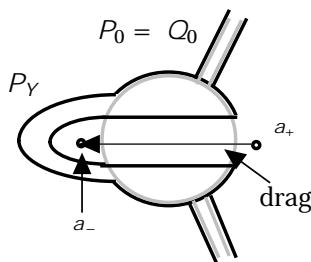

Figure 32

If  $P_Y$  is a single annulus, it must have one end on  $P_0$  and one end on an end of  $P_X$ , and the annulus is twisted in  $Y$ . The initial splitting by  $Q$  is as in Example 4.4 Variation 1 ( $X = A_- [ \ ]$ ), with a Dehn surgery curve lying in  $b_+$ , say. If the splitting is altered by first putting the Dehn surgery curve in  $a_+$  (yielding the same manifold  $M$ ), then altering as in Example 4.4 (ie, considering  $A [P B$  where  $B = B_- [ \ ]$ ) and then dragging the Dehn surgery curve from  $a_+$  to  $b_+$ , pushing before it an annulus from the 4-punctured sphere along which  $A_-$  and  $B_-$  are identified, we get the splitting surface  $P$ , intersecting  $Q$  as required. (See Figure 33.)

**Case 3** Some end component(s) of  $P_X$  or  $P_Y$  lie parallel to each of  $c_1; c_2; c_3$ . Then one of the  $c_i$ , say  $c_1$ , is parallel only to ends of  $P_X$ , and at most (hence exactly) two of them. Another, say  $c_3$ , is parallel only to ends of  $P_Y$  (again exactly two).

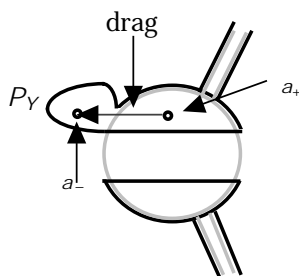

Figure 33

**Subcase a** No ends of  $P_Y$ , say, are parallel to  $c_2$ .

Then all ends of  $P_Y$  are parallel to  $c_3$  and some ends of  $P_X$  are parallel to  $c_1$  and some to  $c_2$ . So, by the Rule of Three (Lemma 9.5),  $P_Y$  is a single separating annulus with ends at  $c_3$  and  $P_X$  is either a pair of separating annuli, one each with ends at  $c_1$  and  $c_2$ , or a pair of non-separating annuli, each having one end at  $c_1$  and one end at  $c_2$ . (See Figures 34 and 35.) It follows that when  $X$  is cut open along  $P_X$  the component that contains  $c_3$  is a genus two handlebody in which the cores of the annuli  $P_X$  appear as separated curves (at least one a longitude), and  $c_3$  is a longitude not parallel to either (since  $P$  splits  $M$  into handlebodies). Then the technical Lemma 7.4 ( $c_3$  here becomes  $c_2$  there) precisely places  $c_3$  with respect to the annuli. In particular, if the  $P_X$  are separating, (so the argument is precisely symmetric moving from  $P$  back to  $Q$ ), the splitting is given in Example 4.1, Variant 2. If the  $P_X$  are non-separating, the splitting is given in Example 4.4, Variation 5 (if  $c_1$  and  $c_2$  are not twisted in any of the handlebodies) or Variation 6, with one Dehn surgery curve appropriately placed (if the curves  $c_1$  or  $c_2$  are twisted in a handlebody).

**Subcase b** Ends of both  $P_X$  and  $P_Y$  are parallel to  $c_2$ .

The curve  $c_2$  can be twisted in at most one of  $X$  and  $Y$ , so assume that  $c_2$  is not twisted in  $X$ . By 5.6 this means that  $P_X$  is a pair of parallel annuli running between longitudes  $c_1$  and  $c_2$  of  $X$ .

$P_Y$  has two ends at  $c_3$  and, as in Case 2, either 2 or 4 ends at  $c_2$ . If the annuli are separating and there are 4 ends of  $P_Y$  at  $c_2$  then the cores of the two annuli whose ends are at  $c_2$  cobound an annulus in  $Y$ . It follows from 7.2 that any twisted or longitudinal curve in  $P$  must be parallel to one of these cores. But that would make the core of the annulus in  $P_Y$  at  $c_3$  parallel to one of these cores, hence  $c_3$  parallel to  $c_1$  or  $c_2$  in  $P$ . Since this is impossible, the case does not arise.

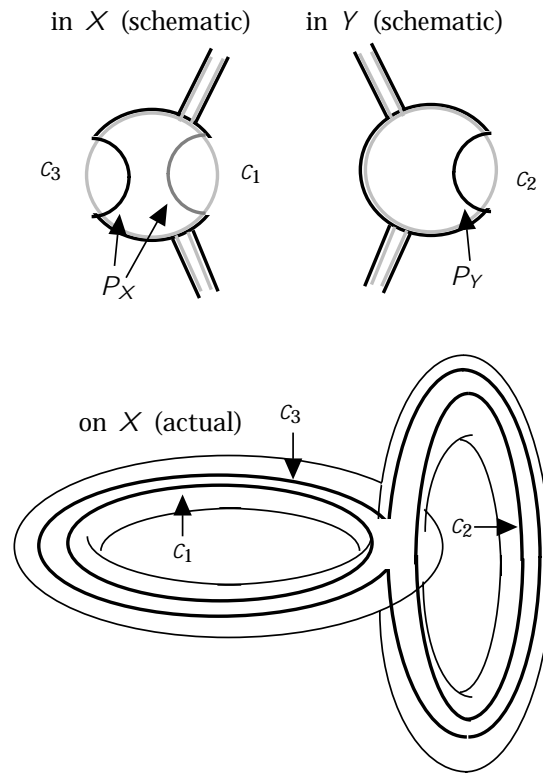

Figure 34

Suppose the annuli in  $P_Y$  are separating and there are two ends of  $P_Y$  at  $c_2$ . Then  $P_Y$  consists of two separating annuli,  $A_2$  which has both ends at  $c_2$  and  $A_3$  which has both ends at  $c_3$ . The situation is analogous to the last example in Case 2 above,  $K4$  variation 2, with Dehn surgery curve in  $b_+$  when  $\Sigma$  is attached to  $A_-$ , and in  $a_+$  when  $\Sigma$  is attached to  $B_-$ . But the presence of  $A_3$  adds the additional complexity of Variation 6:  $\Sigma$  is simultaneously moved from  $B_-$  to  $A_-$ .

If the annuli in  $P_Y$  are not all separating, and  $P_Y$  has four ends at  $c_2$  then  $P_Y$  consists of a pair of non-separating annuli with ends at  $c_2$  and  $c_3$  and a single separating annulus with ends at  $c_2$ . Much as in the other case when there were 4 ends at  $c_2$  this leads to a contradiction, this time with Lemma 7.3. (See Figure 36.)

The final possibility is that the annuli in  $P_Y$  are not all separating, and  $P_Y$  has two ends at  $c_2$ . Then  $P_Y$  consists of a pair of non-separating annuli with ends



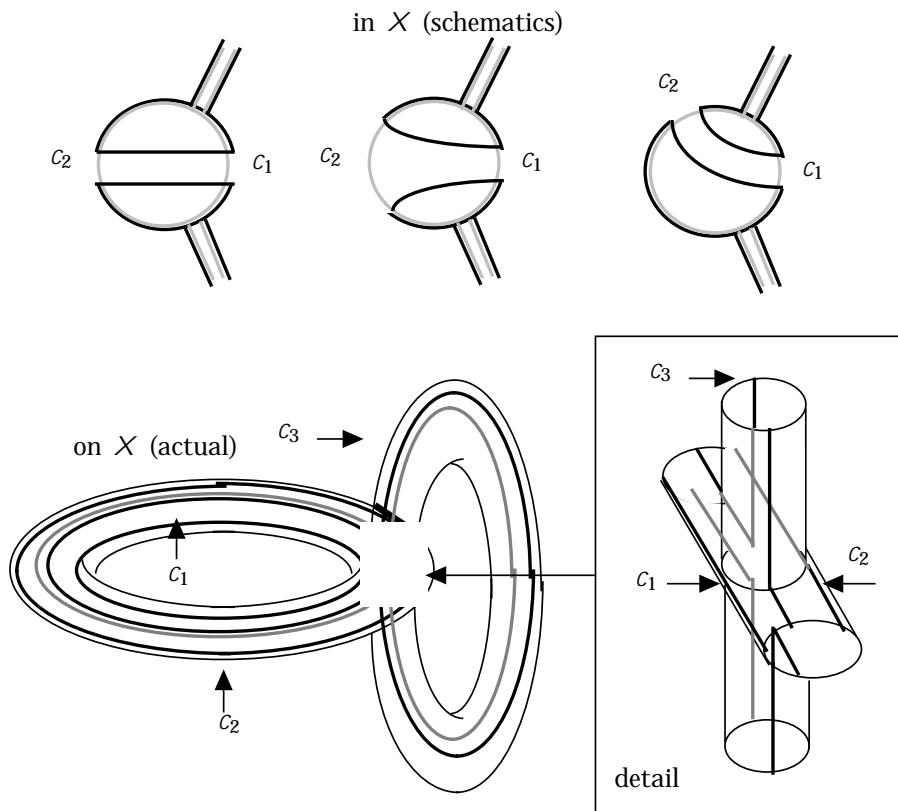

Figure 35

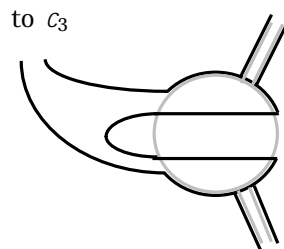

Figure 36

at  $c_2$  and  $c_3$ . (See Figure 37).

We will show that this case, too, cannot arise, for if it did:

**Claim** *Then  $M$  is a Seifert manifold.*

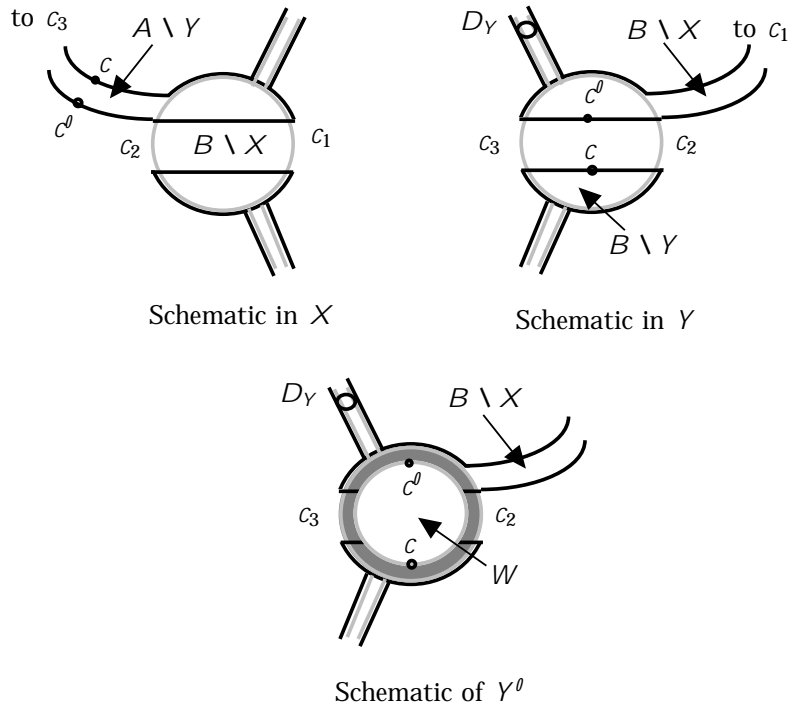

Figure 37

**Proof of claim** Suppose, with no loss of generality, that the (solid torus) region between the annuli  $P_Y$  in  $Y$  lies in  $A$ . Then  $B \setminus Y$  is a genus two handlebody  $H$  in which the two annuli  $P_Y$ , have cores  $c; c^d$ , which are separated curves on the boundary.  $B$  is obtained from  $H = B \setminus Y$  by attaching the region  $(B \setminus X) = (\text{annulus } I)$  that lies between the annuli  $P_X$ . One end of *annulus*  $I$  is attached to a curve which is parallel in  $@Y$  to  $c_2$  and in  $@H$  to  $c^d$  say. The other end is attached at  $c_1$ . It follows from 7.6 that  $c$  is longitudinal in  $H$ , and  $c_1$  crosses exactly twice a disk  $D_Y \subset H$  that separates  $c$  and  $c^d$ . Notice that  $Y$  is obtained from  $H$  by attaching a thickened annulus with ends at  $c$  and  $c^d$ . So  $D_Y$  is a non-separating meridian disk for  $Y$ .

Cut  $Y$  open along  $D_Y$  to get a solid torus containing  $P_Y$  and remove from this solid torus all but a collar of the boundary. That is, remove a solid torus  $W \subset Y$  whose complement  $Y_-$  in  $Y$  consists of a collar of  $@W$  to which a 1-handle, with cocore  $D_Y$ , is attached. Note that the two annuli  $P_Y$  intersect  $Y_-$  in four parallel spanning annuli. Let  $s$  denote the slope of their ends on  $@W$ .

We will show that  $M - W$  is a Seifert manifold. In fact, we will show that  $M - W$  fibers over the circle with fiber the three-punctured sphere (ie, the pair of pants) and this suffices. Then a Seifert manifold structure on  $M$  will be obtained by filling in the solid torus  $W$ .

Another way to view the compression body  $Y_-$  is to begin with  $\text{torus} \times I$  and attach to it a genus two handlebody  $H^0 \subset H$  by attaching collars of two separated longitudes  $c; c^0 \subset H^0$  to two annuli in  $\text{torus} \times \text{flg}$ . The annuli have slope  $\frac{1}{2}$ . Note that whereas  $c^0$  may be twisted in  $H$ , we've obtained  $H^0$  by removing a solid torus so large it contains any cable space, so the attachment circle  $c^0$  is indeed longitudinal in  $H^0$ . Now when  $(B \setminus X) = (\text{annulus} \times I)$  is attached to  $Y_-$ , one end is attached to  $\text{torus} \times \text{flg}$  along a curve parallel to  $c$  and the other end is attached along the curve  $c_1 \subset H$  which crosses  $D_Y$  twice. Then by Lemma 7.6,  $H^0 \cup (B \setminus X)$  is a genus two handlebody homeomorphic to  $V \times I$ , where  $V$  is a pair of pants whose boundary is the triple of curves  $c; c_1; c^0$ . The upshot is that  $Y_- \cup (B \setminus X)$  can be viewed as  $\text{torus} \times I$  with  $V \times I$  attached by identifying each of  $c \times I; c_1 \times I; c^0 \times I$  with different parallel annuli on  $\text{torus} \times \text{flg}$ . Each annulus has slope  $\frac{1}{2}$ .

What remains of  $M - W$  is the genus two handlebody  $X \setminus A$ . When this is attached along its entire boundary, it's easy to see that the three annuli remaining on  $\text{torus} \times \text{flg}$  are identified with annuli corresponding to two distinct separated longitudes  $d_1; d_2$  in  $\partial(X \setminus A)$  (both parallel to  $c_2$  in  $\partial X$ ) and an annulus whose core is  $c_3$ . The fact that  $A$  is constructed by attaching  $(A \setminus Y) = (S^1 \times D^2)$  to the handlebody  $A \setminus X$  along  $c_2$  and  $c_3$  means (see Lemma 7.7) that  $A \setminus X$  can be viewed as  $V^0 \times I$ , where  $V^0$  is a pair of pants with  $\partial V^0$  the three curves  $d_1; d_2; c_3$ . The upshot is that adding in  $A \setminus X$  is the same as attaching  $V^0 \times I$  by identifying  $\partial V^0 \times I$  with the remaining annuli of  $\text{torus} \times \text{flg}$  and then the rest of the boundary,  $V^0 \times \partial I$ , with  $V \times \partial I$ . But the union of  $V \times I$  and  $V^0 \times I$  fibers over the circle with fiber a pair of pants. It's easy to show then that this manifold is also Seifert fibered by circles transverse to the pair of pants, with a generic fiber running through each of  $V \times I$  and  $V^0 \times I$  exactly three times and, in  $\text{torus} \times \text{flg}$  crossing a curve with slope  $\frac{1}{2}$  exactly once. The base is a disk and there are two exceptional fibers, each of type  $(3; 1)$ .

Now  $M$  is created from the Seifert manifold just described by filling in a solid torus along its boundary, namely the solid torus that was removed from  $Y$  at the beginning. The result is either a Seifert manifold (if the filling slope differs from that of the fiber) or a reducible manifold, if the filling slope is that of the fiber. In any case,  $M$  is not hyperbolic.  $\square$

## 10 Heegaard splittings when tori are present

Suppose  $M$  is a closed orientable irreducible 3-manifold of Heegaard genus two,  $M$  is not itself a Seifert manifold, and  $M$  contains an essential torus. Following Section 6, let  $F$  denote the collection of tori that constitute the canonical tori of  $M$ . The discussion of Section 6 shows that a genus two Heegaard splitting  $M = A [P B$  can be isotoped to intersect  $F$  so that there is exactly one component (here to be denoted  $W_P$ ) of  $M - F$  which contains a non-annular part of  $P$ . Moreover,  $V_P = M - W_P$  is a Seifert manifold with at most two components, each of which  $P$  intersects in  $\ell$  banded annuli. (More is shown there about  $V_P$ ).  $W_P$  is atoroidal, but could perhaps be a Seifert manifold over a disk with two exceptional fibers or over an annulus or Möbius band with one exceptional fiber, as long as the  $\ell$ -banding doesn't match a  $\ell$ -banding of  $V$ . As in Section 6 we let  $P_- = P \setminus W_P$  and let  $A_- = A \setminus W_P; B_- = B \setminus W_P$  have spines  $\ell_A$  and  $\ell_B$ .

Consider how two different such splittings  $M = A [P B = X [Q Y$  compare. One possibility is

**Example 10.1**  $W_P = V_Q$  and  $W_Q = V_P$ .

Then in each of  $W_P$  and  $W_Q$  there are essential annuli whose slopes differ from those of the Seifert  $\ell$ -banding  $\ell_{V_P}$  and  $\ell_{V_Q}$  respectively. Exploiting Lemma 6.2 and Proposition 6.3 we can write down explicit and simple descriptions of all variations possible here and deduce that, for these two splittings, the commutator  $[P, Q] [P^{-1}, Q^{-1}$  can be obtained by Dehn twisting around the unique essential torus  $F$ .

So henceforth we will assume that  $W_P = W_Q$  and  $V_P = V_Q$  and revert to  $W$  and  $V$  as notation. Then  $W = A_- [P_- B_- = X_- [Q_- Y_-$ , where the splitting surface  $Q_-$ , the handlebodies  $X_-; Y_-$  and the spines  $\ell_X$  and  $\ell_Y$  are defined analogously to  $P_-; A_-; B_-; \ell_A$  and  $\ell_B$ .

**Theorem 10.2** *Suppose  $M = A [P B = X [Q Y$  are two non-isotopic genus two Heegaard splittings of an irreducible orientable closed 3-manifold  $M$ . Suppose  $M$  contains an essential torus. Then either the splittings are isotopic, or the relation between the Heegaard splittings is described in one of the variations of one of the examples in Section 4 or in Example 10.1. In particular, the commutator  $[P, Q] [P^{-1}, Q^{-1}$  can be obtained by Dehn twists around essential tori in  $M$ , and the two splittings become equivalent after a single stabilization.*

**Proof** Isotope  $P$  and  $Q$  so that they each intersect the canonical tori  $F$  of  $M$  as described in (possibly different cases of) Section 6, and continue with the same notation. There are two possibilities:

**Case 1**  $@P_-$  and  $@Q_-$  have the same slope on each component of  $F$ .

Then the annuli in  $A_-$  and  $B_-$  can be chosen to overlap so that their complements in  $F$  are disjoint. This means that during the sweep-outs of  $W - (A_- \cup B_-)$  and  $W - (X_- \cup Y_-)$  determined by  $P_-$  and  $Q_-$  respectively,  $@P_- \setminus @Q_- = \emptyset$ . (See the discussion preceding 6.2 for a description of the sweepout). In particular, the generic intersection of  $P_-$  and  $Q_-$  during the sweepout consists of closed curves. Apply the argument of Sections 8 and 9 almost verbatim to the two sweep-outs. The upshot is a positioning of  $P_-$  and  $Q_-$  so that they are aligned except along some collection of subannuli. That is,  $(P_-)_X = \text{closure}(P_- - Y_-)$  and  $(P_-)_Y = \text{closure}(P_- - X_-)$  consist of incompressible annuli in  $X_-$  and  $Y_-$  respectively and none of these is parallel in  $X_-$  or  $Y_-$  to a subannulus of  $Q_-$ .

Consider first of all the case in which  $P_-$  and  $Q_-$  are both 4-punctured spheres, so any incompressible annulus with boundary disjoint from  $F$  is  $@$ -parallel. (This excludes only the case when  $V$  fibers over the circle with two exceptional fibers and either  $P$  or  $Q$  intersects  $V$  as in the single annulus case.) Then  $(P_-)_X$  and  $(P_-)_Y$  consist entirely of annuli parallel to one of the two annuli in  $F \setminus X_-$  (resp.  $F \setminus Y_-$ ). It's easy to see that these can be removed by an isotopy of  $P_-$  which slides  $@P_-$  around  $F$ . Thus, after an isotopy of  $P_-$  which may move the boundary of  $P_-$ , we can make  $P_-$  and  $Q_-$  coincide. Such an isotopy is equivalent to Dehn twists around tori in  $F$ . The fibered annuli  $P \setminus V$  and  $Q \setminus V$  may also differ within  $V$ , but can be made to coincide by Dehn twists around essential tori in  $V$ .

Suppose now that  $P_-$  and  $Q_-$  are both twice-punctured tori. This can arise when  $V$  fibers over the disk with two exceptional fibers, and both  $P$  and  $Q$  intersect as in the single annulus case. Then more complicated essential annuli  $(P_-)_X$  and  $(P_-)_Y$  can occur. In any of  $A_-; B_-; X_-; Y_-$ , say  $X_-$ , essential annuli with boundaries disjoint from  $F$  can be of two types: parallel annuli non-separating in  $Q_-$ , each with one end parallel to  $@Q_-$  and the other parallel to a curve  $c^d \subset Q_-$ ; or parallel separating annuli, both ends parallel to the same single twisted curve  $c^d \subset Q_-$ . (See Figure 38.)

Since  $F$  is the set of canonical tori of  $M$ , there is no essential torus in  $W$ , nor is there an essential annulus with end having the slope of  $@Q_-$  ( $= @P_-$ ). It follows that one of  $(P_-)_X$  or  $(P_-)_Y$  is empty. For if both  $(P_-)_X$  and  $(P_-)_Y$

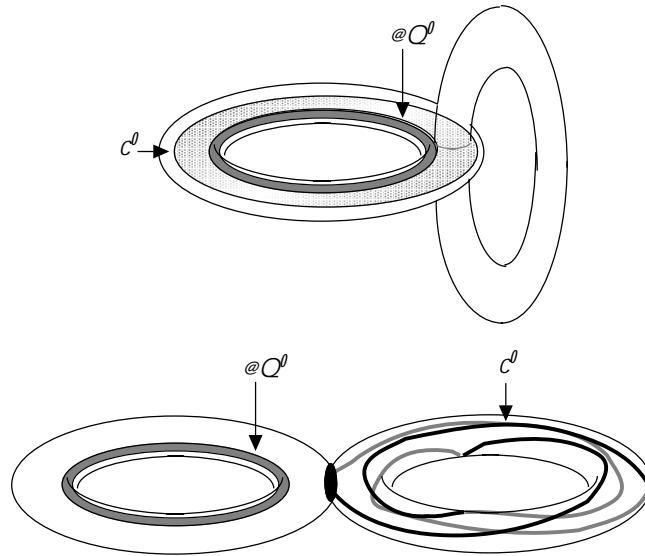

Figure 38

were non-empty and separating, then copies of each could be matched up along their boundaries in  $Q_-$  to create an essential separating torus in  $W$ . If both were non-separating, then their ends could be matched up to create an essential non-separating torus in  $W$ . If  $P_Y$  were separating and  $P_X$  were non-separating (or vice versa), then an annulus of  $P_Y$  attached to two annuli in  $P_X$ , each with their other end on  $F$ , would give an essential annulus in  $W$  with slope the ber of  $V$ .

So we may assume  $(P_-)_Y$  is empty, and so  $(P_-)_X$  consists of one separating or two parallel and non-separating annuli. If  $(P_-)_X$  is a single separating annulus then the splittings are completely described by Example 4.2 Variation 1, with three Dehn surgery curves. One pair produces  $V$  the other cables  $A$  into  $B$  to produce  $X [Q Y$  and vice versa.

Suppose  $(P_-)_X$  consists of two parallel non-separating annuli and suppose that the region between the parallel annuli of  $(P_-)_X$  lies in  $A_-$ , say. Then  $A_- \setminus X_-$  can be viewed as  $= square S^1$ , where  $(P_-)_X$  comprises two opposite annuli in the boundary and the other pair of opposite annuli is  $(Q_-)_A$ . Since the annuli  $(P_-)_X$  are @compressible in  $X$  it follows that, viewed in  $P$ , one of the annuli is longitudinal in  $B$ . Similarly, one of the annuli in  $(Q_-)_A$  is longitudinal in  $Y$ . This su ces to characterise the two splittings as those of Example 4.4 Variation 3, with one of the Dehn surgery curves placed in one of  $a$  and the other in one of  $b$ .

Finally, suppose that say,  $P_-$  is a 4-punctured sphere, and  $Q_-$  is a twice-punctured torus. This means that  $V$  fibers over the disk with two exceptional fibers; that  $P$  intersects  $V$  as in the parallel annuli case; and that  $Q$  intersects  $V$  as in the single annulus case. Then the argument is a mix of earlier ideas: Once again, after an isotopy of  $@Q_-$  on  $F$  we can ensure that the annuli in  $Q_-$  which are not aligned with  $P_-$  are not contained in collars of  $@Q_-$  and, in  $A_-$  and  $B_-$ , these annuli are parallel to the annuli  $F \setminus A$  and/or  $F \setminus B$  respectively. It follows that  $P_{-0}$  (that is, the part of  $P_-$  that is aligned with  $Q_-$ ) is a single 4-punctured sphere. It follows then that the complement of  $Q_{-0}$  is a single collection of parallel annuli. Since  $P_-$  has two more boundary components than  $Q_-$  the annuli of  $P_-$  not aligned with  $Q$  include collars of exactly two components of  $@P_-$ . Since no component of  $P_{-0}$  is an annulus, it follows that in fact  $Q_-$  is aligned with  $P_-$  except for a single annulus, lying in  $A_-$  say. That annulus cuts off collars of two components of  $P_-$ , which are the only parts of  $P_-$  not aligned with  $Q_-$ . Put another way:  $Q_-$  is obtained from  $P_-$  by attaching a copy of an annulus component of  $F \setminus A$ . Then the setting is exactly as in Lemma 6.1 and preceding. In particular, both splittings are described in 4.4 Variation 3.

**Case 2**  $@P_-$  and  $@Q_-$  have different slopes on some component of  $F$ .

Then  $V$  is the neighborhood of either a one-sided Klein bottle or a non-separating torus, for otherwise the slope of  $P_-$  and  $Q_-$  must be that of the unique Seifert fibering of  $V$ . We will concentrate on the latter, for the proof in the former, more specialized, case is similar but easier: A combinatorial proof comparing  $P_-$  and  $Q_-$ , much as in the non-separating torus case below, shows that there is an essential annulus in  $W$ , so  $W$  is in fact a Seifert piece attached to  $V$ , but the fibers do not match. This is Example 10.1.

The argument when  $V$  is the neighborhood of a non-separating torus will eventually bear a striking resemblance to the hyperbolic case, Section 8.

$W$  is the manifold obtained by cutting open along the non-separating torus  $F$ .  $@W$  consists of two copies of  $F$ , which we denote  $@W$ . We will denote  $@P_- \setminus @W$  by  $@P$  (and similarly for  $@Q$ ).

**Subcase 2a**  $W = T^2 \setminus I$ .

Then  $M$  is the mapping cylinder of a torus. It is shown in [18] (more detailed argument relevant here can be found also in [8]) that the only such mapping cylinders allowing a genus two splittings are those with monodromy of the form

$$L = \begin{pmatrix} m & -1 \\ 1 & 0 \end{pmatrix} ;$$

If, for example,  $A \lrcorner_P B$  is the genus two splitting, then with respect to the coordinates for which  $L$  is the monodromy, the slope of  $P_-$  is  $\begin{pmatrix} 0 \\ 1 \end{pmatrix}$ . Hence, when we consider both splittings  $A \lrcorner_P B$  and  $X \lrcorner_Q Y$ , it follows that there is an automorphism of the torus  $F$  that carries the slope of  $P_-$  to that of  $Q_-$  and this automorphism must commute with  $L$ . If  $|mj| = 2$  it is easy to check that the matrix of such an automorphism is a power of  $L$ . It follows that the original splitting  $P$  can be "spun" around the mapping cylinder until the slopes of  $P_-$  and  $Q_-$  coincide, and so, as above,  $P$  and  $Q$  are isotopic. (See [8] for more detailed explanation.)

If  $|mj| = 3$  then  $M$  is a solvmanifold, whose Heegaard splittings are described in [8]: With precisely two exceptions, each solvmanifold has exactly one isotopy class of irreducible Heegaard splittings (sometimes genus two, sometimes genus three). The two exceptions, corresponding to the case  $|mj| = 3$ , each have exactly two genus two splittings, for which the associated standard involutions commute, as desired.

**Subcase 2b**  $W$  contains an essential spanning annulus

That is,  $W$  contains an essential annulus  $A$  with one end on each of  $@ W$ . These ends are denoted  $@ A$ . Note that if  $W$  contains two essential spanning annuli of different slopes then, since  $M$  is irreducible,  $W = T^2 \times I$  and we are done by the previous subcase. So we may as well assume that  $W$  contains a unique (up to proper isotopy) essential spanning annulus  $A$ .

**Lemma 10.3** *Neither end of  $A$  is parallel to  $@P_-$  (or  $@Q_-$ ).*

**Proof** If both ends are parallel to  $@P_-$ , then, arguing as in 6.2, we can arrange that  $P_- \setminus A$  consists of essential closed curves, parallel to the core of  $A$ . Then isotope  $A$  to minimize the number of curves; the result is that  $A$  can be made disjoint from  $P_-$  and so lies entirely in  $A_-$  or  $B_-$ . But this would imply that  $A$  or  $B$  contained an essential torus, obtained by isotoping the two curves  $@ A$  so that they coincide in  $F$ . But a handlebody does not contain an essential torus.

If one end of  $A$  is parallel to  $@P_-$  and the other end is not, then the involution  $\rho_j W$ , which interchanges  $@^+ W$  and  $@^- W$ , carries  $A$  to a second spanning annulus in  $W$  whose slope at each end differs from that of  $A$ , contradicting our hypothesis that  $W$  contains a unique essential spanning annulus  $\square$



**Lemma 10.4**  $P_-$  does not contain two disjoint arcs  $\alpha$  and  $\beta$ , the former boundary compressing via a disk in  $A_-$  and the latter via a disk in  $B_-$ . (Similarly for  $Q_-$ .)

**Proof** Suppose such curves existed. The ends of  $\alpha$  and  $\beta$  lie on  $@^+W$ . A  $@$ -compression of  $P_-$  along  $\alpha$  changes it to a pair of pants with one boundary component an inessential circle in  $@^+W$ . It follows that any essential arc in  $P_-$  that is disjoint from  $\alpha$  and which has both ends on  $@^-W$  will  $@$ -compress via a disk in  $A_-$ . In particular,  $\beta$  also has both ends on  $@^+W$ . (See Figure 39.) Then simultaneous  $@$ -compressions on both  $\alpha$  and  $\beta$  give two parallel spanning annuli in  $W$ . Their ends on  $@^+W$  have slope perpendicular to that of  $@^+P_-$  and on  $@^-W$  they have slope parallel to  $@^-P_-$ . The result then follows from Lemma 10.3.  $\square$

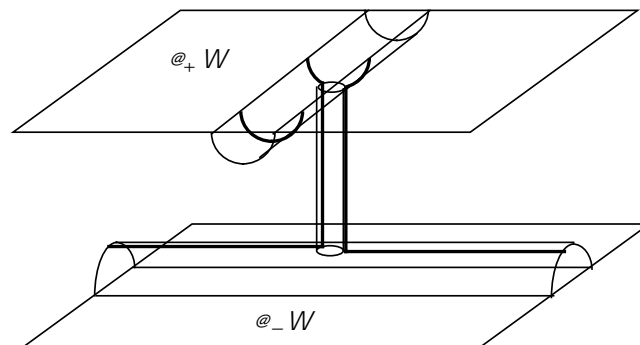

Figure 39

Following Lemmas 6.2 and 10.3, we can assume that  $P_-$  and  $Q_-$  each intersect  $A$  in pairs of spanning arcs of  $A$ . These pairs of arcs can be made disjoint by a proper isotopy of, say,  $P_- \cap W$ . As noted in the remarks following Proposition 6.3, since we only seek to understand the involutions up to Dehn twists along  $@W$ , we may allow proper isotopies in  $W$  that are not fixed on  $@P_-$ . Then, following Proposition 6.3, the involutions  $\rho_jW$  and  $q_jW$  preserve  $A$  as well as  $F$ , and induce the standard involution on the solid torus  $U = W - A$ . Of the three possibilities for such an annulus preserving involution of  $W$  (see the proof of Proposition 6.3) only one sends each boundary component of  $W$  to itself, as do  $\rho_jW \circ q_jW$  and  $\rho_jW \circ q_jW$ . Hence these products coincide with that involution. This implies that the involutions  $\rho_jW$  and  $q_jW$  commute. This implies that  $\rho$  and  $q$  commute, up to Dehn twists along  $@W$ .  $\square$

**Subcase 2c**  $W$  contains no essential spanning annulus.

This case closely parallels that of Section 8, so some of it will just be sketched. We consider the square  $I \times I$  parameterizing the sweep-outs by  $P_-$  and  $Q_-$ . We label any region in which the two surfaces are transverse with label  $A$  if there is a meridian disk of  $A_-$  whose boundary lies entirely in  $P_- - Q_-$  or if there is an arc component of  $P_- \setminus Q_-$  which  $\partial$ -compresses to  $F$  via a disk in  $A_-$ . Similarly apply labels  $B, X$ , and  $Y$ . Labels  $A$  and  $B$  (or  $X$  and  $Y$ ) can't appear on the same or adjacent regions, in part by Lemma 10.4. So there will be regions with no labels at all.

Consider how  $P_- \setminus Q_-$  appears in an unlabelled region. We can think of the intersection arcs in  $P_-$  as a graph  $\Gamma_P \subset S^2$  whose edges are the arcs of intersection and whose fat vertices are disks lying in the four boundary components of  $P_-$ . Two of these vertices,  $u_e^+$  and  $u_w^+$  lie on  $\partial^+ P_-$  and two of them  $u_e^-$  and  $u_w^-$  lie on  $\partial^- P_-$ . (See Figure 40.) Similar remarks hold for the graph  $\Gamma_Q \subset S^2$  which describes the arcs of intersection in  $Q_-$ . Label the vertices in this graph by  $v_e^+, v_w^+, v_e^-$  and  $v_w^-$  in a similar fashion.

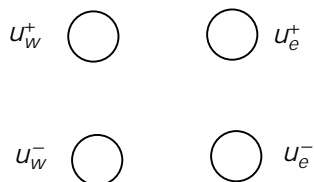

Figure 40

The valence of each vertex is  $2\rho - q$ , where  $\rho$  and  $q$  are the slopes of  $\partial P_-$  and  $Q_-$  in  $F$  respectively. Since the region has no labels, it follows that there are no trivial loops in  $\Gamma_P$  or  $\Gamma_Q$ , hence no loops at all. No loops in  $\Gamma_P$  means that any edge in  $\Gamma_Q$  has one end in one of  $v_e^+, v_w^+$  and the other end in one of  $v_e^-$  and  $v_w^-$ . (An orientation parity argument is used here.) That is, each edge has one end on a  $+$  vertex and one end on a  $-$  vertex, in fact in both graphs. If three or more edges are parallel in  $\Gamma_P$  say, then the bigons lying between them can be assembled to give a spanning annulus in  $W$ , contradicting our hypothesis. So we may as well assume that  $\rho - q = 1$ , so each vertex has valence 2.

Now restrict attention to those regions of  $I \times I$  which are unlabelled. In positionings corresponding to these regions,  $\Gamma_P$  and  $\Gamma_Q$  are bipartite graphs, so each face has an even number of edges. For each face  $F$  in  $\Gamma_P$  or  $\Gamma_Q$ , de ne

the index to be

$$J(F) = \frac{\text{jedges in } @Fj}{2} - (F):$$

The sum of the indices of all faces in  $P$  or  $Q$  is  $(P_-) = 2$ . If the sum of the indices of all faces in  $P \setminus X$  (hence also  $P \setminus Y$ ) is odd (resp. even) we say the positioning is  $P\{odd$  (resp.  $P\{even$ ), and similarly for  $Q \setminus A$ . Since there are no loops in either graph, and the valence of each vertex is 2, to say a position is  $P\{odd$  is equivalent to saying that both  $P \setminus X$  and  $P \setminus Y$  are disks with four edges. (See Figure 41.) Examination of the few combinatorial possibilities shows that  $P\{odd$  is equivalent to  $Q\{odd$ , so we will refer to unlabelled regions as either *odd* or *even*. Regions which already have labels are neither even nor odd. Note that a bigon in  $Q$  lying in  $A_-$  corresponds to a properly imbedded square  $I \setminus I$  ( $A_- \setminus X$ ) so that  $I \setminus f0g$  (resp.  $I \setminus f1g$ ) is an edge of  $P$  running between  $u_e$  (resp.  $u_w$ ), and  $f0g \setminus I$  and  $f1g \setminus I$  are spanning arcs of the annuli  $@ \setminus @ W$ , one arc in each. Such a square (with two sides spanning the annuli  $@$  and the other two essential arcs in  $P_-$ ) is called a *spanning square* in  $A_-$ . No side of a spanning square in  $A_-$  can be isotopic to a side of a spanning square in  $B_-$ , for otherwise the two squares could be assembled to give a spanning annulus, contradicting our hypothesis.

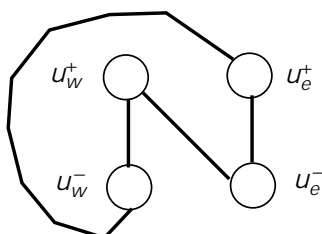

Figure 41

Expand the rules for labelling, much as in Section 8, to include the label  $A^\theta$  if there is an arc in  $Q - P$  which  $@\{compresses to  $F$  via a  $@\{compressing disk in  $A_-$ , and similarly for the other three labels  $B^\theta; X^\theta; Y^\theta$ . (The difference between  $A^\theta$  and  $A$  is that for the label  $A$  the  $@\{compressing arc needs to be an arc of  $Q \setminus P$  whereas for label  $A^\theta$  it only needs to lie in  $Q - P$ .) The labels  $A; B; A^\theta; B^\theta$  (resp.  $X; Y; X^\theta; Y^\theta$  will be called  $P\{labels$  (resp.  $Q\{labels$ .)$$$

**Lemma 10.5** *A previously unlabelled region adjacent to a region that has label  $A$  now has label  $A^\theta$ . Any region adjacent to a region that has only label  $A$  either itself has label  $A$  or it is even and has label  $A^\theta$ . Similarly for labels  $B; X; Y$ .*

**Proof** The move from the region with label  $A$  to the adjacent region corresponds to a band move. The band itself is in a face, and hence is disjoint from the edge of  $P$  that  $\partial$  compresses in  $A$ . (See Figure 42.) So the  $\partial$  compressing disk persists even after the band move, though its edge in  $P_-$  is no longer in the graph. Thus if the adjacent region had previously been unlabelled it now gets label  $A^\ell$ .

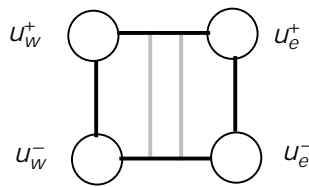

Figure 42

If the original region has only label  $A$  (and not label  $X$  or  $Y$ ) then  $A_-$  must contain two  $\partial$  compressing disks, one with edge in  $P_-$  running from  $u_e^+$  to  $u_w^+$  and the other with edge running from  $u_e^-$  to  $u_w^-$ . A band move that destroys both edges would result in an even region and so one labelled  $A^\ell$ . Otherwise one of the edges persists and the label  $A$  remains.  $\square$

**Lemma 10.6** *Any even region has two primed labels. Adjacent regions cannot both be even. If a region is odd then its labels are a subset (possibly with primes removed) of the labels of any adjacent region.*

**Proof** A region that is even corresponds to a positioning where in  $P$  there are exactly two edges running between  $u_e$  and two between  $u_w$ . The resulting bigons lie either both in  $X$  or both in  $Y$ , say the former. (See Figure 43.) Then  $P_-$  intersects  $X_-$  only in two parallel spanning squares, so  $Q_- \partial$  compresses to  $\partial W$  in the complement of  $P_-$ , forcing the label  $X^\ell$ . A dual argument works from  $Q$  to give a label  $A^\ell$  or  $B^\ell$ .

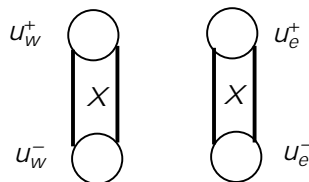

Figure 43

The band move in  $P$  corresponding to a move to an adjacent region creates either a loop, an edge corresponding to a loop in  $Q$  (eg an edge with one end on each of  $u_e^+$  and  $u_w^+$ ) or a positioning that is odd. The former two possibilities would have given the corresponding region unprimed labels, so it couldn't be even.

Consider a positioning corresponding to an odd region and, say,  $A^l$  is a label. That is, suppose an arc in  $P \setminus X$ , say,  $@$  compresses through  $A$  to  $F$ . Then the arc has an end on each of  $u_e^+$  and  $u_w^+$ , say. (See Figure 44.) If one performed this  $@$  compression one would see that there is also an arc in  $P \setminus Y$  with ends on  $u_e^-$  and  $u_w^-$  that  $@$  compresses through  $A$ . One of these two arcs will persist in any adjacent region of the graphic, since the corresponding change of positioning of  $P_-$  with respect to  $Q_-$  is via a band move in either  $P_- \setminus X$  (so the second one persists) or  $P_- \setminus Y$  (so the first persists).  $\square$

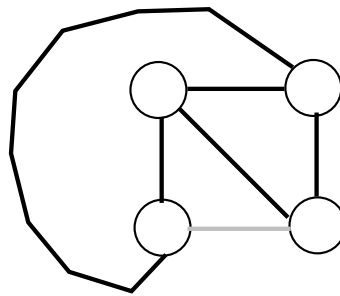

Figure 44

**Lemma 10.7** *In a positioning corresponding to an even region, with label  $A^l$ , there is a properly imbedded square  $I \subset (A_- \setminus X)$  so that  $I \cap g$  (resp.  $I \cap f$ ) is parallel to an edge of  $P$  running between  $u_e$  (resp.  $u_w$ ), and  $f \cap g \subset I$  and  $f \cap f \subset I$  are spanning arcs of the annuli  $A_- \setminus @ W$ , one arc in each. Similarly for labels  $B^l; X^l; Y^l$ .*

**Proof** Since the label is  $A^l$ , there is a  $@$  compressing disk  $D^+$  for  $P_-$ , lying in  $A_-$ , one of whose sides is a spanning arc of the annulus  $A_- \setminus @^+ W$ , say, and the other side is in  $P_-$  but disjoint from the arcs  $P_- \setminus Q_-$ . If one performed this  $@$  compression one would see that there is also a  $@$  compressing disk  $D^-$  for  $P_-$ , lying in  $A_-$ , one of whose sides is a spanning arc of the annulus  $A_- \setminus @^- W$  and the other side is also in  $P_-$  but disjoint from the arcs  $P_- \setminus Q_-$ . Piping these disks together in  $P_- - Q_-$  gives the required square. (See Figure 45.)  $\square$

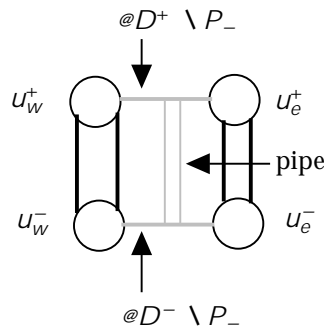

Figure 45

**Lemma 10.8** *No region can be labelled both  $A$  and  $B$  or both  $A^\theta$  and  $B^\theta$ . Similarly for labels  $X; X^\theta; Y; Y^\theta$ .*

**Proof** If both labels  $A$  and  $B$  occur then there would be a spanning annulus. If both labels  $A^\theta$  and  $B^\theta$  occur and the region is even, then 10.7 shows how to construct squares in both  $A_-$  and  $B_-$  which assemble to give a spanning annulus. If the region is odd, then note that in each of the two faces of  $P$  there is only one isotopy class of arcs with one end point on each of  $u_e^+$  and  $u_w^+$ . (See Figure 46.) It follows that the boundary compressing disks in  $A_-$  and  $B_-$  either are disjoint or would assemble to make a compressing disk for  $@^+ W$ . The latter violates the hypothesis and the former would create a spanning annulus, contradicting our hypothesis.  $\square$

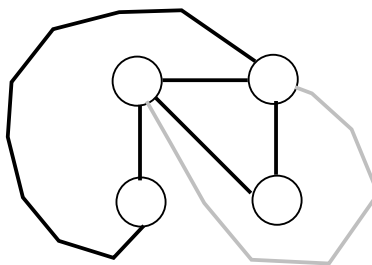

Figure 46

**Lemma 10.9** *No two adjacent regions can be labelled so that one has label  $A$  or  $A^\theta$  and the other has label one of  $B$  or  $B^\theta$ . Similarly for labels  $X; X^\theta; Y; Y^\theta$ .*

**Proof** If adjacent regions are labelled  $A$  and  $B$  then in fact one can find

disjoint  $\{$ compressing disks for  $P_-$ , one of them in  $A_-$  and the other in  $B_-$ , contradicting 10.4.

If adjacent regions are labelled  $A^\theta$  and  $B^\theta$ , then by 10.6 one is odd and so one has both labels. This contradicts 10.8.

If a region labelled  $A^\theta$  is adjacent to one labelled  $B$  then by 10.6 and 10.8, the region labelled  $A^\theta$  must be even. The label  $B$  on the adjacent region forces, by 10.5, the label  $B^\theta$  onto the region labelled  $A^\theta$ . This again contradicts 10.8.  $\square$

**Lemma 10.10** *There is an unlabelled region.*

**Proof** Following 10.8 and 10.9, the alternative is that there is a vertex whose four adjacent regions are each labelled with one label, appearing in order around the vertex:  $A$  or  $A^\theta$ ,  $X$  or  $X^\theta$ ,  $B$  or  $B^\theta$ ,  $Y$  or  $Y^\theta$ . It follows immediately from 10.6 that no region is odd and no two adjacent regions are even, so at least one of the labels is not primed. The labelling then contradicts 10.5.  $\square$

To complete the proof of Theorem 10.2 begin with the positioning of  $P_-$  and  $Q_-$  that corresponds to an unlabelled, necessarily odd, region. As in 9.3 one can align  $P_-$  and  $Q_-$ , first pushing arcs in the quadrilaterals  $(P_-)_X$  and  $(Q_-)_A$  (say) together and arcs in the quadrilaterals  $(P_-)_Y$  and  $(Q_-)_B$  together. The result is that  $P_-$  and  $Q_-$  are aligned except along a set of bigons, since (essentially by 10.5) no loops can be formed in either graph by a band move of  $P_-$  across  $Q_-$ . If two bigons were parallel there would be a spanning annulus, contradicting our hypothesis. So, after the alignment, there are exactly four bigons in  $P_- - Q_-$ , one for each possible way of connecting a vertex  $u_e^+$  or  $u_w^+$  with  $u_e^-$  or  $u_w^-$ . Similarly, there are exactly four bigons in  $Q_- - P_-$ , one for each possible way of connecting a vertex  $v_e^+$  or  $v_w^+$  with  $v_e^-$  or  $v_w^-$ . Each bigon corresponds to a spanning square. (See Figure 47.) The picture is now so explicit that  $P$  and  $Q$  can be recognized as Variation 3 of Example 4.3.  $\square$

## References

- [1] **J Birman, F Gonzalez-Acuna, JM Montesinos**, *Heegaard splittings of prime 3-manifolds are not unique*, Mich. Math. J. 23 (1976) 97{103
- [2] **J Birman, M Hilden**, *Heegaard splittings of branched coverings of  $S^3$* , Trans. Amer. Math. Soc. 213 (1975) 315{352
- [3] **M Boileau, D J Collins, H Zieschang**, *Genus 2 Heegaard decompositions of small Seifert manifolds*, Ann. Inst. Fourier, 41 (1991) 1005{1024.

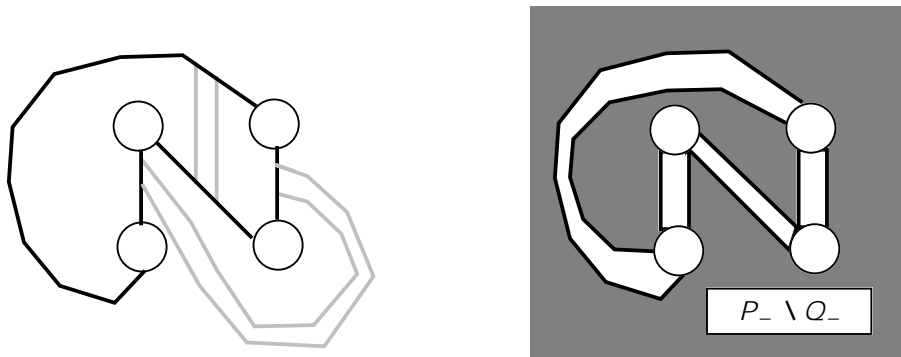

Figure 47

- [4] **M Boileau, J-P Otal**, *Groupes des diéotopies de certaines variétés de Seifert*, C. R. Acad. Sci. Paris, 303-I (1986) 19{22
- [5] **F Bonahon**, *Diéotopies des espaces lenticulaires*, Topology, 22 (1983) 305{314
- [6] **F Bonahon, J-P Otal**, *Scindements de Heegaard des espaces lenticulaires*, Ann. scient. Ec. Norm. Sup. 16 (1983) 451{466
- [7] **A Casson, C McA Gordon**, *Reducing Heegaard splittings*, Topology and its applications, 27 (1987) 275{283
- [8] **D Cooper, M Scharlemann**, *The structure of a solvmanifold's Heegaard splittings*, to appear
- [9] **C Hodgson, H Rubinstein**, *Involutions and isotopies of lens spaces*, from: \Knot theory and manifolds", Lecture Notes in Mathematics 1144, Springer (1985) 60{96
- [10] **M Jones, M Scharlemann**, *How strongly irreducible Heegaard splittings intersect handlebodies*, to appear
- [11] **W Jaco**, *Lectures on three-manifold topology*, Regional Conference series in Mathematics, no. 43, AMS (1980)
- [12] **T Kobayashi**, *Structures of Haken manifolds with Heegaard splittings of genus two*, Osaka J. of Math. 21 (1984) 437{455
- [13] **JM Montesinos**, *Sobre la conjetura de Poincare y los recubridores ramificados sobre un nodo*, Tesis, Facultad de Ciencias, Universidad Complutense de Madrid (1972)
- [14] **Y Moriah**, *Heegaard splittings of Seifert banded spaces*, Invent. Math. 91 (1988) 465{481
- [15] **Y Moriah, J Schultens**, *Irreducible Heegaard splittings of Seifert banded spaces are either vertical or horizontal*, Topology, 37 (1998) 1089{1112
- [16] **H Rubinstein, M Scharlemann**, *Comparing Heegaard splittings of non-Haken 3-manifolds*, Topology, 35 (1997) 1005{1026



- [17] **M Scharlemann**, *Heegaard splittings of compact 3-manifolds*, from: "Handbook of Geometric Topology", (R Daverman and R Sher, editors), Elsevier (to appear)
- [18] **M Takahashi, M Ochiai**, *Heegaard diagrams of torus bundles over  $S^1$* , Commentarii Math. Univ. Sancti Pauli, 31 (1982) 63{69
- [19] **O Viro**, *Linkings, 2-sheeted coverings and braids*, Mat. Sb. (N. S.), 87(129) (1972), 216{228, English translation; Math. USSR-Sb. 16 (1972) 223{226

*Department of Mathematics, University of Melbourne  
Parkville, Vic 3052, Australia*

and

*Mathematics Department, University of California  
Santa Barbara, CA 93106, USA*

Email: rubi n@ms. uni mel b. edu. au, mgscharl @math. ucsb. edu

Received: 10 September 1998      Revised: 8 June 1999