

## Research Article

# Model Reference Control for an Economic Growth Cycle Model

**Pengfei Zhao,<sup>1,2</sup> Cai Liu,<sup>1</sup> and Xuan Feng<sup>1</sup>**

<sup>1</sup> College of Geoexploration Science and Technology, Jilin University, Changchun 130026, China

<sup>2</sup> Postdoctoral Flow Station of Computer Science and Technology, Jilin University, Changchun 130012, China

Correspondence should be addressed to Pengfei Zhao, zhaopf@jlu.edu.cn

Received 20 February 2012; Revised 1 May 2012; Accepted 3 May 2012

Academic Editor: Roberto Barrio

Copyright © 2012 Pengfei Zhao et al. This is an open access article distributed under the Creative Commons Attribution License, which permits unrestricted use, distribution, and reproduction in any medium, provided the original work is properly cited.

A useful method in intelligent engineering, called model reference control (MRC), is applied in an economic control problem. The authors review the main framework of MRC and Goodwin growth cycle (GGC) model between two countries and drive the employment rate to be approximate stable in a high level by controlling the workers' share in the national income automatically. It is very helpful to constitute economic policies for a country or an economic union.

## 1. Introduction

The control problems in economy are very important for the countries or economic unions. For more than 50 years, methods which were originally created by control engineers and later fully developed by applied mathematicians have been applied to extend the theory of economic policy [1–7]. Control theory can be regarded as a collection of methods to be used by economists, just like statistics and other theories of applied mathematics. There are many economic applications of classical control theories, such as closed-loop system control [5–7], optimal control [2, 3, 8–10], stochastic control [11–14], decentralized control [15, 16], and robust control [17–19]. However, in recent years, classic economic control has become more difficult to implement, as economic behaviors become more and more complex. It is because that these classic control theories are not fit for controlling some complex economic systems. Hence, economists, engineers, and mathematicians have been exploring the possibility that advanced control techniques in engineering would be used in economics as well in these years.

Model reference control (MRC) is a famous intelligent engineering method which has a great use in controlling nonlinear complex systems [20–23]. Also, MRC is widely used in engineering problem with the aid of neural network technique. For example, see [24, 25] for the control of robots, for the control of mechanical oscillators [26], and for flight vehicles

[27–29]. In economic application, Etsuo Yamamura and his coauthors published a series of papers on MRC in both theoretical and practical fields in 1980s [30–40]. However, for the limitations of computational methods and computer hardware conditions, they have given many novel ideas and results based on some simple data sets or equations. In recent years, with the development of neural network technology and the improvement of computer performance, the application of MRC has become very simple and efficient; see [41, 42].

The aim of this paper is to expand the MRC to the field of economic control with the aid of neural network technique. The numerical results will show that MRC is an excellent tool for controlling some complex economic systems, such as Goodwin growth cycle (GGC) model between two countries, and, of course, this may be also valuable in constituting economic policies for a country or an economic union as Holt’s work [43] has done. This fully shows the efficiency and practicality of MRC with neural network structure in economic application.

The rest of this paper is organized as follows. In Section 2, we will introduce the theoretic framework of MRC; in Section 3, we will introduce the GGC model between two countries; in Section 4, we will construct a reference model by driving the expected inflation rate to be zero and show an application of MRC to the GGC model; in Section 5, we will conclude our work.

## 2. Model Reference Control

In this section, we will introduce the theoretic framework of MRC in detail.

### 2.1. System Identification

Model reference control includes two parts, system identification and controller generation. The function of system identification is to construct an algorithm for building a model from observed data automatically.

The observed data should be classified as input data and output data which are measured at discrete instants of time  $t$ . The observed data set is the training set for system identification process, and we are interested in building the identified model for the purpose of prediction and control [44]. Especially, the identified model may generate accurate prediction values and make a direct connection with the controller.

Let  $X$  and  $Y$  denote the sets of inputs and outputs for a given system. We define an operator  $T: X \rightarrow Y$  or  $y = T(x)$  for any  $x \in X$ . Obviously,  $(x, y)$  represents the given system (plant). We are interested in searching for an approximate operation  $\hat{T}_1[\cdot, p]$  to follow  $T$ . (It is a neural network, and  $p$  is an unknown parameters set.) Here the neural network model is represented by  $\hat{T}_1$  and the plant is represented by  $T$ . The simple law of determining  $\hat{T}_1[\cdot, p]$  is making the identification error

$$e_I(p_1) = \max_{x \in X} \text{dist}(\hat{T}_1(x, p_1), T(x)) \quad (2.1)$$

minimal. When we send the feedback signal  $e_I(p_1)$  back to the recurrent process, the parameter  $p_1$  may be modified and finally form an optimal approximation of the operation  $T$ . See the block diagram in Figure 1.

Note that the grey box represents the operator  $T$  (we call it “plant” in simulation process) and the green box represents the approximate operator  $\hat{T}_1$ . The Stone-Weierstrass

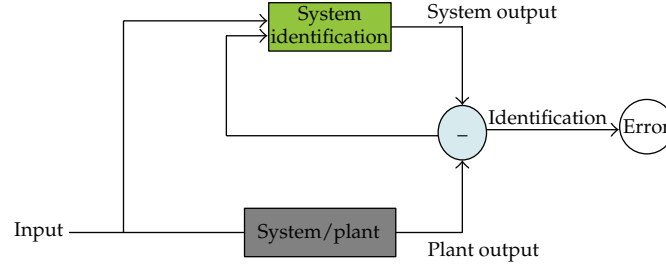

Figure 1: Block diagram of system identification.

theorem [45] guarantees that a neural network model can be preselected to approximate this plant with appropriate weight sets  $p$ ; that is,  $\hat{T}_1$  bears the structure of this preselected model [41]. The system can be described as nonlinear autoregressive-moving average (NARMA) model:

$$y(k+s) = T[y(k), \dots, y(k-n+1), x(k), \dots, x(k-m+1)], \quad (2.2)$$

where  $x(k), y(k)$  are system input and output and  $s$  is the time delay constant. To find the operator  $T$ 's best approximate  $\hat{T}_1$ , the plant model is given by

$$y(k+s) = \hat{T}_1[y(k), \dots, y(k-n+1), x(k), \dots, x(k-m+1); p_1], \quad (2.3)$$

where  $\hat{T}_1(\cdot, p_1)$  is the function implemented by neural network with three layers and  $p_1$  is the parameter vector containing all the network weights and threshold values. Since there is no delay in the network output, the network plant model can be trained using the backpropagation for feedforward networks.

## 2.2. Controller Generation

In the following, we will introduce the next process, controller generation part. Here, our main work is to design a controller to drive the plant output to follow the tendency described by the reference model.

Let  $\hat{T}_2$  bears the structure of the controller, and

$$u(k+d) = \hat{T}_2[u(k), \dots, u(k-n_u), y(k), \dots, y(k-n_y), r(k), \dots, r(k-n_r); p_2], \quad (2.4)$$

where  $r$  is the reference signal, and  $n_u, n_y,$  and  $n_r$  denote the time delays of control, system output and reference output, respectively. Define the reference error as

$$e_R(p_2) = \text{dist}(y, y_r), \quad (2.5)$$

where  $y = T(x, u)$  is the plant output,  $y_r$  is the reference signal, and  $u = \hat{T}_2(y, p_2)$  is the neural network output according to the reference signal  $r$ , system output  $y$ , and reference output  $y_r$ . See Figure 2.

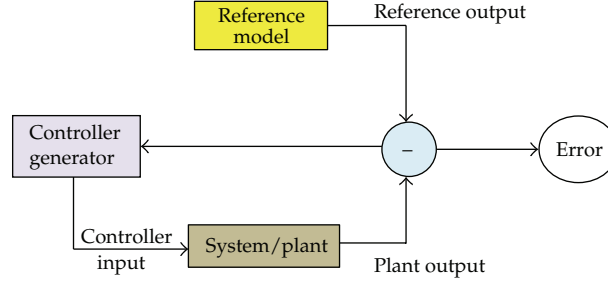

Figure 2: Block diagram of controller generation.

Note that the yellow box represents the reference model with the tendency which we desire for; the pink box represents the controller generator which is used to drive the plant output.

Automatically, the controller drives the reference error  $e_R$  to be minimum. It makes the controller generation block bear a recurrent (feedback) network which is more difficult to be trained than the feedforward networks used for plant identification. By using the backpropagation algorithm, the weights and threshold values have both direct and indirect effects on the recurrent network output. Similar to the training of plant model, the direct effect is from the explicit derivatives about the weights and threshold values. However, the indirect effect is from the implicit derivatives, and we should compute the gradients for recurrent networks with dynamic backpropagation. The recurrent network here also has three layers.

It is worth noting that if we treat the reference model as the plant, then the process of driving the plant output to be along with the reference output is just like the system identification in the first part of MRC. Hence, we can also use the learning algorithm to generate the controller. There is no essential difference between training and learning process, for they are all minimization algorithms. The only difference is that the structure of feedforward network is more complex than the one of feedback network, which needs different backpropagation algorithms to implement the computation process.

### 2.3. Model Reference Control

Treating the two parts as a whole process, we have the complete process of MRC in Figure 3.

In the following, the whole control procedures are discussed in detailed computational expressions [41]. In the whole procedures, we usually identify the plant model first and then train the controller to make the plant output follow the reference model output.

To training the plant model, we should use the backpropagation algorithm with the steepest descent learning rule. Define the performance index by

$$\hat{F}_1(p_1) = \sum_{t=1}^Q e_I^T(t) e_I(t), \quad (2.6)$$

where  $e_I(t) = y_N(t) - y_P(t)$ ,  $y_P$  and  $y_N$  are outputs of the system and the plant model, respectively, and  $p_1$  is a vector of all the weights and threshold values in neural network plant model.

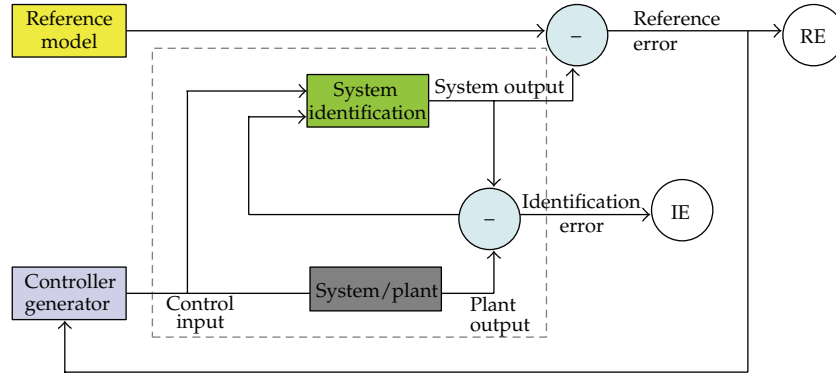

Figure 3: Block diagram of model reference control.

There are two sets of inputs of the neural network plant model, delayed controller outputs (plant inputs) and delayed outputs. The input weight matrix and layer weights matrix are denoted by  $IW$  and  $LW$ , respectively, and  $f_i$  is the transfer function. Then we have the actual output of neural network plant model as follows:

$$y_N(t+1) = f_4(n_4(t+1)), \quad (2.7)$$

where  $n_4$  is the direct layer which produces signal to compute  $y_N$ . By using the steepest descent algorithm and sensitivity index, the layer signals can be described as

$$\begin{aligned} iw_{m,i,j}^{k+1} &= iw_{m,i,j}^k - 2\epsilon \sum_{t=1}^Q e_1^T(t) s_i^k(t) p_{m,i,j}^k(t), \\ lw_{m,i,j}^{k+1} &= lw_{m,i,j}^k - 2\epsilon \sum_{t=1}^Q e_1^T(t) s_i^k(t) q_{m,i,j}^k(t), \end{aligned} \quad (2.8)$$

where  $w_{m,i,j}^k$  is the  $(i, j)$  element of the weight matrix,  $s_i^m(t) = \partial y_N(t) / \partial n_i^m(t)$ ,  $p_{m,i,j}^k(t) = \partial n_i^m(t) / \partial iw_{m,i,j}^k$ , and  $q_{m,i,j}^k(t) = \partial n_i^m(t) / \partial lw_{m,i,j}^k$ .

In the controller generation process, there are three controller inputs: delayed reference input, delayed controller outputs, and delayed plant outputs. Similar to training the plant model, we consider the performance index for controller

$$\hat{F}_R(p_2) = \sum_{t=1}^Q e_R^T(t) e_R(t), \quad (2.9)$$

where  $e_R(t) = y_P(t) - y_R(t)$ ,  $y_R$  is the reference signal and  $p_2$  is a vector consisting of all the weights and threshold values in the neural network. The process for solving the element of all the layers and determining the controller is similar to that in training plant model. After the training of plant model, the  $p_1$  is already updated in stage  $k$  by standard backpropagation; thus we have to use the updated  $p_1^{k+1}$  in the controller generation process. This process is also

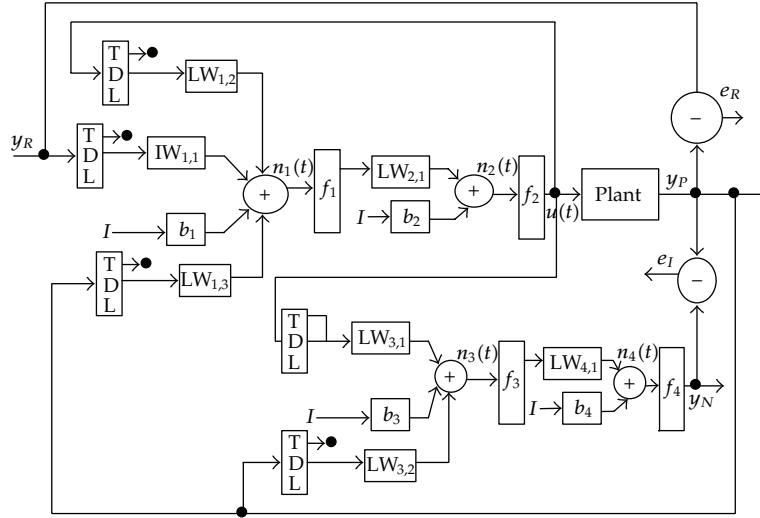

Figure 4: Network structure of model reference control [41].

called dynamic backpropagation. The whole network structure of MRC is in Figure 4. See more details in [41].

Here, we should emphasize that the reference model must provide the information which we desire for the plant output to follow. However, the reference model may or may not have any relation to the plant model. In economic control, we expect that the plant output with wide fluctuations can trace the desired reference output with approximate stable property in a high level.

### 3. Goodwin Growth Cycle Model

In this section, we will give a brief introduction of Goodwin growth cycle (GGC) model. GGC model [46] is a famous nonlinear economic model of the struggle between capital and labor for shares in national income, based on the classic Volterra-Lotka predator-prey model for populations. The control problem of original Goodwin model is not difficult to be solved, because some other important factors are not considered in the two-dimensional system, such as expected inflation rate. To show that our idea is very useful in solving the economic control problem, we will introduce a more complex Goodwin model in six dimensions.

Ishiyama and Saiki [47] considered a two-country world with capital mobility modeled by the following continuous chaotic system:

$$\begin{aligned}
 \frac{du_i}{dt} &= (\hat{\omega}_i - (\alpha_i + \hat{p}_i))u_i, \\
 \frac{dv_i}{dt} &= (\hat{Y}_i - (\alpha_i + \hat{p}_i))v_i, \\
 \frac{d\pi_i^e}{dt} &= \theta_i(\hat{p}_i - \pi_i^e),
 \end{aligned} \tag{3.1}$$

$i = 1, 2$ , where variables in country  $i$  are workers' share in national income  $u_i (\equiv \omega_i L_i / p_i Y_i)$ , employment rate  $v_i (\equiv L_i / N_i)$ , expected rate of price inflation  $\pi_i^e$ , money wage rate  $w_i$ , employed labor in efficiency units  $L_i$ , price level  $p_i$ , gross national output in real terms  $Y_i$ , and labor supply in efficiency units  $N_i$  constants in country  $i$  are labor productivity growth rate  $\alpha_i (\equiv \hat{Y}_i / L_i)$ , growth rate of labor supply  $\beta_i (\equiv \hat{N}_i)$ , and adjustment speed of workers' adaptive expectation  $\theta_i$ ; a hat over a variable is used to symbolize the rate of change of the variable.

The constants and parameters in the model should be determined, and then we have six ordinary differential equations:

$$\frac{du_1}{dt} = 0.5 \left( \frac{0.1}{1 - v_1} + \pi_1^e - 0.5 \right) u_1 + q, \quad (3.2)$$

$$\frac{dv_1}{dt} = 0.1 \left( 1.5(1 - u_1)^5 + 3.5(u_2 - u_1)^3 + 0.5u_1 - 0.875v_1 - 0.1 \right) v_1, \quad (3.3)$$

$$\frac{d\pi_1^e}{dt} = \frac{v_1(0.4\pi_1^e + 0.2) - 0.4\pi_1^e - 0.16}{1 - v_1}, \quad (3.4)$$

$$\frac{du_2}{dt} = 0.5 \left( \frac{0.1}{1 - v_2} + \pi_2^e - 0.5 \right) u_2, \quad (3.5)$$

$$\frac{dv_2}{dt} = 0.1 \left( 1.5(1 - u_2)^5 + 3.5(u_1 - u_2)^3 + 0.5u_2 - 4.2v_2 + 2.56 \right) v_2, \quad (3.6)$$

$$\frac{d\pi_2^e}{dt} = \frac{v_2(0.4\pi_2^e + 0.2) - 0.4\pi_2^e - 0.16}{1 - v_2}, \quad (3.7)$$

where  $q$  is the function of  $t$  and an input of the neural network in the following.

The system (3.2)–(3.7) is very chaotic and has many unstable periodic orbits; see [47]. The time unit of this system is corresponding to the units of the variables. It is worth noting that the time unit should not be extremely small, such as second, minute and hour, for the rapid vibration is not acceptable in real economic systems. Here, we may let the time unit be a quarter, two quarters, or a year.

#### 4. Application to GGC Model between Two Countries

In this section, we will apply MRC to the GGC model between two countries to demonstrate its validity. Our aim is to make the employment rate approximate stable in a high level by controlling the workers' share in the national income. It shows that the control strategy is important for the policy maker. Here, we use the SIMULINK toolbox for SISO system in MATLAB (Version 7.0), which is designed by Hagan for controlling a robot arm [24].

We make the GGC model between two countries (3.2)–(3.7) as the plant of MRC, and a new model as reference model, in which expected inflation rate of the first country is set to

be zero. Also, we modify  $1/(1-v_1)$  in (3.2) to  $0.02/(1-v_1)$  in (4.1) to make sure that  $v_1$  in the reference model can be approximate stable in a high level. The reference model is as follows:

$$\frac{du_1}{dt} = 0.5 \left( \frac{0.02}{1-v_1} - 0.5 \right) u_1 + r, \quad (4.1)$$

$$\frac{dv_1}{dt} = 0.1 \left( 1.5(1-u_1)^5 + 3.5(u_2-u_1)^3 + 0.5u_1 - 0.875v_1 - 0.1 \right) v_1,$$

$$\frac{du_2}{dt} = 0.5 \left( \frac{0.1}{1-v_2} + \pi_2^e - 0.5 \right) u_2, \quad (4.2)$$

$$\frac{dv_2}{dt} = 0.1 \left( 1.5(1-u_2)^5 + 3.5(u_1-u_2)^3 + 0.5u_2 - 4.2v_2 + 2.56 \right) v_2,$$

$$\frac{d\pi_2^e}{dt} = \frac{v_2(0.4\pi_2^e + 0.2) - 0.4\pi_2^e - 0.16}{1-v_2}, \quad (4.3)$$

where  $r$  is the input of reference model.

The effect of MRC is great, if the trajectory of the reference model is very flat (in [21, 41, 42], the authors have all chosen the approximate stable systems to be the reference models). Also, our plant system (3.2)–(3.7) is chaotic as [42] has done. Hence, there is no doubt that this leads to good applicability of our work to use MRC in GGC model and its reference model. Here, the employment rate of the first country in the reference model (4.1)–(4.3) is approximate stable in 0.96, and this is an acceptable value in many countries or economic unions. So we choose (4.1)–(4.3) to be the reference model. Our main purpose is to control the employment rate of the first country in the plant to track along with the one in the reference model. In the following, we will show the main work of this paper.

The system (3.2)–(3.7) is used to generate an input-output data set, which is for the learning purpose in the system identification process. The purpose is to add some control to drive the employment rate of the first country to be approximate stable in a high level. Here, we choose the additional change rate of the workers' share in the national income  $q$  as the control variable (indeed,  $q$  is a set of random values picked in the given range),  $v_p$  the plant output,  $v_N$  the neural network output, and  $v_R$  the reference output. After the suitable sampling of all these variables, we choose  $q = (q_1, \dots, q_N)$  and  $v_P = (v_P^1, \dots, v_P^N)$  as the input and output of the plant (3.2)–(3.7), respectively. (This is the training set.) For a given neural network plant model,  $v_N(p_1)$  is the corresponding neural network output to the input  $q$ , where  $p_1$  contains all the weights involved in the neural network. Then, we have the cost functional for identification:

$$\hat{F}_I(p_1) = e_I^2(p_1), \quad (4.4)$$

where  $e_I(p_1) = |v_P - v_N(p_1)|$ . The system identification is to minimize the functional  $\hat{F}_I(p_1)$  over the parameters  $p_1$ .

In the controller generation process, similar to the random input  $q$ , we should denote the random reference input  $r = (r_1, \dots, r_M)$ . Let  $v_R = (v_R^1, \dots, v_R^M)$  be the reference output of (4.1)–(4.3). Then, we have the cost functional for identification:

$$\hat{F}_R(p_2) = e_R^2(p_2), \quad (4.5)$$



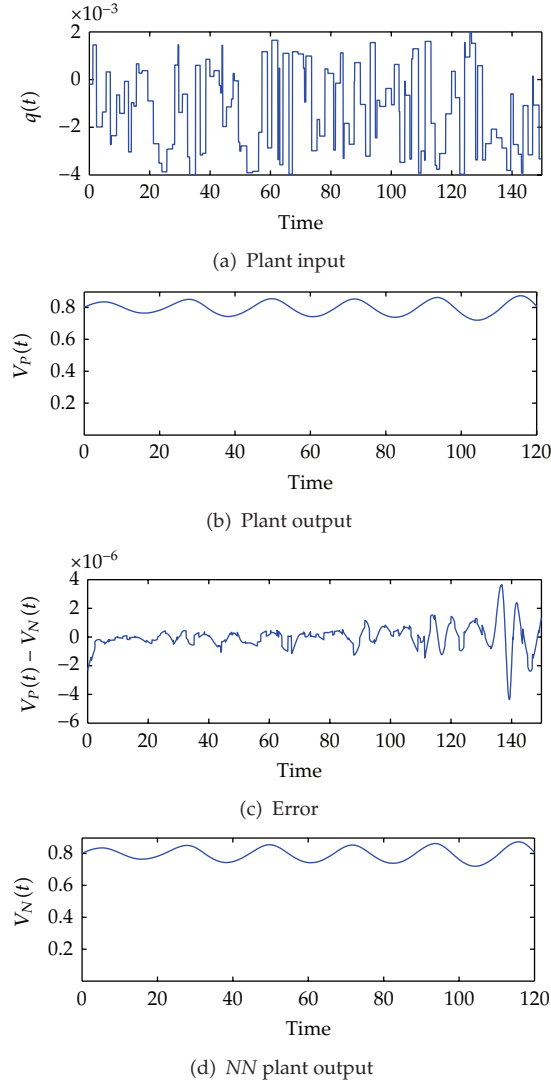

**Figure 5:** Training data for NN MRC of GGC model.

where  $e_R(p_2) = |v_P - v_R(p_2)|$ , and the parameter  $p_2$  is similar to  $p_1$  and contains all the weights in the neural network. The system identification is to minimize the functional  $\hat{F}_R(p_2)$  over the parameters  $p_2$ .

Next, we will train the network of system identification in  $q \in [-0.002, 0.004]$ . See Figure 5. Here, we use the Levenberg-Marquardt algorithm to construct a backpropagation neural network [48]. The built-in function of the algorithm in the SIMULINK is called *trainlm*. We use 300 training epochs for the system identification, and an epoch is just a recurrence of determining and adjusting the weights and functions in the layers through an error-minimizing process. From Figure 5(c), we can observe that the error  $v_1(t)v_{1N}(t)$  is extremely small, and the real plant and the NN plant have almost the same outputs.

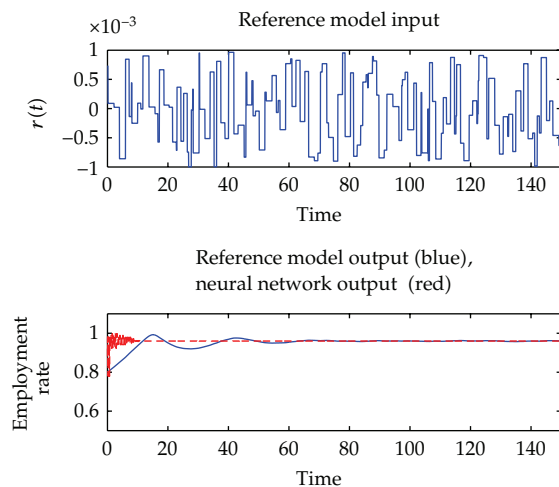

Figure 6: MRC of GGC model with a reference model.

In the following, we will train the controller. It is more difficult to train a controller than to identify a plant, because the network here is recurrent and a dynamic backpropagation algorithm is needed. We will choose 13 segments for the training set and 10 epochs for each segment, and we will train the network of controller generation under the reference model input in  $r \in [-0.001, 0.001]$ . See Figure 6.

Indeed, we have considered the control in (3.2), and the equation turns to be

$$\frac{du_1}{dt} = 0.5 \left( \frac{0.1}{1 - v_1} + \pi_1^e - 0.5 \right) u_1 + q. \quad (4.6)$$

Evidently,  $q$  describes the increasing tendency of public finance expenditure in workers' share, maybe we can call it *additional controller of workers' share*. It will be the gist of the fiscal and monetary policy. See Figure 7.

Now, the whole controlling process can be described as the following. The employment rate of the first country in the plant is widely fluctuant; however, the one in the reference model is approximate stable in long term. To drive the employment rate to follow the tendency of the reference model, one can adjust the workers' share of the national income of the first country slightly. See Figure 8. The plant output is approximate stable at 0.96 in a long term, so our control effect is very remarkable.

Though the two signals have nearly the same tendency, the signal after control is not tracking the signal from the reference model strictly. The reference model we used here is meaningful in economics, because it is obtained by driving the expected inflation rate of the first country to be zero, and has an approximate property in a high level by modifying a coefficient.

Obviously, a model with both simple tendency and suitable economic meaning might be better than our reference model. To make the reference model fit for the practical economic phenomenon, we still insist on choosing the model by driving the expected inflation rate to be zero. Indeed, the policy maker can constitute the fiscal and monetary policies according to the additional controller of workers' share in Figure 7. The results show that we can control

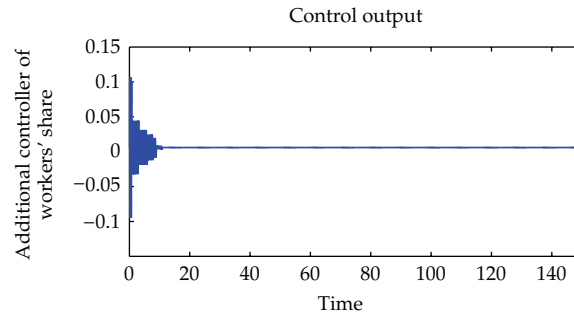

Figure 7: Additional controller of workers' share of the MRC.

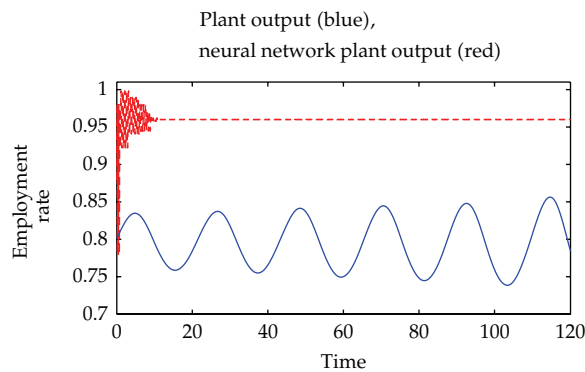

Figure 8: A comparison between original plant output and controlled plant output.

the workers' share in the national income to make the employment rate approximate stable in a high level.

## 5. Conclusion

Model reference control technique has been used to control a complex economic system in this paper. The specific control method in engineering is very helpful to constitute economic policies for a country or an economic union. The simulation results show that one can control the employment rate stable in a high level by adjusting the workers' share in the national income.

## Acknowledgments

P. Zhao expresses sincere thanks to Professor Yong Li for his guidance, Professor Dayou Liu, and Professor Bo Yang for their instructions and many invaluable suggestions. Also, many thanks to the NSFC (Grant no.11071026, 11001100, 11171131, and 11026043) and the Basic Research Program of Jilin University (450060481098). This work is supported in part by the National Basic Research Program of China (973) under Grant 2009CB219301, the National Public Benefit Scientific Research Foundation of China under Grant 201011078, and the National Innovation Research Project for Exploration and Development of Oil Shale under

Grant OSP-02 and OSR-02. The authors gratefully acknowledge the anonymous reviewers for their hard work and good patience.

## References

- [1] M. Aoki, "Control of large-scale dynamic systems by aggregation," *IEEE Transactions on Automatic Control*, vol. AC-13, pp. 246–253, 1968.
- [2] M. Aoki, "On sufficient conditions for optimal stabilization policies," *Review of Economic Studies*, vol. 40, pp. 131–138, 1973.
- [3] K. A. Fox, J. K. Sengupta, and E. Thorbecke, *The Theory of Quantitative Economic Policy with Applications to Economic Growth Stabilization and Planning*, North-Holland, Amsterdam, The Netherlands, 2nd edition, 1973.
- [4] B. M. Friedman, *Methods in Optimization for Economic Stabilization Policy*, North-Holland, Amsterdam, The Netherlands, 1974.
- [5] A. W. Phillips, "Stabilization policy in a closed economy," *Economic Journal*, vol. 64, pp. 290–323, 1950.
- [6] A. W. Phillips, "Stabilisation policy and the time-form of lagged responses," *Economic Journal*, vol. 67, no. 266, pp. 256–277, 1957.
- [7] A. Tustin, *The Mechanism of Economic Systems—An Approach to the Problem of Economic Stabilisation from the Point of View of Control System Engineering*, Harvard University Press, Cambridge, Mass, USA, 1953.
- [8] J. Tinbergen, *On the Theory of Economic Policy*, North-Holland, Amsterdam, The Netherlands, 1952.
- [9] M. Aoki, "On a generalization of Tinbergen's condition in the theory of economic policy to dynamic models," *Review of Economic Studies*, vol. 42, no. 1, pp. 293–296, 1975.
- [10] A. J. Preston and A. R. Pagan, *The Theory of Economic Policy: Statics and Dynamics*, Cambridge University Press, Cambridge, UK, 1982.
- [11] P. D. Joseph and J. T. Tou, "On linear control theory," *Transactions of the AIEE*, vol. 80, pp. 193–196, 1961.
- [12] G. C. Chow, *Analysis and Control of Dynamic Economic Systems*, Wiley, New York, NY, USA, 1975.
- [13] G. C. Chow, *Econometric Analysis by Control Methods*, Wiley, New York, NY, USA, 1981.
- [14] J. Matulka and R. Neck, "OPTCON: an algorithm for the optimal control of nonlinear stochastic models," *Annals of Operations Research*, vol. 37, no. 1–4, pp. 375–401, 1992.
- [15] H. S. Witsenhausen, "A counterexample in stochastic optimum control," *SIAM Journal on Control and Optimization*, vol. 6, pp. 131–147, 1968.
- [16] M. G. Singh, *Decentralized Control*, Elsevier, Amsterdam, The Netherlands, 1981.
- [17] P. Whittle, "Risk sensitivity, a strangely pervasive concept," *Macroeconomic Dynamics*, vol. 6, no. 1, pp. 5–18, 2002.
- [18] M. P. Tucci, "Understanding the difference between robust control and optimal control in a linear discrete-time system with time-varying parameters," *Computational Economics*, vol. 27, no. 4, pp. 533–558, 2006.
- [19] R. J. Tetlow and P. von zur Muehlen, "Robustifying learnability," *Journal of Economic Dynamics and Control*, vol. 33, no. 2, pp. 296–316, 2009.
- [20] L. A. Aguirre, "Model reference control of regular and chaotic dynamics in the Duffing-Ueda oscillator," *IEEE Transactions on Circuits and Systems I*, vol. 41, no. 7, pp. 477–480, 1994.
- [21] A. Ucar, "Model-reference control of chaotic systems," *Chaos, Solitons and Fractals*, vol. 31, no. 3, pp. 712–717, 2007.
- [22] Y. D. Landau, *Adaptive Control: The Model Reference Approach*, CRC Press, New York, NY, USA, 1979.
- [23] H. Adloo, N. Noroozi, and P. Karimaghaee, "Observer-based model reference adaptive control for unknown time-delay chaotic systems with input nonlinearity," *Nonlinear Dynamics*, vol. 67, pp. 1337–1356, 2012.
- [24] M. T. Hagan, H. B. Demuth, and O. De Jesus, "An introduction to the use of neural networks in control systems," *International Journal of Robust and Nonlinear Control*, vol. 12, no. 11, pp. 959–985, 2002.
- [25] R. Kamnik, D. Matko, and T. Bajd, "Application of model reference adaptive control to industrial robot impedance control," *Journal of Intelligent and Robotic Systems*, vol. 22, no. 2, pp. 153–163, 1998.
- [26] N. Hovakimyan, R. Rysdyk, and A. J. Calise, "Dynamic neural networks for output feedback control," in *Proceedings of the 38th IEEE Conference on Decision and Control (CDC '99)*, vol. 2, pp. 1685–1690, December 1999.
- [27] E. N. Johnson and S. K. Kannan, "Adaptive trajectory based control for autonomous helicopters," in *Proceedings of the AIAA Guidance, Navigation, and Control Conference*, August 2002.

- [28] M. D. Johnson, A. J. Cause, and E. N. Johnson, "Evaluation of an adaptive method for launch vehicle flight control," in *Proceedings of the AIAA Guidance, Navigation, and Control Conference*, pp. 1354–1370, August 2004.
- [29] M. D. Johnson, A. J. Cause, and E. N. Johnson, "Further evaluation of an adaptive method for launch vehicle flight control," in *Proceedings of the AIAA Guidance, Navigation, and Control Conference*, pp. 1354–1370, August 2004.
- [30] E. Yamamura, "A study on model reference adaptive control in economic development (I)," *Journal of the Graduate School of Environmental Science*, vol. 6, no. 2, pp. 281–299, 1983.
- [31] E. Yamamura, "A study of model reference adaptive control in economic development (II)," *Journal of the Graduate School of Environmental Science*, vol. 7, no. 1, pp. 1–13, 1984.
- [32] W. Adi, E. Yamamura, and Y. Miyata, "A study on model reference adaptive control in economic development (III): model reference adaptive I-O analysis," *Journal of the Graduate School of Environmental Science*, vol. 9, pp. 27–43, 1986.
- [33] E. Yamamura, "Model reference adaptive control in economic development (IV): discrete polynomial nonlinear system," *Journal of the Graduate School of Environmental Science*, vol. 9, no. 2, pp. 161–172, 1986.
- [34] Y. Miyata and E. Yamamura, "A study on model reference adaptive control in economic development (V): model reference adaptive Turnpike theorem (I)," *Journal of the Graduate School of Environmental Science*, vol. 10, no. 2, pp. 19–35, 1987.
- [35] Y. Miyata and E. Yamamura, "A study on model reference adaptive control in economic development (VI): model reference adaptive Turnpike theorem (II)," *Journal of the Graduate School of Environmental Science*, vol. 10, no. 2, pp. 145–165, 1987.
- [36] Y. Miyata and E. Yamamura, "A study on model reference adaptive control in economic development VII: model reference adaptive processes in Japan's nine regional economies," *Journal of the Graduate School of Environmental Science*, vol. 11, no. 1, pp. 47–79, 1988.
- [37] E. Yamamura and Y. Miyata, "A study on model reference adaptive control in economic development (VIII): model reference adaptive interregional migration in Indonesia," *Journal of the Graduate School of Environmental Science*, vol. 11, no. 2, pp. 141–184, 1988.
- [38] A. B. Asiedu and E. Yamamura, "A study on model reference adaptive control in economic development (IX): model reference adaptive housing model," *Journal of the Graduate School of Environmental Science*, vol. 12, no. 2, pp. 13–28, 1989.
- [39] Y. Miyata and E. Yamamura, "The model reference adaptive system in the dynamic input-output model," *Papers of the Regional Science Association*, vol. 68, no. 1, pp. 57–70, 1990.
- [40] E. Yamamura, "Optimal and reference adaptive processes for the control of regional income disparities," *Papers of the Regional Science Association*, vol. 56, no. 1, pp. 201–213, 1985.
- [41] S.-N. Chow and Y. Li, "Model reference control for SIRS models," *Discrete and Continuous Dynamical Systems A*, vol. 24, no. 3, pp. 675–697, 2009.
- [42] M. Sun, Y. Tao, X. Wang, and L. Tian, "The model reference control for the four-dimensional energy supply-demand system," *Applied Mathematical Modelling*, vol. 35, no. 10, pp. 5165–5172, 2011.
- [43] C. Holt, F. Modigliani, J. F. Muth, and H. A. Simon, *Planning Production, Inventories, and Work Force*, Prentice-Hall, Englewood Cliffs, NJ, USA, 1960.
- [44] B. Sergio and P. Giorgio, *Identification, Adaptation, Learning*, Computer and Systems Sciences, Springer, New York, NY, USA, 1996.
- [45] N. E. Cotter, "The Stone-Weierstrass theorem and its application to neural networks," *IEEE Transactions on Neural Networks*, vol. 1, no. 4, pp. 290–295, 1990.
- [46] R. M. Goodwin, "A growth cycle," in *Socialism, Capitalism and Economic Growth*, C. H. Feinstein, Ed., Cambridge University Press, Cambridge, UK, 1967.
- [47] K. Ishiyama and Y. Saiki, "Unstable periodic orbits and chaotic economic growth," *Chaos, Solitons and Fractals*, vol. 26, no. 1, pp. 33–42, 2005.
- [48] M. Hagan, H. Demuth, and M. Beale, *Neural Network Design*, PWS, Boston, Mass, USA, 1996.



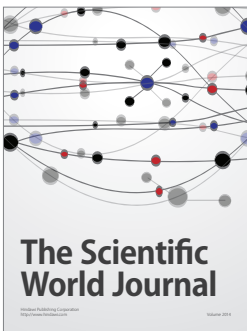

# Hindawi

Submit your manuscripts at  
<http://www.hindawi.com>

