

Research Article

State-PID Feedback for Pole Placement of LTI Systems

Sarawut Sujitjorn and Witchupong Wiboonjaroen

*School of Electrical Engineering, Institute of Engineering, Suranaree University of Technology,
Nakhon Ratchasima 30000, Thailand*

Correspondence should be addressed to Sarawut Sujitjorn, sarawut@sut.ac.th

Received 3 February 2011; Revised 28 March 2011; Accepted 15 June 2011

Academic Editor: J. Rodellar

Copyright © 2011 S. Sujitjorn and W. Wiboonjaroen. This is an open access article distributed under the Creative Commons Attribution License, which permits unrestricted use, distribution, and reproduction in any medium, provided the original work is properly cited.

Pole placement problems are especially important for disturbance rejection and stabilization of dynamical systems and regarded as algebraic inverse eigenvalue problems. In this paper, we propose gain formulae of state feedback through PID-elements to achieve desired pole placement for a delay-free LTI system with single input. Real and complex stable poles can be assigned with the proposed compact gain formulae. Numerical examples show that our proposed gain formulae can be used effectively resulting in very satisfactory responses.

1. Introduction

Pole placement has been an important design method of a linear control system [1–8]. One approach is to use state feedback in which the gain matrix is calculated via Ackermann's formula [4]. Regarding this, the original state model can be transformed into the bidiagonal-Frobenius canonical form to achieve the desired pole placement [9]. Based on the Frobenius form, the gain matrices can be readily computed for SISO and MIMO systems [10–12]. The concept of using state-derivative feedback was introduced in 2003–2004 [13, 14]. One advantage over the conventional state feedback is that it results in smaller gains. In practical control, for example, vibration control, the derivative signal can be derived from an accelerometer output as the concept has been successfully implemented [15, 16]. A linear quadratic regulator to achieve the state-derivative feedback was also developed [17]. Recently, stabilizability and disturbance rejection issues have been investigated for an LTI system with state-derivative vector as its output [18]. The state-derivative feedback is useful for stabilization and rejection of dynamic disturbances not for set-point regulation or tracking control. The approach of state-derivative feedback leads to a possibility of using state-PID feedback.

Consider a delay-free LTI system having single input of the form

$$\mathbf{x}' = \mathbf{A}\mathbf{x} + \mathbf{B}u, \quad \mathbf{x}(t_0) = \mathbf{x}_0, \quad (1.1)$$

where $\mathbf{x} \in \mathbf{R}^n$, $u \in \mathbf{R}$, \mathbf{A} and \mathbf{B} are $(n \times n)$ and $(n \times 1)$ real coefficient matrices, respectively.

The linear system under consideration must possess a complete controllability property. Therefore, the controllability matrix \mathbf{w}_c must have rank- n and can be formed from

$$\mathbf{w}_c = [\mathbf{B} \ \mathbf{A}\mathbf{B} \ \mathbf{A}^2\mathbf{B} \ \cdots \ \mathbf{A}^{n-1}\mathbf{B}]. \quad (1.2)$$

The Frobenius canonical form of the system is

$$\xi' = \begin{bmatrix} 0 & 1 & 0 & \cdots & 0 \\ 0 & 0 & 1 & \cdots & 0 \\ \vdots & \vdots & \ddots & \ddots & \vdots \\ 0 & 0 & 0 & \cdots & 1 \\ -a_0 & -a_1 & \cdots & \cdots & -a_{n-1} \end{bmatrix} \xi + \begin{bmatrix} 0 \\ 0 \\ 0 \\ \vdots \\ 1 \end{bmatrix} u, \quad (1.3)$$

where $\xi = \mathbf{T}\mathbf{x}$, $\mathbf{A}_c = \mathbf{T}\mathbf{A}\mathbf{T}^{-1}$, $\mathbf{B}_c = \mathbf{T}\mathbf{B}$, and $\mathbf{T} = [\mathbf{q}_1 \mathbf{q}_1 \mathbf{A} \cdots \mathbf{q}_1 \mathbf{A}^{n-1}]^T$. The vector $\mathbf{q}_1 = \mathbf{e}_n^T \mathbf{w}_c^{-1}$ in which $\mathbf{e}_n = [0 \ 0 \ \cdots \ 1]^T$. For the state-PID feedback, the control u is of the form

$$u = \mathbf{K}_p \mathbf{x} + \mathbf{K}_I \int \mathbf{x}(\tau) d\tau + \mathbf{K}_d \mathbf{x}', \quad (1.4)$$

where $\mathbf{K}_p, \mathbf{K}_I, \mathbf{K}_d \in \mathbf{R}^n$ are row gain vectors for the P, I, and D feedback elements, respectively. Guo et al. (2006) [21] proposed a pole placement method consisting of 3 separated steps. The pole placement by a state-P feedback is conducted first leading to an intermediate system. Secondly, a state-I feedback is performed; another intermediate system resulted. Finally, the closed-loop system with the desired characteristic polynomial is realized by a state-D feedback incorporated as the final design stage. These steps may be utilized purposefully to design state-P, -PD, and -PI feedback elements. According to this, the control u of the P-feedback is

$$u = \tilde{\mathbf{K}}_F \xi, \quad (1.5)$$

where $\tilde{\mathbf{K}}_F = [\tilde{k}_1 \ \tilde{k}_2 \ \cdots \ \tilde{k}_n]$ to achieve a desired characteristic polynomial

$$\tilde{\Delta}_d(s) = \tilde{\alpha}_0 + \tilde{\alpha}_1 s + \cdots + \tilde{\alpha}_{n-1} s^{n-1} + \tilde{\alpha}_n s^n, \quad \tilde{\alpha}_n = a_n = 1. \quad (1.6)$$

The closed-loop system at this interim stage has its characteristic polynomial

$$\tilde{\Delta}(s) = (a_0 - \tilde{k}_1) + (a_1 - \tilde{k}_2)s + \cdots + (a_{n-1} - \tilde{k}_n)s^{n-1} + s^n. \quad (1.7)$$

Equating (1.6) and (1.7) results in the gain matrix $\tilde{\mathbf{K}}_F$. For the I-feedback, the control u is

$$u = \bar{\mathbf{K}}_F \int_0^t \xi(\tau) d\tau, \quad (1.8)$$

where $\bar{\mathbf{K}}_F = [\bar{k}_1 \ \bar{k}_2 \ \cdots \ \bar{k}_n]$ to achieve a desired characteristic polynomial

$$\bar{\Delta}_d(s) = \bar{\alpha}_0 + \bar{\alpha}_1 s + \cdots + \bar{\alpha}_{n-1} s^{n-1} + \bar{\alpha}_n s^n + \bar{\alpha}_{n+1} s^{n+1}, \quad \bar{\alpha}_{n+1} = 1. \quad (1.9)$$

The second interim system has its closed-loop characteristic polynomial

$$\bar{\Delta}(s) = -\bar{k}_1 + (a_0 - \bar{k}_2)s + \cdots + (a_{n-2} - \bar{k}_n)s^{n-1} + a_{n-1}s^n + s^{n+1}. \quad (1.10)$$

Equating (1.9) and (1.10) leads to the gain matrix $\bar{\mathbf{K}}_F$. For the D-feedback, the control u is

$$u = \hat{\mathbf{K}}_F \xi', \quad (1.11)$$

where $\hat{\mathbf{K}}_F = [\hat{k}_1 \ \hat{k}_2 \ \cdots \ \hat{k}_n]$ to achieve a desired characteristic polynomial

$$\hat{\Delta}_d(s) = \hat{\alpha}_0 + \hat{\alpha}_1 s + \cdots + \hat{\alpha}_{n-1} s^{n-1} + \hat{\alpha}_n s^n. \quad (1.12)$$

Equating (1.12) and the closed-loop characteristic polynomial in (1.13) results in the last set of

$$\hat{\Delta}(s) = a_0 + (a_1 - \hat{k}_1)s + \cdots + (a_{n-1} - \hat{k}_{n-1})s^{n-1} + (1 - \hat{k}_n)s^n, \quad (1.13)$$

gain matrix, $\hat{\mathbf{K}}_F$. This previous method requires three sets of poles to be assigned. Two sets are fictitious, and only the last set is the prescribed characteristic polynomial. In [21], there are no recommendations for selection of these intermediate pole sets. One may attempt arbitrarily chosen poles during the separated design phases. In due course, the calculation procedures are quite awkward. Besides, the paper [21] contains no proof of the proposed theorem.

This paper begins by presenting derivation of the gain matrices for the state-PID feedback in rigorous manner. It also presents the gain matrices for the state-PI and -PD feedback cases. Section 3 presents the analysis of disturbance rejection property of the proposed method. Such complete treatment has not appeared elsewhere before. Three numerical examples are shown in Section 4 to illustrate the effectiveness of our proposed gain formulae in comparison with the use of Ackermann's formula [4, 19] and the methods

by Guo et al. [21] and Kuo [20], respectively. Moreover, we show by simulations in the example shown in Section 4.3 that using the method [21] can result in very large controller gains although the final pole sets remain unchanged. Conclusion follows in Section 5.

2. The PID Gain Matrices

Without loss of generality, the single-input LTI system (1.1) is assumed to be completely controllable, and \mathbf{B} is of full column rank. The next proposition is the main result presenting the state-PID feedback gain matrices. Note that due to the integral element, one additional closed-loop pole is needed. This imposes a condition for derivation of the gain matrices and results in an increase in the order of the system by one.

Proposition 2.1. *The system (1.1) with its Frobenius form of (1.3) is subject to the control input $u = \mathbf{K}_p \mathbf{x} + \mathbf{K}_I \int \mathbf{x}(\tau) d\tau + \mathbf{K}_d \mathbf{x}'$ or $u = \tilde{\mathbf{K}}_F \boldsymbol{\xi} + \bar{\mathbf{K}}_F \int_0^t \boldsymbol{\xi}(\tau) d\tau + \hat{\mathbf{K}}_F \boldsymbol{\xi}'$ in which $[\mathbf{K}_p, \mathbf{K}_I, \mathbf{K}_d] = [\tilde{\mathbf{K}}_F, \bar{\mathbf{K}}_F, \hat{\mathbf{K}}_F] \mathbf{T}$. There exist the following gain matrices to achieve a desired characteristic polynomial $\Delta_d(s) = \alpha_0 + \alpha_1 s + \dots + \alpha_{n-1} s^{n-1} + \alpha_n s^n + \alpha_{n+1} s^{n+1}$:*

(i) for $n = 2$,

$$\begin{aligned} \mathbf{K}_p &= [a_0 \ a_1] \mathbf{T}, \\ \mathbf{K}_I &= [-\alpha_0 \ -\alpha_1] \mathbf{T}, \\ \mathbf{K}_d &= [-\alpha_2 \ 0] \mathbf{T}, \end{aligned} \tag{2.1}$$

(ii) for $n \geq 3$,

$$\begin{aligned} \mathbf{K}_p &= [a_0 \ : \ a_1 \ : \ \dots \ : \ \dots \ : \ a_{n-1}] \mathbf{T}, \\ \mathbf{K}_I &= [-\alpha_0 \ : \ -\alpha_1 \ : \ -2\alpha_2 \ : \ \dots \ : \ -2\alpha_{n-1}] \mathbf{T}, \\ \mathbf{K}_d &= [\alpha_2 \ : \ \dots \ : \ \alpha_{n-1} \ : \ -\alpha_n \ : \ 0] \mathbf{T}. \end{aligned} \tag{2.2}$$

Proof. The characteristic polynomial of the closed-loop system can be expressed as

$$\Delta_{\text{PID}}(s) = \det \left[s(\mathbf{I} - \mathbf{B}_c \hat{\mathbf{K}}_F) - \mathbf{A}_c - \mathbf{B}_c \tilde{\mathbf{K}}_F - \frac{\mathbf{B}_c \bar{\mathbf{K}}_F}{s} \right] = 0, \tag{2.3}$$

where \mathbf{I} is an $n \times n$ identity matrix,

$$s(\mathbf{I} - \mathbf{B}_c \hat{\mathbf{K}}_F) - \mathbf{A}_c - \mathbf{B}_c \tilde{\mathbf{K}}_F = \begin{bmatrix} s & -1 & 0 & \cdots & 0 \\ 0 & s & -1 & \cdots & 0 \\ 0 & 0 & s & \ddots & \vdots \\ \vdots & \vdots & \vdots & \ddots & -1 \\ a_0 - \hat{k}_1 s - \tilde{k}_1 & a_1 - \hat{k}_2 s - \tilde{k}_2 & \cdots & \cdots & s + a_{n-1} - \hat{k}_n s - \tilde{k}_n \end{bmatrix}, \quad (2.4)$$

$$\frac{\mathbf{B}_c \bar{\mathbf{K}}_F}{s} = \begin{bmatrix} 0 & 0 & 0 & \cdots & 0 \\ 0 & 0 & 0 & \cdots & 0 \\ \vdots & \vdots & \vdots & \ddots & \vdots \\ 0 & 0 & 0 & \cdots & 0 \\ \frac{\bar{k}_1}{s} & \frac{\bar{k}_2}{s} & \cdots & \cdots & \frac{\bar{k}_n}{s} \end{bmatrix},$$

that is,

$$\Delta_{\text{PID}}(s) = \begin{vmatrix} s & -1 & 0 & \cdots & 0 \\ 0 & s & -1 & \cdots & 0 \\ 0 & 0 & s & \ddots & \vdots \\ \vdots & \vdots & \vdots & \ddots & -1 \\ a_0 - \hat{k}_1 s - \tilde{k}_1 - \frac{\bar{k}_1}{s} & a_1 - \hat{k}_2 s - \tilde{k}_2 - \frac{\bar{k}_2}{s} & \cdots & \cdots & s + a_{n-1} - \hat{k}_n s - \tilde{k}_n - \frac{\bar{k}_n}{s} \end{vmatrix} \quad (2.5)$$

or

$$\begin{aligned} \Delta_{\text{PID}}(s) = & -\bar{k}_1 + (a_0 - \tilde{k}_1 - \bar{k}_2)s + (a_1 - \tilde{k}_2 - \hat{k}_1 - \bar{k}_3)s^2 + \cdots + (a_{n-2} - \tilde{k}_{n-1} - \hat{k}_{n-2} - \bar{k}_n)s^{n-1} \\ & + (a_{n-1} - \tilde{k}_n - \hat{k}_{n-1})s^n + (1 - \hat{k}_n)s^{n+1}. \end{aligned} \quad (2.6)$$

It can be observed that the order of the closed-loop system is increased by 1 due to the integral element. By equating (2.6) with the desired characteristic polynomial, the following relations can be obtained for an n -order system:

$$\begin{aligned}
-\bar{k}_1 &= \alpha_0, \\
a_0 - \tilde{k}_1 - \bar{k}_2 &= \alpha_1, \\
a_1 - \tilde{k}_2 - \hat{k}_1 - \bar{k}_3 &= \alpha_2, \\
&\vdots \\
a_{n-2} - \tilde{k}_{n-1} - \hat{k}_{n-2} - \bar{k}_n &= \alpha_{n-1}, \\
a_{n-1} - \tilde{k}_n - \hat{k}_{n-1} &= \alpha_n, \\
1 - \hat{k}_n &= \alpha_{n+1}.
\end{aligned} \tag{2.7}$$

Therefore, a desired pole placement can be achieved via the state-PID feedback using the gain matrices in (2.1) and (2.2).

This completes the proof. \square

The following are 2 immediate consequences of Proposition 2.1.

Corollary 2.2. *The system (1.1) with its Frobenius form of (1.3) is subject to the control input $u = \mathbf{K}_p \mathbf{x} + \mathbf{K}_I \int_0^t \mathbf{x}(\tau) d\tau$ or $u = \tilde{\mathbf{K}}_F \boldsymbol{\xi} + \bar{\mathbf{K}}_F \int_0^t \boldsymbol{\xi}(\tau) d\tau$ in which $[\mathbf{K}_p, \mathbf{K}_I] = [\tilde{\mathbf{K}}_F, \bar{\mathbf{K}}_F] \mathbf{T}$. There exist the following gain matrices to achieve a desired characteristic polynomial $\Delta_d(s) = \alpha_0 + \alpha_1 s + \dots + \alpha_{n-1} s^{n-1} + \alpha_n s^n + \alpha_{n+1} s^{n+1}$:*

$$\begin{aligned}
\mathbf{K}_p &= [a_0 \ : \ a_1 \ : \ a_2 \ : \ \dots \ : \ a_{n-1} - \alpha_n] \mathbf{T}, \\
\mathbf{K}_I &= [-\alpha_0 \ : \ -\alpha_1 \ : \ -\alpha_2 \ : \ \dots \ : \ -\alpha_{n-1}] \mathbf{T}.
\end{aligned} \tag{2.8}$$

Corollary 2.3. *The system (1.1) with its Frobenius form of (1.3) is subject to the control input $u = \mathbf{K}_p \mathbf{x} + \mathbf{K}_d \mathbf{x}'$ or $u = \tilde{\mathbf{K}}_F \boldsymbol{\xi} + \hat{\mathbf{K}}_F \boldsymbol{\xi}'$ in which $[\mathbf{K}_p, \mathbf{K}_d] = [\tilde{\mathbf{K}}_F, \hat{\mathbf{K}}_F] \mathbf{T}$. There exist the following gain matrices to achieve a desired characteristic polynomial $\Delta_d(s) = \alpha_0 + \alpha_1 s + \dots + \alpha_{n-1} s^{n-1} + \alpha_n s^n$:*

$$\begin{aligned}
\mathbf{K}_p &= [a_0 - \alpha_0 \ : \ -\alpha_1 \ : \ -\alpha_2 \ : \ \dots \ : \ -\alpha_{n-1}] \mathbf{T}, \\
\mathbf{K}_d &= [a_1 \ : \ a_2 \ : \ \dots \ : \ a_{n-1} \ : \ 0] \mathbf{T}.
\end{aligned} \tag{2.9}$$

Note that with the state-PD feedback, no additional pole is needed for the design. Therefore, the order of the system remains unchanged.

The design procedures are as follows:

- (1) calculate the transformation matrix for an n -order LTI plant using $\mathbf{T} = [\mathbf{q}_1 \mathbf{q}_1 \mathbf{A} \cdots \mathbf{q}_1 \mathbf{A}^{n-1}]^T$ where $\mathbf{q}_1 = \mathbf{e}_n^T \mathbf{w}_c^{-1}$, $\mathbf{e}_n = [0 \ 0 \ \cdots \ 1]^T$, and $\mathbf{w}_c = [\mathbf{B} \ \mathbf{A}\mathbf{B} \ \mathbf{A}^2\mathbf{B} \ \cdots \ \mathbf{A}^{n-1}\mathbf{B}]$,
- (2) calculate the matrices \mathbf{A}_c and \mathbf{B}_c using $\mathbf{A}_c = \mathbf{T}\mathbf{A}\mathbf{T}^{-1}$ and $\mathbf{B}_c = \mathbf{T}\mathbf{B}$ for the Frobenius form of (1.3),
- (3) assign the closed-loop pole locations of an n -order:
 - (i) for state-PID feedback, add one negative real pole having a fast time-constant (i.e., a negative real pole with a large magnitude),
 - (ii) for state-PI feedback, add one negative real pole having a fast time constant,
 - (iii) for state-PD feedback, no additional pole is needed,
- (4) determine the prescribed characteristic polynomial $\Delta_d(s)$ having the order of n or $n + 1$ corresponding to step 3,
- (5) calculate the gain matrices:
 - (i) for state-PID feedback, use (2.1) or (2.2),
 - (ii) for state-PI feedback, use (2.8),
 - (iii) for state-PD feedback, use (2.9).

3. Disturbance Rejection

Disturbance rejection is an important property of the proposed state-PID feedback. This section provides the analysis of such property. There are three propositions, one of which has been proposed by [18] and denoted as proposition 3.1 for state-D feedback. The other propositions denoted as Propositions 3.2 and 3.3 are newly developed to confirm the disturbance rejection property accomplished by the state-P and -I feedback components, respectively.

Proposition 3.1. Consider the plant described by

$$\mathbf{x}' = \mathbf{A}\mathbf{x} + \mathbf{B}(\mathbf{u} + \varepsilon), \quad (3.1)$$

where $\varepsilon \in \mathbf{R}$, ε is an unknown but constant disturbance, and the state-D controller

$$\mathbf{u} = -\mathbf{K}_d \mathbf{x}', \quad \det(\mathbf{I} + \mathbf{B}\mathbf{K}_d) \neq 0. \quad (3.2)$$

Suppose that $\det(\mathbf{A}) \neq 0$, and the equilibrium point $\mathbf{x}_e = -\mathbf{A}^{-1}\mathbf{B}\varepsilon$ of the controller system (3.1) and (3.2) is globally asymptotically stable, then $\mathbf{x}(\infty)$ is independent of the controller gain \mathbf{K}_d and is given by

$$\mathbf{x}(\infty) = \lim_{t \rightarrow \infty} \mathbf{x}(t) = -\mathbf{A}^{-1}\mathbf{B}\varepsilon. \quad (3.3)$$

Proof. (see in [18], Lemma 3.2) An immediate conclusion from this proposition according to (3.3) is that the state-D feedback cannot attenuate the influence of ε in $\mathbf{x}(\infty)$ in controlled systems because (3.3) is independent of the state-D matrix \mathbf{K}_d . \square

Proposition 3.2. Consider the plant, with input u in (3.1), and the state-P controller

$$u = -\mathbf{K}_p \mathbf{x}. \quad (3.4)$$

Suppose that the controller system (3.1) and (3.4) is globally asymptotically stable, then $\mathbf{x}(\infty)$ is dependent on the controller gain \mathbf{K}_p and is given by

$$\mathbf{x}(\infty) = \lim_{t \rightarrow \infty} \mathbf{x}(t) = -(\mathbf{A} - \mathbf{B}\mathbf{K}_p)^{-1} \mathbf{B}\varepsilon. \quad (3.5)$$

Proof. From (3.1) and (3.4), note that

$$\begin{aligned} \mathbf{x}' &= \mathbf{A}\mathbf{x} + \mathbf{B}(-\mathbf{K}_p \mathbf{x} + \varepsilon), \\ \mathbf{x}' &= (\mathbf{A} - \mathbf{B}\mathbf{K}_p)\mathbf{x} + \mathbf{B}\varepsilon. \end{aligned} \quad (3.6)$$

Applying the Laplace transform to (3.6), observe that

$$\begin{aligned} s\mathbf{X}(s) - \mathbf{x}(0) &= (\mathbf{A} - \mathbf{B}\mathbf{K}_p)\mathbf{X}(s) + \mathbf{B}\varepsilon s^{-1}, \\ (s\mathbf{I} - (\mathbf{A} - \mathbf{B}\mathbf{K}_p))\mathbf{X}(s) &= \mathbf{B}\varepsilon s^{-1} + \mathbf{x}(0), \\ \mathbf{X}(s) &= (s\mathbf{I} - (\mathbf{A} - \mathbf{B}\mathbf{K}_p))^{-1} (\mathbf{B}\varepsilon s^{-1} + \mathbf{x}(0)). \end{aligned} \quad (3.7)$$

Thus,

$$\begin{aligned} \mathbf{x}(\infty) &= \lim_{s \rightarrow 0} s\mathbf{X}(s) = \lim_{s \rightarrow 0} s(s\mathbf{I} - (\mathbf{A} - \mathbf{B}\mathbf{K}_p))^{-1} \mathbf{B}\varepsilon s^{-1} \\ &= -(\mathbf{A} - \mathbf{B}\mathbf{K}_p)^{-1} \mathbf{B}\varepsilon. \end{aligned} \quad (3.8)$$

This completes the proof. \square

From Proposition 3.2, it can be concluded according to (3.8) that the state-P feedback can attenuate the influence of ε in $\mathbf{x}(\infty)$ in controlled systems because (3.8) is dependent on the state-P matrix \mathbf{K}_p .

Proposition 3.3. Consider the plant, with input u in (3.1), and the state-I controller

$$u = -\mathbf{K}_I \int \mathbf{x}(t) dt. \quad (3.9)$$

Suppose that the controller system (3.1) and (3.9) is globally asymptotically stable, and the condition of nonzero \mathbf{K}_I holds, then $\mathbf{x}(\infty)$ is dependent on the controller gain \mathbf{K}_I and is given by

$$\mathbf{x}(\infty) = \lim_{t \rightarrow \infty} \mathbf{x}(t) = 0. \quad (3.10)$$

Proof. From (3.1) and (3.9), note that

$$\begin{aligned} \mathbf{x}' &= \mathbf{A}\mathbf{x} + \mathbf{B} \left(-\mathbf{K}_I \int \mathbf{x}(t) dt + \varepsilon \right), \\ \mathbf{x}' &= \mathbf{A}\mathbf{x} - \mathbf{B}\mathbf{K}_I \int \mathbf{x}(t) dt + \mathbf{B}\varepsilon. \end{aligned} \quad (3.11)$$

Applying the Laplace transform to (3.11), observe that

$$\begin{aligned} s\mathbf{X}(s) - \mathbf{x}(0) &= \mathbf{A}\mathbf{X}(s) - \mathbf{B}\mathbf{K}_I \frac{\mathbf{X}(s)}{s} + \mathbf{B}\varepsilon s^{-1}, \\ \left(s\mathbf{I} + \frac{\mathbf{B}\mathbf{K}_I}{s} - \mathbf{A} \right) \mathbf{X}(s) &= \mathbf{B}\varepsilon s^{-1} + \mathbf{x}(0), \\ \frac{\mathbf{X}(s)}{s} &= \left(s^2\mathbf{I} + \mathbf{B}\mathbf{K}_I - \mathbf{A}s \right)^{-1} \left(\mathbf{B}\varepsilon s^{-1} + \mathbf{x}(0) \right), \\ \mathbf{X}(s) &= s \left(s^2\mathbf{I} + \mathbf{B}\mathbf{K}_I - \mathbf{A}s \right)^{-1} \left(\mathbf{B}\varepsilon s^{-1} + \mathbf{x}(0) \right). \end{aligned} \quad (3.12)$$

Thus,

$$\mathbf{x}(\infty) = \lim_{s \rightarrow 0} s\mathbf{X}(s) = \lim_{s \rightarrow 0} s \left(s \left(s^2\mathbf{I} + \mathbf{B}\mathbf{K}_I - \mathbf{A}s \right)^{-1} \mathbf{B}\varepsilon s^{-1} \right) = 0. \quad (3.13)$$

This completes the proof. \square

An immediate conclusion from Proposition 3.3 is that with the state-I feedback a complete rejection of disturbance in controlled systems can be achieved due to (3.13).

4. Illustrative Examples

Three illustrative examples are presented with focusing on stabilization and disturbance rejection issues. Results are compared with those designed by the previous methods including Ackermann's formula [4, 19], Guo et al. [21], and Kuo [20], respectively.

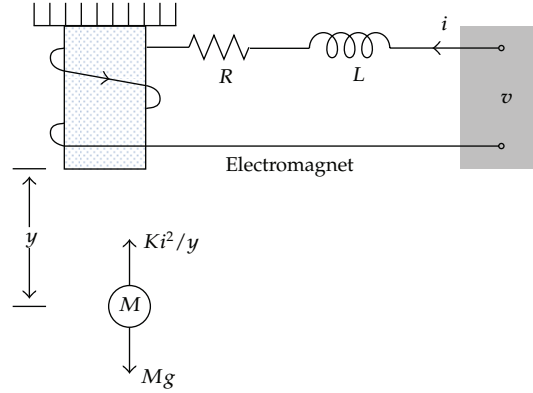

Figure 1: Magnetic ball suspension.

4.1. Magnetic Ball Suspension

The magnetic ball suspension system [20] represented by the diagram in Figure 1 is adopted as the first example. This 3rd-order system is described by

$$\mathbf{x}' = \begin{bmatrix} 0 & 1 & 0 \\ 980 & 0 & -2.8 \\ 0 & 0 & -100 \end{bmatrix} \mathbf{x} + \begin{bmatrix} 0 \\ 0 \\ 100 \end{bmatrix} u, \quad (4.1)$$

where $x_1 = y$, $x_2 = y'$, and $x_3 = i$. The system is originally unstable with its poles at ± 31.3050 and -100 . It is desirable to have the closed-loop poles at $-10 \pm j10$, -50 , and -1000 such that the characteristic polynomial is $\Delta_d(s) = s^4 + 1070s^3 + 71200s^2 + 1210000s + 10000000$. The Frobenius canonical form is

$$\boldsymbol{\xi}' = \begin{bmatrix} 0 & 1 & 0 \\ 0 & 0 & 1 \\ 98000 & 980 & -100 \end{bmatrix} \boldsymbol{\xi} + \begin{bmatrix} 0 \\ 0 \\ 1 \end{bmatrix} u. \quad (4.2)$$

The obtained gain matrices are $\mathbf{K}_p = [0 \ 3.5000 \ 1]$, $\mathbf{K}_I = 10^3 \cdot [534.1140 \ 4.3214 \ -1.4240]$, and $\mathbf{K}_d = [-254.2857 \ 3.8214 \ 0]$.

The gain matrix due to Ackermann's formula is $\mathbf{K} = [-280 \ -7.7857 \ -0.3000]$. Figure 2 shows the responses and the control input according to the proposed method in which the initial conditions are $\mathbf{x}(t_0) = [0.005 \ 0 \ 0]^T$, and the states are disturbed by 1 unit at the time $t = 1$ s. It can be observed that using the proposed method the states possess very good transient responses, the disturbances are completely dampened out, and the control input is reasonable. With the conventional pole placement method, some states contain a large amount of steady-state errors due to disturbance as depicted in Figure 3.

By applying the method [21] to achieve the same closed-loop poles, the design requires the following fictitious sets of poles: $\{-1, -2, -4\}$ and $\{-5, -6, -10\}$. As a result, the gain matrices are $\mathbf{K}_p = [24.5286 \ 3.55 \ 0.93]$, $\mathbf{K}_I = [-208.6697 \ 3.2156 \ 0.6982]$, and $\mathbf{K}_d = [-3.4432 \ -0.023 \ 0.0097]$ with which a combined state-PID feedback controller is derived. The two

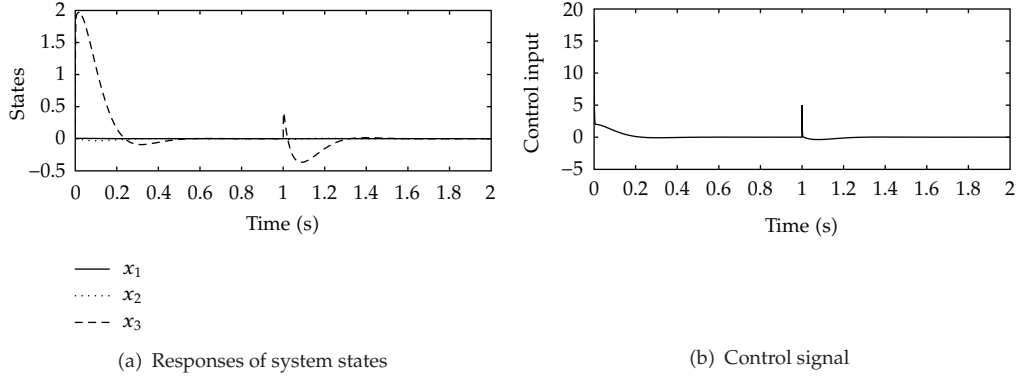

Figure 2: Responses of system states with the proposed state-PID feedback.

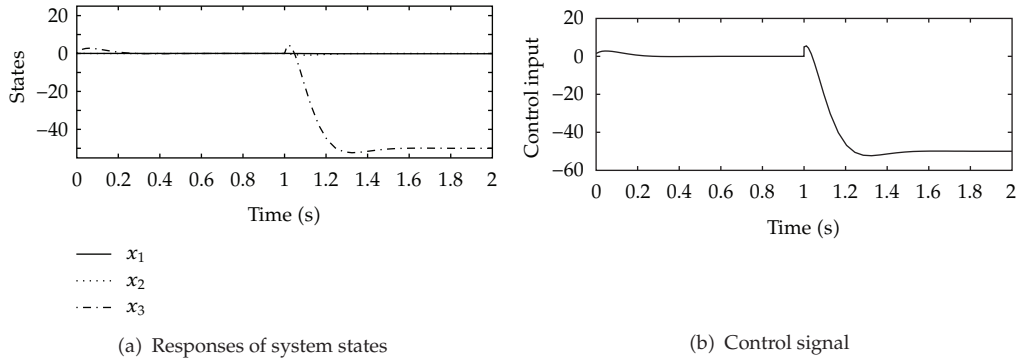

Figure 3: Responses of system states with the conventional state feedback [4, 19].

intermediate systems denoted as Σ_{Int}^1 and Σ_{Int}^2 are given in Frobenius canonical forms as follows:

$$\Sigma_{\text{Int}}^1 = \mathbf{z}' = \begin{bmatrix} 0 & 1 & 0 \\ 0 & 0 & 1 \\ -8 & -14 & -7 \end{bmatrix} \mathbf{z} + \begin{bmatrix} 0 \\ 0 \\ 1 \end{bmatrix} u, \quad u = \widehat{\mathbf{K}}_F \mathbf{z}', \quad (4.3)$$

$$\Sigma_{\text{Int}}^2 = \mathbf{z}' = \begin{bmatrix} 0 & 1 & 0 \\ 0 & 0 & 1 \\ -299.6255 & -139.8240 & -20.9738 \end{bmatrix} \mathbf{z} + \begin{bmatrix} 0 \\ 0 \\ 1 \end{bmatrix} u, \quad u = \overline{\mathbf{K}}_F \int_0^t \mathbf{z}(\tau) d\tau,$$

where $\mathbf{z} = \mathbf{T}\mathbf{x}$. Under the same simulation situations previously described, similar state responses to those in Figure 2 are achieved due to the closed-loop poles located at the same locations $-10 \pm 10j$, -50 . Notice that some of the gains designed by the proposed method are somewhat larger but in reasonable ranges for implementation using either analog or digital technology. The proportional gains of the proposed method are smaller than those obtained using the method [21]. This means that the proposed controller draws less energy to achieve its control action.

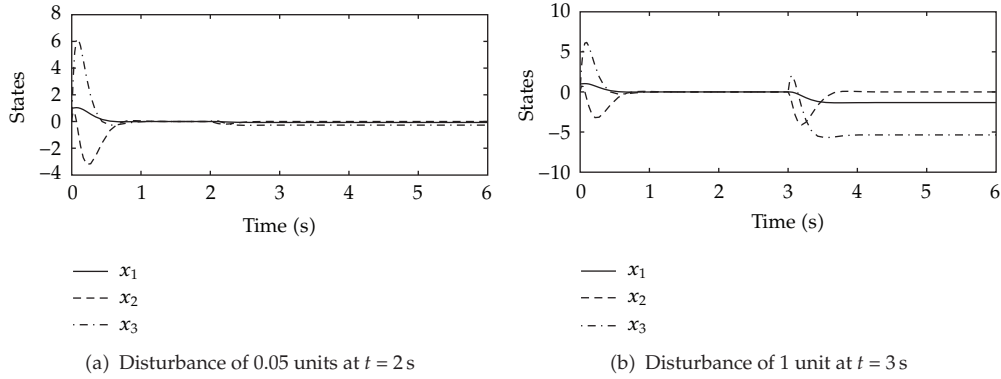

Figure 4: Responses of system states with the method in [20].

Based on the method [20], the gains $\mathbf{K} = [-2.038 \quad -0.2278 \quad -0.68]$ can be obtained to place the closed-loop poles at $-6 \pm 4.9j, -20$ with the desired characteristic polynomial of $\Delta_d(s) = s^3 + 32s^2 + 300s + 1200$. Hence, (4.4) describes the closed-loop system

$$\mathbf{x}' = \begin{bmatrix} 0 & 1 & 0 \\ 64.4 & 0 & -16 \\ 0 & 0 & -100 \end{bmatrix} \mathbf{x} + \begin{bmatrix} 0 \\ 0 \\ 100 \end{bmatrix} u. \quad (4.4)$$

Figure 4 shows the state responses having the initial conditions $\mathbf{x}(t_0) = [1 \ 0 \ 0]^T$, and the states are disturbed by 0.05 and 1 unit at the time $t = 2$ and 3 s. Noticeably, a large amount of steady-state errors in some states due to the disturbances still remain.

4.2. Inverted Pendulum

The inverted pendulum system in [19] is adopted as the second example and represented by the diagram in Figure 5. Its state model is expressed by

$$\mathbf{x}' = \begin{bmatrix} 0 & 1 & 0 & 0 \\ 20.601 & 0 & 0 & 0 \\ 0 & 0 & 0 & 1 \\ -0.4905 & 0 & 0 & 0 \end{bmatrix} \mathbf{x} + \begin{bmatrix} 0 \\ -1 \\ 0 \\ 0.5 \end{bmatrix} u, \quad (4.5)$$

where $x_1 = \theta$, $x_2 = \theta'$, $x_3 = x$, and $x_4 = x'$. With its poles at 0, 0 and ± 4.5388 , the system is inherently unstable. It is desirable to place the closed-loop poles at $-2 \pm 3.464j, -10, -10$, and -100 such that the characteristic polynomial is

$$\Delta_d(s) = s^5 + 124s^4 + 2.595999 \times 10^3 s^3 + 2.0319915 \times 10^4 s^2 + 7.359852 \times 10^4 s + 1.5999256 \times 10^5. \quad (4.6)$$

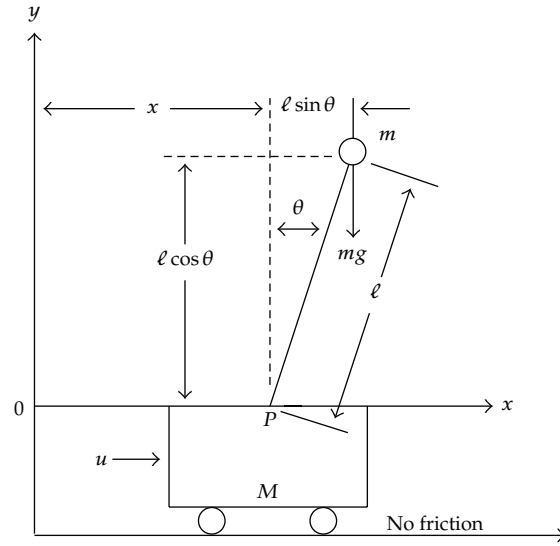

Figure 5: Inverted pendulum.

The Frobenius canonical form is

$$\dot{\xi}' = \begin{bmatrix} 0 & 1 & 0 & 0 \\ 0 & 0 & 1 & 0 \\ 0 & 0 & 0 & 1 \\ 0 & 0 & 20.601 & 0 \end{bmatrix} \xi + \begin{bmatrix} 0 \\ 0 \\ 0 \\ 1 \end{bmatrix} u. \tag{4.7}$$

With the proposed state-PID feedback, the gain matrices are $\mathbf{K}_p = [-20.601 \ 0 \ 0 \ 0]$, $\mathbf{K}_I = [7123.1490 \ 1490.2386 \ 1956.3781 \ 1043.4560]$, and $\mathbf{K}_d = [-120.6720 \ -24.6841 \ -313.0368 \ -49.3195]$.

The gain matrix due to the Ackermann's formula is $\mathbf{K} = [-298.1504 \ -60.6972 \ -163.0989 \ -73.3945]$. Figures 6 and 7 show the responses and the control inputs in which the initial conditions are $x(t_0) = [0.1 \ 0 \ 0 \ 0]^T$, and the states are disturbed by 1 unit at the time $t = 4$ s. These comparative results show a similarity to those of the first example. Very good transient responses with zero steady-state errors are achieved by the proposed method. With the method [21] to achieve the same closed-loop poles, it requires two fictitious pole sets designated as $\{-1, -2, -4, -5\}$ and $\{-5, -6, -10, -11\}$. The following feedback gains are obtained, respectively, as $\mathbf{K}_p = [30.4377 \ 15.9755 \ 4.0775 \ 7.9511]$, $\mathbf{K}_I = [-1562.4506 \ -478.4985 \ 163.0989 \ -262.9969]$, and $\mathbf{K}_d = [-14.4536 \ -1.1561 \ -5.6815 \ -0.3365]$ with which a combined state-PID feedback controller is derived. During the design process, the two

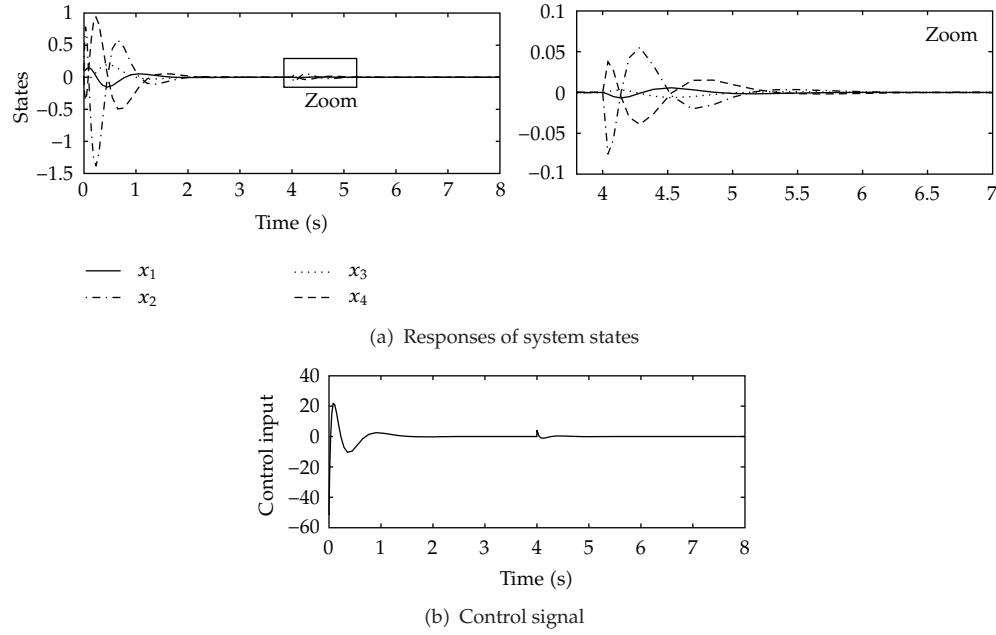

Figure 6: Responses of system states with the proposed method.

intermediate systems Σ_{Int}^1 and Σ_{Int}^2 are calculated and expressed in Frobenius canonical forms as follows:

$$\Sigma_{\text{Int}}^1 = \mathbf{z}' = \begin{bmatrix} 0 & 1 & 0 & 0 \\ 0 & 0 & 1 & 0 \\ 0 & 0 & 0 & 1 \\ -40 & -78 & -7.798 & -12 \end{bmatrix} \mathbf{z} + \begin{bmatrix} 0 \\ 0 \\ 0 \\ 1 \end{bmatrix} u, \quad u = \widehat{\mathbf{K}}_F \mathbf{z}', \quad (4.8)$$

$$\Sigma_{\text{Int}}^2 = \mathbf{z}' = \begin{bmatrix} 0 & 1 & 0 & 0 \\ 0 & 0 & 1 & 0 \\ 0 & 0 & 0 & 1 \\ -3300 & -1840 & -371 & -32 \end{bmatrix} \mathbf{z} + \begin{bmatrix} 0 \\ 0 \\ 0 \\ 1 \end{bmatrix} u, \quad u = \overline{\mathbf{K}}_F \int_0^t \mathbf{z}(\tau) d\tau.$$

Under the same simulation situations, similar responses to those in Figure 6 are achieved because the system possesses the same closed-loop pole locations. As a result, the proposed method gives small proportional gains meaning that the proposed controller draws less energy in comparison with that of the method [21]. The magnitude of the integral and the derivative gains are in reasonable ranges for implementation.

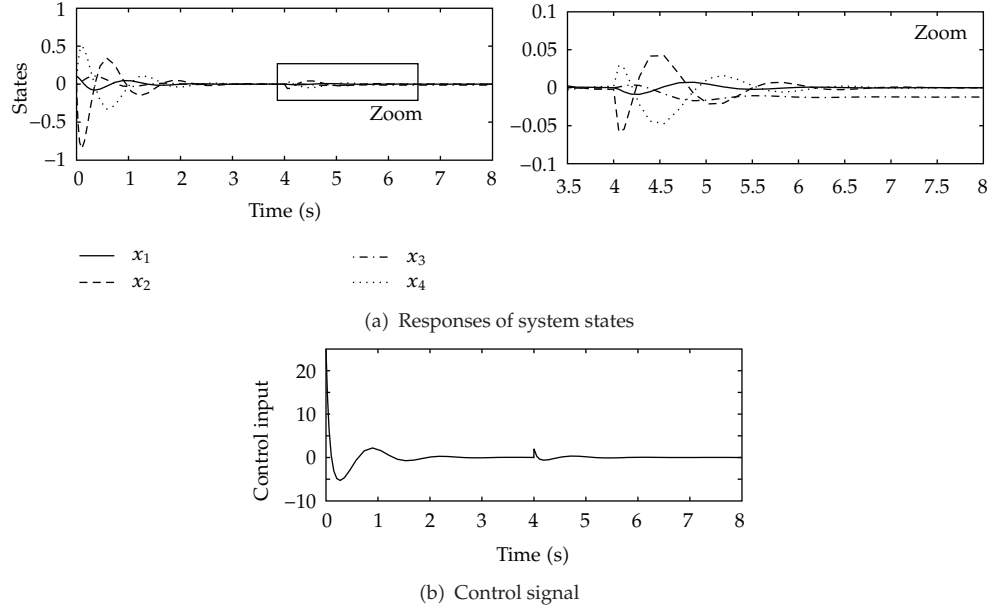

Figure 7: Responses of system states with the conventional method [4, 19].

4.3. Mechanical Vibration

The mechanical vibration system in [14] is adopted as the third example. The diagram in Figure 8 represents the system, which is described by

$$\mathbf{x}' = \begin{bmatrix} 0 & 0 & 1 & 0 \\ 0 & 0 & 0 & 1 \\ -3960 & 360 & -1.2 & 0.5 \\ 3600 & -3600 & 5 & -5 \end{bmatrix} \mathbf{x} + \begin{bmatrix} 0 \\ 0 \\ -0.01 \\ 0.1 \end{bmatrix} u, \quad (4.9)$$

where $x_1 = x_1$, $x_2 = x_2$, $x_3 = x_1'$, and $x_4 = x_2'$. The open-loop poles of the system are $-2.1835 \pm 70.1294j$ and $-0.9165 \pm 51.3006j$. It is desirable to have the closed-loop poles at $-5 \pm 65j$, $-10 \pm 55j$, and -1000 such that the characteristic polynomial is $\Delta_d(s) = s^5 + 1030s^4 + 37575s^3 + 7691250s^2 + 129531250s + 13281.2500 \times 10^6$. The Frobenius canonical form is

$$\xi' = \begin{bmatrix} 0 & 1 & 0 & 0 \\ 0 & 0 & 1 & 0 \\ 0 & 0 & 0 & 1 \\ -1.2960 \times 10^7 & -20520 & -7563.5000 & -6.2000 \end{bmatrix} \xi + \begin{bmatrix} 0 \\ 0 \\ 0 \\ 1 \end{bmatrix} u. \quad (4.10)$$

With the proposed pole placement method, the obtained gain matrices are $\mathbf{K}_p = 10^3 \cdot [-396 \ 36 \ -0.1200 \ 0.0500]$, $\mathbf{K}_I = 10^6 \cdot [1166.857940 \ -36.892361 \ 3.988644 \ -0.352635]$, and $\mathbf{K}_d = 10^3 \cdot [317.3474 \ 21.3646 \ 1.0022 \ 0.1002]$. The gain matrix due to the Ackermann's formula is

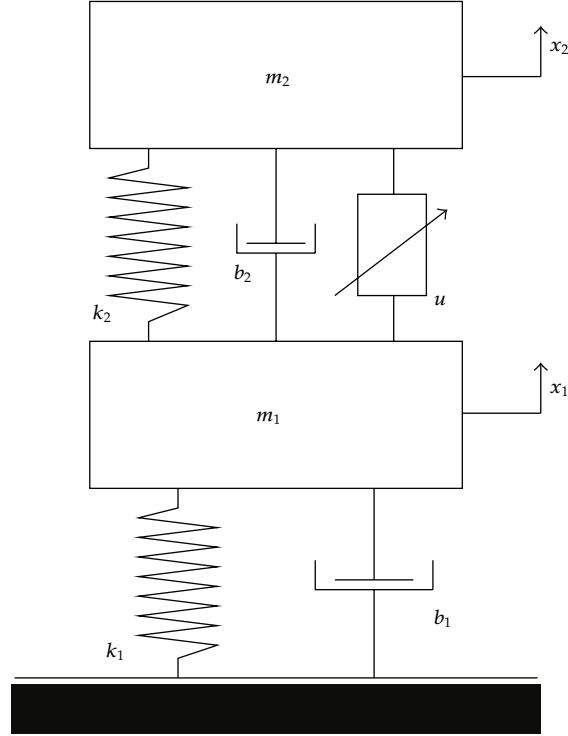

Figure 8: Mechanical vibration.

$\mathbf{K} = [9.6338 \times 10^3 \ 892.3611 \ 2774315 \ 265.7432]$. Figures 9 and 10 show the responses and the control inputs in which the initial conditions are $x(t_0) = [0.05 \ 0.05 \ 0.2 \ 0.2]^T$, and the states are disturbed by 1 unit at the time $t = 1.5$ s. Similar to the other examples, using the proposed method, the transient responses of the system states are reasonably good with moderate control input, and all the states converge to origin without steady-state errors. As shown in Figure 10, using the method [4, 19], some states cannot converge to origin properly although the control input is not high. As a result of applying the method [21], the same closed-loop pole locations can be placed through the use of two fictitious pole sets, namely, $\{-1, -2, -4, -5\}$ and $\{-5, -6, -10, -11\}$. This leads to two intermediate systems, respectively, denoted as

$$\sum_{\text{Int}}^1 = \mathbf{z}' = \begin{bmatrix} 0 & 1 & 0 & 0 \\ 0 & 0 & 1 & 0 \\ 0 & 0 & 0 & 1 \\ -40 & -60 & -49 & -12 \end{bmatrix} \mathbf{z} + \begin{bmatrix} 0 \\ 0 \\ 0 \\ 1 \end{bmatrix} u, \quad u = \hat{\mathbf{K}}_F \mathbf{z}', \quad (4.11)$$

$$\sum_{\text{Int}}^2 = \mathbf{z}' = \begin{bmatrix} 0 & 1 & 0 & 0 \\ 0 & 0 & 1 & 0 \\ 0 & 0 & 0 & 1 \\ -3300 & -630 & -371 & -2 \end{bmatrix} \mathbf{z} + \begin{bmatrix} 0 \\ 0 \\ 0 \\ 1 \end{bmatrix} u, \quad u = \bar{\mathbf{K}}_F \int_0^t \mathbf{z}(\tau) d\tau.$$

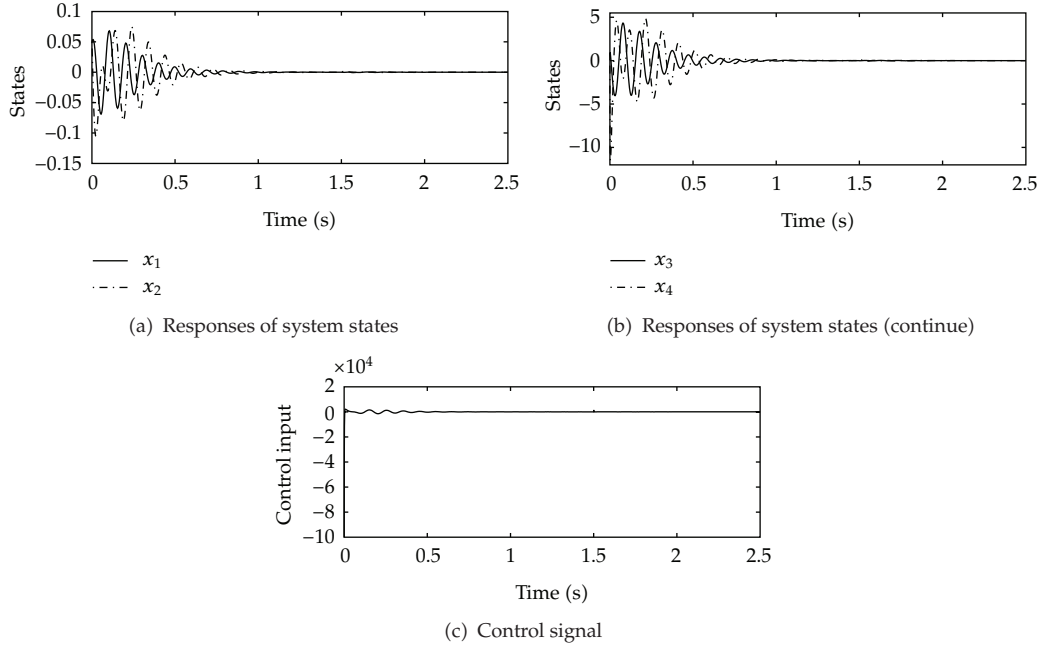

Figure 9: Responses of system states with the proposed method.

The obtained gain matrices are $\mathbf{K}_p = 10^3 \cdot [-391.1023 \ 35.9999 \ 1.0783 \ 0.0498]$, $\mathbf{K}_I = 10^3 \cdot [485.5644 \ 1032.9861 \ 355.9761 \ -28.0424]$, and $\mathbf{K}_d = [-1195.2561 \ 0.1455 \ -97.5520 \ 0.1236]$ with which a combined state-PID feedback controller is derived. Again, similar simulation results to those in Figure 9 are obtained. In order to show that arbitrarily chosen intermediate poles affect the gains, more results of applying the method [21] are included. All cases aim to achieve the same closed-loop pole locations at $\{-5 \pm 65j, -10 \pm 55j\}$. Two fictitious pole sets being considered are $\{-65, -60, -55, -50\}$ and $\{-45, -40, -35, -30\}$. This leads to two intermediate systems denoted as

$$\sum_{\text{Int}}^1 = \mathbf{z}' = \begin{bmatrix} 0 & 1 & 0 & 0 \\ 0 & 0 & 1 & 0 \\ 0 & 0 & 0 & 1 \\ -1.0725 \times 10^7 & -7.53250 \times 10^5 & -19775 & -230 \end{bmatrix} \mathbf{z} + \begin{bmatrix} 0 \\ 0 \\ 0 \\ 1 \end{bmatrix} u, \quad (4.12)$$

$$\sum_{\text{Int}}^2 = \mathbf{z}' = \begin{bmatrix} 0 & 1 & 0 & 0 \\ 0 & 0 & 1 & 0 \\ 0 & 0 & 0 & 1 \\ -1.89 \times 10^6 & -2.0625 \times 10^5 & -8375 & -150 \end{bmatrix} \mathbf{z} + \begin{bmatrix} 0 \\ 0 \\ 0 \\ 1 \end{bmatrix} u.$$

The following three feedback gains are obtained: $\mathbf{K}_p = 10^3 \cdot [1269 \ 6.2 \ 3 \ -2]$, $\mathbf{K}_I = 10^6 \cdot [-20.20188381 \ -0.03689236 \ -0.78515743 \ 0.00493426]$, and $\mathbf{K}_d = 10^3 \cdot [57.9939 \ -1.1587 \ -$

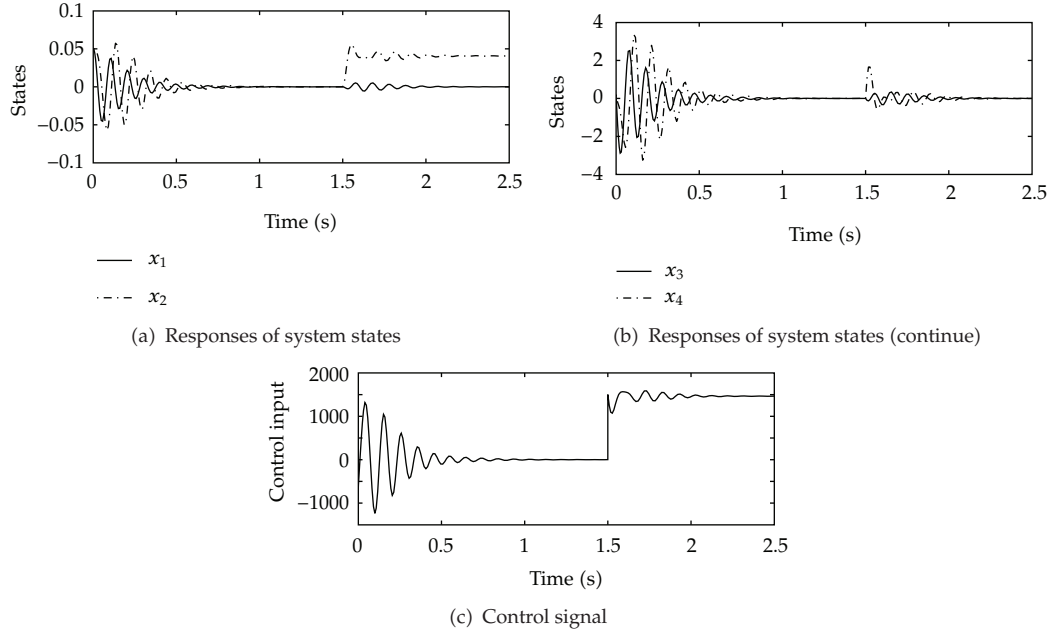

Figure 10: Responses of system states with the method [4, 19].

0.3011 - 0.0769]. Next, assume the following fictitious pole sets: $\{-10, -11, -12, -13\}$ and $\{-10 \pm 65j, -20 \pm 55j\}$ resulting in the following intermediate systems:

$$\sum_{\text{Int}}^1 = \mathbf{z}' = \begin{bmatrix} 0 & 1 & 0 & 0 \\ 0 & 0 & 1 & 0 \\ 0 & 0 & 0 & 1 \\ -17160 & -6026 & -791 & -46 \end{bmatrix} \mathbf{z} + \begin{bmatrix} 0 \\ 0 \\ 0 \\ 1 \end{bmatrix} u, \quad (4.13)$$

$$\sum_{\text{Int}}^2 = \mathbf{z}' = \begin{bmatrix} 0 & 1 & 0 & 0 \\ 0 & 0 & 1 & 0 \\ 0 & 0 & 0 & 1 \\ -1.4813125 \times 10^7 & -2.415 \times 10^5 & -8550 & -60 \end{bmatrix} \mathbf{z} + \begin{bmatrix} 0 \\ 0 \\ 0 \\ 1 \end{bmatrix} u.$$

The obtained gain matrices are $\mathbf{K}_p = 10^3 \cdot [-317.493774 \ 35.952333 \ 43.127038 \ 0.03327]$, $\mathbf{K}_I = 10^6 \cdot [-23.47560083 \ -0.03689236 \ -0.44368173 \ 0.04083183]$, and $\mathbf{K}_d = [-4418.3 \ 15.9617 \ -$

78.2139 2.1666]. As the final case, the fictitious pole sets are $\{-35 \pm 65j, -25 \pm 55j\}$ and $\{-10 \pm 65j, -20 \pm 55j\}$ resulting in two intermediate systems as follows:

$$\begin{aligned} \sum_{\text{Int}}^1 = \mathbf{z}' &= \begin{bmatrix} 0 & 1 & 0 & 0 \\ 0 & 0 & 1 & 0 \\ 0 & 0 & 0 & 1 \\ -1.98925 \times 10^7 & -5.28 \times 10^5 & -12600 & -120 \end{bmatrix} \mathbf{z} + \begin{bmatrix} 0 \\ 0 \\ 0 \\ 1 \end{bmatrix} u, \\ \sum_{\text{Int}}^2 = \mathbf{z}' &= \begin{bmatrix} 0 & 1 & 0 & 0 \\ 0 & 0 & 1 & 0 \\ 0 & 0 & 0 & 1 \\ -1.4813125 \times 10^7 & -2.415 \times 10^5 & -8550 & -60 \end{bmatrix} \mathbf{z} + \begin{bmatrix} 0 \\ 0 \\ 0 \\ 1 \end{bmatrix} u. \end{aligned} \quad (4.14)$$

The obtained gain matrices are $\mathbf{K}_p = 10^3 \cdot [301.2391 \ -19.2569 \ -2.6792 \ -1.4059]$, $\mathbf{K}_I = 10^6 \cdot [-23.47560083 \ -0.03689236 \ -0.44368173 \ 0.04083183]$, and $\mathbf{K}_d = [1930.8642 \ 565.8066 \ 342.0296 \ 30.7740]$.

The above case studies serve to show the effects of fictitious pole locations required by the method [21] on the designed gains, the magnitudes of which can be very large. Selection of fictitious poles is a critical problem of this previous method, which has been neither solved nor considered.

5. Conclusion

A new design method for pole placement via state-PID, -PI, and -PD feedback has been proposed. The method has two distinctive features: (i) compact design formulae and (ii) disturbance rejection property. The analyses of these features have been elaborated through relevant propositions. The paper also describes the design procedures and presents some illustrative examples including a magnetic ball suspension, an inverted pendulum, and mechanical vibration systems, respectively. The simulation results reflect that the proposed method is promising for a real-world application. A future work will be design optimization to achieve minimum gains subject to nonlinear restriction in control input and specified performance constraints.

Acknowledgments

The authors gratefully acknowledge the financial supports by Ratchamangkala University of Technology Isarn and Suranaree University of Technology, Thailand. The authors' appreciations are also due to the reviewers for their constructive comments.

References

- [1] W. G. Tuel, "On the transformation to (phase-variable) canonical form," *IEEE Transactions on Automatic Control*, vol. 11, p. 607, 1966.

- [2] W. M. Wonham, "On pole assignment in multi-input controllable linear systems," *IEEE Transactions on Automatic Control*, vol. 12, no. 6, pp. 660–665, 1967.
- [3] D. G. Luenberger, "Canonical forms for linear multivariable systems," *IEEE Transactions on Automatic Control*, vol. 12, no. 3, pp. 290–293, 1967.
- [4] J. Ackermann, "Der Entwurf linearer Regelungssysteme im Zustandsraum," *Regelung-Technik und Prozessdatenverarbeitung*, vol. 7, pp. 297–300, 1972.
- [5] V. A. Armentano, "Eigenvalue placement for generalized linear systems," *Systems & Control Letters*, vol. 4, no. 4, pp. 199–202, 1984.
- [6] J. Kautsky, N. K. Nichols, and P. Van Dooren, "Robust pole assignment in linear state feedback," *International Journal of Control*, vol. 41, no. 5, pp. 1129–1155, 1985.
- [7] C. Nguyen, "Arbitrary eigenvalue assignments for linear time-varying multivariable control systems," *International Journal of Control*, vol. 45, no. 3, pp. 1051–1057, 1987.
- [8] Y. Y. Wang, S. J. Shi, and Z. J. Zhang, "Pole placement and compensator design of generalized systems," *Systems & Control Letters*, vol. 8, no. 3, pp. 205–209, 1987.
- [9] F. Blanchini, "New canonical form for pole placement," *IEE Proceedings: Control Theory and Applications*, vol. 136, no. 6, pp. 314–316, 1989.
- [10] M. Valasek and N. Olgac, "Generalization of Ackermann's formula for linear MIMO time invariant and time varying systems," in *Proceedings of the 32nd Conference on Decisions and Control*, pp. 827–832, San Antonio, Tex, USA, December 1993.
- [11] M. Valasek and N. Olgac, "Efficient pole placement technique for linear time-variant SISO systems," *IEE Proceedings: Control Theory and Applications*, vol. 142, no. 5, pp. 451–458, 1995.
- [12] M. Valášek and N. Olgac, "Efficient eigenvalue assignments for general linear MIMO systems," *Automatica*, vol. 31, no. 11, pp. 1605–1617, 1995.
- [13] T. H. S. Abdelaziz and M. Valasek, "A direct algorithm for pole placement by state-derivative feedback for single-input linear systems," *Acta Polytechnica*, vol. 43, no. 6, pp. 52–60, 2003.
- [14] T. H. S. Abdelaziz and M. Valášek, "Pole-placement for SISO linear systems by state-derivative feedback," *IEE Proceedings: Control Theory and Applications*, vol. 151, no. 4, pp. 377–385, 2004.
- [15] S.-K. Kwak, G. Washington, and R. K. Yedavalli, "Acceleration feedback-based active and passive vibration control of landing gear components," *Journal of Aerospace Engineering*, vol. 15, no. 1, pp. 1–9, 2002.
- [16] E. Reithmeier and G. Leitmann, "Robust vibration control of dynamical systems based on the derivative of the state," *Archive of Applied Mechanics*, vol. 72, no. 11–12, pp. 856–864, 2003.
- [17] T. H. S. Abdelaziz and M. Valasek, "State derivative feedback by lqr for linear time-invariant systems," in *Proceeding of 16th IFAC World Congress*, vol. 16, Prague, Czech Republic, July 2005.
- [18] M. R. Moreira, E. I. Mainardi Júnior, T. T. Esteves et al., "Stabilizability and disturbance rejection with state-derivative feedback," *Mathematical Problems in Engineering*, vol. 2010, Article ID 123751, 12 pages, 2010.
- [19] K. Ogata, *Modern Control Engineering*, Prentice Hall, New York, NY, USA, 2002.
- [20] B. C. Kuo, *Automatic Control Systems*, Prentice-Hall, New York, NY, USA, 1987.
- [21] G. Guo, Z. Ma, and J. Qiao, "State-PID feedback control with application to a robot vibration absorber," *International Journal of Modelling, Identification and Control*, vol. 1, no. 1, pp. 38–43, 2006.



Hindawi

Submit your manuscripts at
<http://www.hindawi.com>

