

A class of locally conformally flat 4-manifolds

Selman Akbulut and Mustafa Kalafat

ABSTRACT. We construct infinite families of nonsimply connected locally conformally flat (LCF) 4-manifolds realizing rich topological types. These manifolds have strictly negative scalar curvature and the underlying topological 4-manifolds do not admit any Einstein metrics. Such 4-manifolds are of particular interest as examples of Bach-flat but non-Einstein spaces in the nonsimply connected case. Besides that the underlying smooth manifolds are examples of spaces that admit open book decomposition in dimension 4.

CONTENTS

| | |
|---------------------------------|-----|
| 1. Introduction | 733 |
| 2. Panelled web groups | 737 |
| 3. Handlebody diagrams | 745 |
| 4. Invariants | 752 |
| 5. Sequences of metrics | 754 |
| 6. Sign of the scalar curvature | 757 |
| References | 761 |

1. Introduction

A Riemannian n -manifold (M, g) is called *locally conformally flat (LCF)* if there is a function $f : U \rightarrow \mathbb{R}^+$ in a neighborhood of each point $p \in M$ such that $\tilde{g} = fg$ is a flat metric on U . It turns out that there is a simple tensorial description of this elaborate condition. The Weyl curvature tensor is defined as

$$W_{ijkl} = R_{ijkl} + \frac{R}{(n-1)(n-2)} \begin{vmatrix} g_{ik} & g_{il} \\ g_{jk} & g_{jl} \end{vmatrix} - \frac{1}{n-2} \left(\begin{vmatrix} R_{ik} & g_{il} \\ R_{jk} & g_{jl} \end{vmatrix} + \begin{vmatrix} g_{ik} & R_{il} \\ g_{jk} & R_{jl} \end{vmatrix} \right).$$

It is a nice exercise in tensor analysis [JV] that for $n \geq 4$, M is LCF if and only if $W = 0$. In dimension 3 this role is taken over by the *Cotton* tensor,

Received June 28, 2012.

2010 *Mathematics Subject Classification.* 53C25, 57R65.

Key words and phrases. Locally conformally flat metrics, Kleinian groups, scalar curvature, handlebody theory.

The first named author is partially supported by NSF grant DMS 9971440.

and in dimension 2 all manifolds are LCF. The Weyl curvature tensor yields a symmetric operator $\mathcal{W} : \Lambda^2 \rightarrow \Lambda^2$ defined by the formula

$$\mathcal{W}(\omega) = \frac{1}{4} W_{ijkl} \omega_{kl} e^i \wedge e^j$$

where $\{e^1, \dots, e^n\}$ is an orthonormal basis of the 1-forms. We are mainly concerned with dimension 4, and in this case the space of the 2-forms decomposes into the ± 1 eigenspaces of the Hodge star operator $\Lambda^2 = \Lambda^2_+ \oplus \Lambda^2_-$. Furthermore the operator \mathcal{W} sends (anti-) self-dual 2-forms to (anti-) self-dual 2-forms, hence inducing the decomposition $\mathcal{W} = \mathcal{W}^+ \oplus \mathcal{W}^-$. We call a Riemannian manifold M *self-dual (SD)* if $\mathcal{W}^- = 0$, and *anti-self-dual (ASD)* if $\mathcal{W}^+ = 0$. In these terms M is LCF if and only if it is SD and ASD at the same time. For basics of LCF manifolds we refer to [Mat, JV]. Some common examples in dimension four are the manifolds with constant sectional curvature, product of two constant sectional curvature metrics of curvature 1 and -1 , e.g., $S^2 \times \Sigma_g$ for $g \geq 2$, product of a manifold of constant sectional curvature with S^1 or \mathbb{R} . See [K] for a recent survey of LCF and self-dual structures on basic 4-manifolds. Our main result is the following.

Theorem 1.1. *There are infinite families of closed, nonsimply connected, locally conformally flat 4-manifolds, called panelled web 4-manifolds, with Betti number growth: $b_1 \rightarrow \infty$, $b_2 \rightarrow \infty$ or bounded, and $\chi \rightarrow -\infty$. These manifolds have strictly negative scalar curvature.*

We show that many new topological types can be realized. The idea is to conformally compactify $S^1 \times M^3$ where M is a hyperbolic 3-manifold with boundary. The reader will see that the resulting manifold is closed but it is not simply S^1 cross a 3-manifold. It is obtained through spinning around the boundary of the 3-manifold. Recall:

Theorem 1.2 ([Br]). *Let \bar{M}^3 be an oriented, geometrically finite complete hyperbolic manifold with nonempty boundary, such that $\partial\bar{M} = \cup S_j$ consists of either a disjoint union surfaces of genus ≥ 2 , or $\bar{M} = D^2 \times S^1$. Let M be the interior of \bar{M} . Then $M \times S^1$ has a oriented closed, smooth conformal compactification X^4 , with an S^1 action.*

X is locally conformally flat (LCF). The action has the fixed point sets conformal to the boundary surfaces $\cup S_j$ of \bar{M} (the ideal points of the compactification). The normal bundles of the fixed surfaces are trivial with S^1 weight 1. The hyperbolic structure on M can be recovered from X by giving $X - \cup S_j$ the metric in the conformal class for which the S^1 orbits have length 2π . Then M is the Riemannian quotient of $X - \cup S_j$ by S^1 .

In particular the connected sums $\sharp_n S^3 \times S^1$ and $S^2 \times \Sigma_g$ for $g \geq 2$ can be obtained from this theorem. In the first case we begin with several cyclic groups of isometries of \mathbb{H}^3 each of which yields a quotient $D^2 \times S^1$, combining them by the first combination theorem gives a classical Schottky group corresponding to the boundary connected sums of the corresponding

$D^2 \times S^1$ s. Boundary connected sum in three dimensions corresponds to the (S^1 equivariant conformal) connected sum in four dimensions. In the second case we begin with a Fuchsian group of isometries of \mathbb{H}^3 , yields a quotient $I \times \Sigma_g$.

In this paper we begin with a more general class of Kleinian groups called the *panelled web groups*, constructed by Bernard Maskit in [MaPG]. After the application of the Theorem 1.2, we obtain 4-manifolds with more complicated topology. We describe concrete handlebody pictures of these manifolds in terms of framed links, which describes their smooth topology. We will call these LCF manifolds *panelled web 4-manifolds*. We hope that our concrete “visual” techniques here will be useful in constructing special metrics on other manifolds, especially the other nonsimply connected ones.

We are also able to compute the sign of the scalar curvature for the panelled web 4-manifolds. Recall that by the solution of the Yamabe problem, any Riemannian metric on a closed manifold is conformally equivalent to the one with constant scalar curvature. And the sign of this constant is an invariant of the conformal structure, called the *type* of the metric or its conformal class. Using the results of [LeSD] and additionally [SY, Na] we can show the following.

Theorem 1.3. *The conformal class of the natural metric on the panelled web 4-manifolds is of negative type, i.e., the metric can be rescaled to have constant negative scalar curvature. In the case of $b_2 \neq 0$, more generally the underlying topological manifolds of panelled web 4-manifolds do not admit any locally conformally flat metric of positive or zero scalar curvature.*

Considering the natural metric of these manifolds, one can also directly compute its sign through the Hausdorff dimension of the Kleinian groups used to uniformize the related hyperbolic 3-manifold. See Section 6 for the details.

Finally, we can give an answer to the problem of whether the underlying smooth 4-manifolds admit any Einstein metric. We compute the Euler characteristics of the manifolds we construct. The Euler characteristics of the building blocks are all strictly negative, since the Euler characteristic is additive, and it turns out to be strictly negative for all of our panelled web 4-manifolds. By the generalized Gauss–Bonnet Theorem we express the Euler characteristic χ of a 4-manifold as

$$\chi(M) = \frac{1}{8\pi^2} \int_M \frac{s^2}{24} - \frac{|\overset{\circ}{\text{Ric}}|^2}{2} + |W|^2 \, dV_g.$$

If M admits an Einstein metric, then the trace free Ricci curvature tensor

$$\overset{\circ}{\text{Ric}} = \text{Ric} - \frac{s}{4}g$$

vanishes identically. So that $\chi \geq 0$, which implies the following:

Theorem 1.4. *The topological manifolds underlying the panelled web 4-manifolds do not admit any Einstein metrics.*

This is interesting because of the following. Einstein metrics are have vanishing Bach tensor, so that they are Bach-flat (BF). LCF metrics are also BF. Then our examples are BF but not Einstein. Therefore, in the highly nonsimply connected case, these examples illustrates the converse statement. See also 6.32 of [Bes] for simpler examples. It is easier to give simply-connected examples of this phenomenon; $\sharp_n \mathbb{C}P_2$ carries self-dual metrics by [LeEx] however no Einstein metric for $n \geq 4$ by the Hitchin–Thorpe inequality.

It is a curious question whether these smooth manifolds carry any optimal metric [LeOM]. Since they do not admit any Einstein metric, the first possibility is eliminated. Another possibility of being scalar-flat anti-self-dual (SF-ASD) can also be eliminated in $b_2 \neq 0$ case, since the techniques mentioned in Section §6 goes through in this case as well. Besides that, since the signature of these manifolds vanish, self-duality or anti-self-duality of the metric is equivalent to being locally conformally flat in this case. Consequently the optimal metric problem currently remains open for these manifolds.

Note that the handlebody pictures are essential to deal with nonsimply connected manifolds in general. This is the standard and only way to define and understand them generally. Otherwise one trapped into products and connected sums. There is no way to get complicated topological types other than showing the explicit surgery scheme. They are somehow the definition of the manifolds. Products of simple manifolds and their connected sums constitute a set of measure zero in the whole family of nonsimply connected 4-manifolds. Because of this reason, we consider this study as a foundational work to analyze, give examples of LCF (and also SD) metrics on nonsimply connected spaces. This work has many further applications. In a forthcoming paper [AKO] using the techniques here, we construct self-dual but not locally conformally flat metrics on families of nonsimply connected 4-manifolds with small signature. Secondly, in [AK] we analyze the existence of symplectic, almost complex and complex structures on the panelled web 4-manifolds constructed here, and give interesting counterexamples. More applications are on the way.

In Section 2 we review the hyperbolic 3-manifolds which we use in our constructions. In Section 3 we describe the topology of the building blocks of the 4-manifolds in interest, by constructing their handlebody pictures. In Section 6 we compute the sign of the scalar curvature of the metrics on these manifolds. In Section 4 we compute the algebraic topological invariants of these 4-manifolds. Finally in Section 5 we construct interesting sequences of locally conformally flat 4-manifolds by using these building blocks.

Acknowledgments. The second author would like to thank to Claude LeBrun for his suggestions, Bernard Maskit, for generously sharing his knowledge, and many thanks to Alphan Es, Jeff Viaclovsky, Yat-Sun Poon, Caner Koca, Feza Gürsey Institute members at İstanbul. The figures are sketched by the program IPE of Otfried Cheong. We thank Selahi Durusoy for helping with the graphics. Also thanks to the anonymous referee for many useful comments.

2. Panelled web groups

In this section we will describe the 3-manifolds from which we construct our LCF 4-manifolds. These are closed hyperbolic 3-manifolds, which are obtained by dividing out the hyperbolic 3-space \mathbb{H}^3 with a group of its isometries. The isometry group is a discrete group obtained out of certain Fuchsian and extended-Fuchsian groups, by taking their combinations using the theorems of Maskit. In 1981 B. Maskit introduced this new class of Kleinian groups called the *panelled web groups*, and gave a set of examples. Here we first review the constructions in [MaPG].

Definition 2.1. A *Fuchsian group* is a discrete group of fractional linear transformations $z \mapsto (az + b)/(cz + d)$ acting on the hyperbolic plane¹ \mathbb{H}^2 , where $ad - bc \neq 0$ and a, b, c, d are real. The group is of the *first kind* if every real point is a limit point, it is of the *second kind* otherwise.

Möbius transformations can be written as a composition of reflections and inversions. These motions act on the extended complex line $\hat{\mathbb{C}}$ as well as on the upper half space $\mathbb{H}^3 = \{(z, t) | z \in \mathbb{C}, t \in \mathbb{R}^+\}$ by the usual way. In our case the transformations preserve the \mathbb{H}^2 so that they are written as a product of reflections and inversions in lines and circles which are orthogonal to the real line. The extended motions in \mathbb{H}^3 preserve the planes passing through the real line, it follows that if G is a Fuchsian group then, $\mathbb{H}^3/G = \mathbb{H}^2/G \times (0, 1)$.

A group of Möbius transformations is called *elementary* if it has at most two limit points. As an example, a hyperbolic cyclic group

$$H = \langle z \mapsto \lambda^2 z \rangle, \quad \lambda \neq 1$$

or its conjugates has two limit points and \mathbb{H}^2/H is an annulus. Another is a trivial group, it has no limit point and $\mathbb{H}^2/\{1\}$ is a disk. Let $\Sigma_{g,n}$ be the interior of a compact orientable surface with boundary, where g and n stand for the genus and number of boundary components, respectively. Assume $\Sigma_{g,n}$ is neither a disk nor an annulus. Then there is a purely hyperbolic, nonelementary Fuchsian group of the second kind G so that $\mathbb{H}^3/G = \Sigma_{g,n} \times (0, 1)$. Conversely, if G is a finitely generated, purely hyperbolic, nonelementary Fuchsian group of the second kind, then \mathbb{H}^2/G is the interior of a compact

¹We will be using the upper half plane model of the hyperbolic plane throughout this paper.

orientable surface with boundary neither a disk nor an annulus, so that $\mathbb{H}^3/G = \Sigma_{g,n} \times (0, 1)$.

We can construct the group G corresponding to the surface of genus g with n boundary components using $4g + 2(n - 1)$ disjoint, identical circles $C_1, C'_1 \cdots C_{2g+n-1}, C'_{2g+n-1}$ centered at the real line. The generators of G will be Möbius transformations a_i mapping C_i to C'_i , which can be constructed as a composition of an inversion in C_i followed by a reflection in the perpendicular bisector of the centers of the two circles. Using either of the combination theorems, we see that the group G generated by $a_1 \cdots a_{2g+n-1}$ is discrete, and acts freely on \mathbb{H}^2 . Figure 1 shows the case for $g = 1$ and

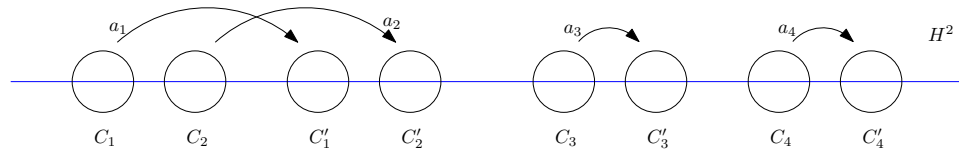

FIGURE 1. Schottky generators for the Fuchsian group for $\Sigma_{1,3}$.

$n = 3$. Notice that each generator a_3, a_4 generates a hole, on the other hand the generators producing the genus a_1, a_2 altogether generates only one hole as they stick all the nearby boundary components together. The quotient \mathbb{H}^3/G is the product $\Sigma \times (0, 1)$ is the interior of $\Sigma \times I$ for $I = [0, 1]$ which is called an *I-bundle of type (i)* or a *trivial I-bundle* on Σ . If there is an orientation *reversing*, free, involutive homeomorphism $h : \Sigma \rightarrow \Sigma$, we extend h to an orientation *preserving* homeomorphism

$$h' : \Sigma \times I \rightarrow \Sigma \times I \quad \text{by} \quad h'(x, t) = (h(x), 1 - t),$$

then we call the quotient $\Sigma \times I/h'$ to be an *I-bundle of type (ii)* or a *twisted I-bundle associated to Σ* or *over Σ/h* . Next we will construct the Kleinian groups corresponding to the twisted I-bundles.

Definition 2.2. A nonelementary Kleinian group which is not itself Fuchsian, but contains a subgroup of index 2 which is Fuchsian, is called an *extended Fuchsian group*.

A Möbius transformation is called *parabolic*, *loxodromic* or *elliptic* if the number of its fixed points in \mathbb{H}^3 is one, two or infinity, respectively. *Hyperbolic* elements are the transformations conjugate to $z \mapsto \lambda z, \lambda > 1$, which are also loxodromic. Besides, a transformation is *elliptic* iff it has a fixed point in \mathbb{H}^3 .

If we start with a finitely generated, nonelementary, purely loxodromic extended Fuchsian group G , we can write $G = \langle g, G^0 \rangle$, for some Fuchsian group G^0 , so that $gG^0g^{-1} = G^0$ and $g^2 \in G^0$ ([MaPG, MaKG, MaTa]). After renormalizing we can assume that g has fixed points at $0, \infty$ and then g maps a Euclidean plane passing through the real line with an inclination

of α with the upper half plane onto a Euclidean plane also passing through the real line with inclination of $\pi - \alpha$ degrees. The plane with $\alpha = \pi/2$ is kept invariant. G has no elliptic elements so it is torsion-free, implying that the action of g on the $\alpha = \pi/2$ plane can have fixed points only on the real axis. We conclude that \mathbb{H}^3/G is equal to the \mathbb{H}^3/G^0 modulo the action of g , so is an I-bundle of type (ii) over \mathbb{H}^2/G .

To construct our 3-manifolds, we glue the hyperbolic 3-manifolds obtained out of the quotients of Fuchsian and extended-Fuchsian groups. The gluing is done along the cylinders. If we begin with the case $n > 0$, i.e., surfaces with holes, then the quotient 3-manifolds have cylinders along the boundary, corresponding to the boundary curves. These are of the form $W \times I$ for a boundary curve W . Each boundary cylinder has a *median* $W \times \{1/2\}$ on it, which divides it into two *half cylinders*. The gluing procedure is to glue these half cylinders by the standard homeomorphism matching the medians to get a connected 3-manifold at the end, which does not have any more spare (unglued) half cylinders. Then we finish the construction with the optional complex twist operation along some of the medians. All of these operations are done using the combination theorems, which never lead us out of the class of geometrically finite groups. Gluing the half cylinders of two different 3-manifolds is achieved by the following:

Theorem 2.3 (First Combination [MaC1, MaC3]). *Let G_1 and G_2 be Kleinian groups with a common subgroup H . Let C be a simple closed curve dividing $\hat{\mathbb{C}}$ into the topological disks B_1, B_2 where B_i is precisely invariant under H in G_i . Then the group G generated by G_1 and G_2 is discrete, and G is the free product of G_1 and G_2 with amalgamated subgroup H . If D_i 's are fundamental domains for G_i 's, where $D_i \cap B_i$ is a fundamental domain for the action of H on B_i , then $D_1 \cap D_2$ is a fundamental domain for G .*

Here, a subset A of $\hat{\mathbb{C}}$ is said to be *precisely invariant* under the subgroup H in G , if $h(A) = A$ for every $h \in H$ and $g(A) \cap A = \emptyset$ for every $g \in G \setminus H$. Let us illustrate this gluing with an example from [MaPG] with a Fuchsian group G_1 and an extended-Fuchsian group G_2 , which will correspond to the trivial and twisted I-bundles over $\Sigma_{1,2}$. Here G_1 is generated by the elements whose actions are described by the circles $C_1, C'_1 \cdots C_4, C'_4$. We choose the circles generating the genus closer to each other so that they do not generate an extra hole, this reduces the number of boundary circles to two. We label the elements generating these holes as b and a , and slide the center of the circle C'_4 to the right on the real axis till it reaches $+\infty$ and then slide back from $-\infty$ to the right till it reaches to the origin. So that the outside of C_4 is mapped inside of C'_4 contrary to the standard mapping in Figure 1. The fundamental region of G_1 as a Kleinian group looks like Figure 2. C'_4 is the large and C_4 is the small circle centered at the origin. By our choice of the circle C'_4 we intend to provide the common subgroup to be $H = \langle a \rangle$ where $a : z \mapsto \lambda z, \lambda > 1$. a is a dilation which is still a schottky generator. The dotted lines and circles denote the *lens angle* for

a and b , which is the smallest angle between the real axis and the largest precisely invariant circular region bounded above by a circle passing through the fixed points of the group, and below by the real axis. It is denoted by φ_H . Incidentally, a and b are the *boundary elements* of this Fuchsian group, e.g., the generators of the hyperbolic cyclic subgroups of a Fuchsian group of the second kind keeping invariant the segment of the real axis on which the group acts discontinuously. The dashed circles enclose invariant regions for the boundary elements a and b . The two lines stand for the parts of circles at infinity.

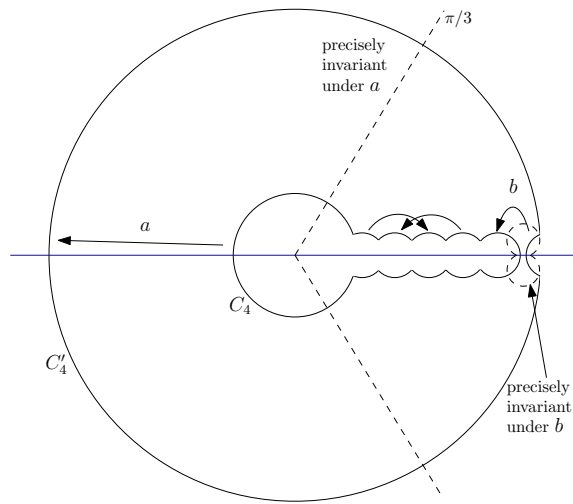

FIGURE 2. *Fundamental region of G_1 as a Kleinian group.*

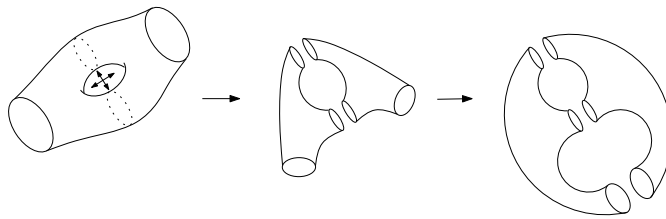

FIGURE 3. *$\Sigma_{1,2}$ with its involution and how it sits in the fundamental region for G_2 .*

The fundamental region for G_2 is constructed in a more complicated way. We begin with the Fuchsian group generating $\Sigma_{0,3}$, such that one of the holes is generated by the same a as in G_1 . We then add a new generator g_2 mapping the rest of the holes to one another. Adjoining this new element g_2 can be considered as an application of the second combination Theorem 2.4. G_2 corresponds to the twisted I-bundle over $\Sigma_{1,2}$.

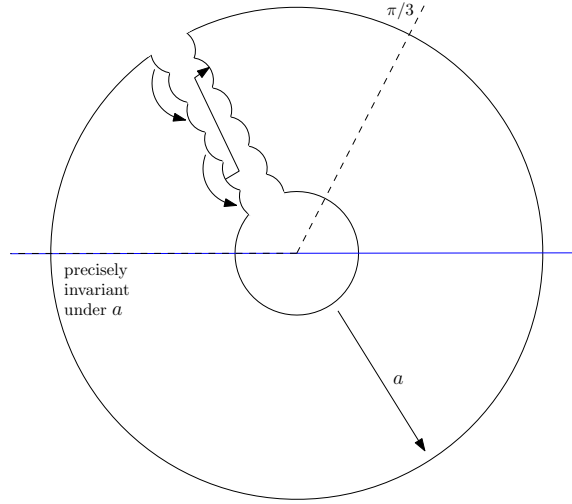

FIGURE 4. *Fundamental region of G_2 as a Kleinian group.*

Finally, we conjugate the group by $g : z \mapsto \exp(2\pi i/3)z$ to rotate the fundamental region by $\pi/3$ in the counter clockwise direction so that the fixed points, geodesics of the elements of G_2 generated by other than a lies on the other side of the line $C : \theta = \pi/3$, as in Figure 4 . We direct the reader to [MaPG] for details. To apply the combination theorem, we take the line C as the separating circle which separates $\hat{\mathbb{C}}$ into the disks B_1, B_2 lying on the left and right hand side in the Figure 5, respectively. We choose our lens angles $\varphi < \pi/3$ so that B_i is precisely invariant under $H = \langle a \rangle$ in G_i . The combination theorem says that the group generated by G_1 and G_2 is discrete. A fundamental domain is as in Figure 5.

In three dimension, we glued the cylinder of the twisted I-bundle to a cylinder of the trivial I-bundle along L/H where L is the geodesic plane in \mathbb{H}^3 with boundary C . However we only want to glue the half-cylinders. We can take apart the glued half-cylinders and glue back in a different way using the second combination theorem.

Theorem 2.4 (Second Combination [MaC2, MaC3]). *Let G be a Kleinian group with subgroups H_1 and H_2 . Let B_1, B_2 be two disjoint topological disks where (B_1, B_2) is precisely invariant under (H_1, H_2) pairwise. Suppose there is a Möbius transformation f mapping the interior of B_1 onto the exterior of B_2 , where $fH_1f^{-1} = H_2$. Then the group G^* generated by G and f is discrete, has the relations of G and $fH_1f^{-1} = H_2$. A fundamental domain is given by $D \cap \text{ext}(B_1) \cap \text{ext}(B_2)$, where D is a fundamental domain for G .*

Here, the *pairwise precise invariance* of $\{A_1, A_2\}$ means the usual invariance with the condition that $gA_i \cap A_j = \emptyset$ for $i \neq j$ and for any $g \in G$. We apply this theorem to the subgroups $\langle a \rangle$ and $\langle b \rangle$ in the group G , which we

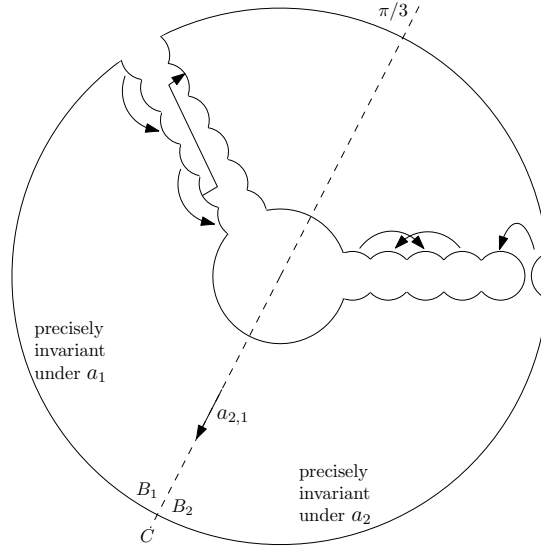

FIGURE 5. *Fundamental region of the first combination of G_1 and G_2 along $\langle a \rangle$.*

have constructed above. We arrange the loxodromic transformations a and b such that they are conjugate to the transformation $z \mapsto \lambda z$ with the same λ called the *multiplier*, so that they are conjugate to each other. Choose B_1 as the sector $|\arg z - 4\pi/3| < \varphi$ where $\varphi < \pi/3$. It is clearly precisely invariant under $H_1 = \langle a \rangle$ in G . We choose B_2 to be the inside of the circular arcs passing through the fixed point of the group $H_2 = \langle b \rangle$. We take out the sector and inside the circular arcs, and glue the boundaries by the theorem. See Figure 6.

In three dimensions, recall that applying the first combination, we have glued a cylinder of the trivial I-bundle to the cylinder of the twisted I-bundle. Application of the second combination tears apart one of these glued half-cylinders, and glues the half-cylinder of the trivial I-bundle to its opposite half-cylinder, glues the spare half-cylinder of the trivial I-bundle to the spare half-cylinder of the twisted I-bundle. Figure 7 shows the identifications before and after the application of the second combination theorem.

Our final operation is the p/q complex twist operation for relatively prime integers p and q . We illustrate the case for $p/q = 1/3$. This will be nothing but the application of the Second Combination Theorem to G and $H_0 = \langle a_0 \rangle$, where $a_0 : z \mapsto \lambda^{1/3} \exp(2\pi i/3)z$ and the common subgroup is taken to be $H_1 = \langle a \rangle$, where $a : z \mapsto \lambda z, \lambda > 1$. If we consider the isomorphism $H_0 \approx \mathbb{Z}$, then H_1 will correspond to the $3\mathbb{Z}$ in \mathbb{Z} since $a_0^3 = a$. A fundamental region in $\hat{\mathbb{C}}$ for H_1 is an annulus of radii 1 and λ . The quotient \mathbb{H}^3/H_1 is an open hyperbolic solid torus. As we adjoin the elements generated by a_0 to the group, two thirds of the annulus becomes redundant, a sector of

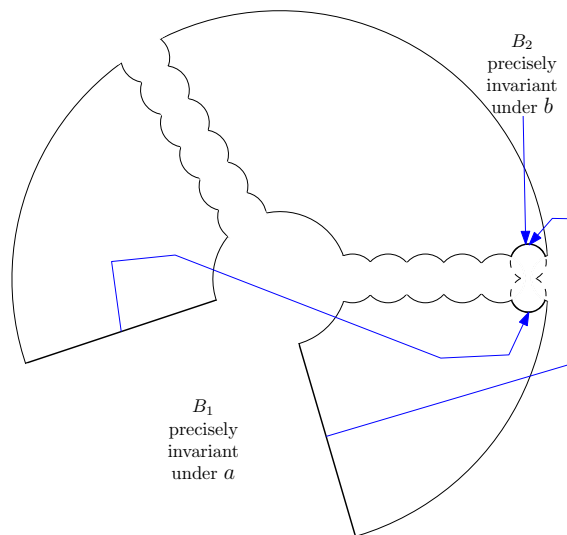

FIGURE 6. Application of the second combination theorem.

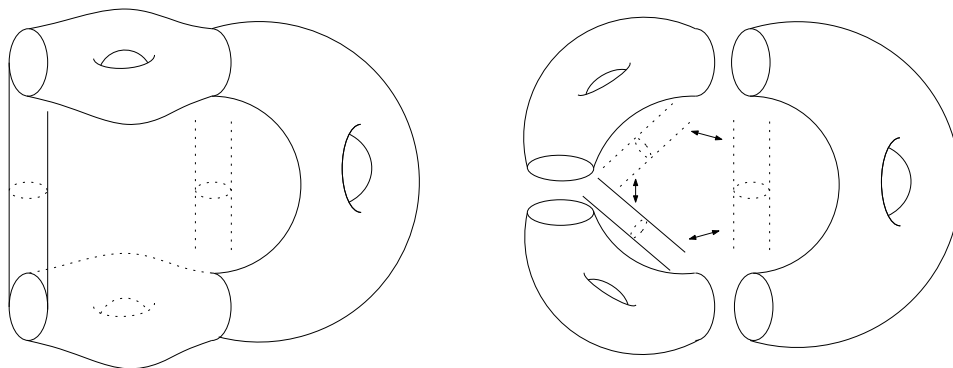

FIGURE 7. Effects of the first and second combination theorems in 3 dimensions.

$2\pi/3$ degrees becomes the fundamental region for H_0 as in Figure 8. The hyperbolic quotient again becomes a solid torus, obtained from a Dehn twist.

We have to normalize G so that its fundamental region fits into the annulus piece. For this purpose, G_2 is joined into G via conjugation $z \mapsto \exp(2\pi i/9)z$ by rotating $2\pi/9$ degrees rather than $2\pi/3$, so that the identified circles stays inside the annular region between $-\pi/9$ and $5\pi/9$. Besides, apply the first combination theorem to G_1 and G_2 taking the region B_1 as $|\arg z - 4\pi/9| < \varphi$ with $\varphi < \pi/9$, and B_2 as before with its new lens angle φ . Now to combine the annular region with G , we take B'_1 as the annular region $|\arg z - \pi/9| < \varphi$ which is precisely invariant under $H_1 = \langle a \rangle$

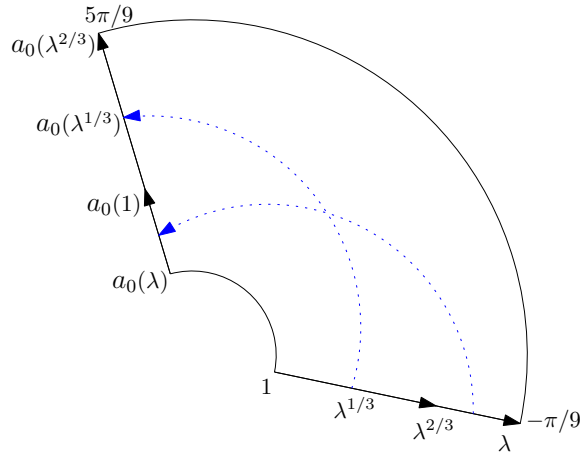

FIGURE 8. A fundamental region for H_0 .

in H_0 . Take B'_2 to be the complementary region $|5\pi/9 < \arg z < 2\pi - \pi/9|$ precisely invariant under H_1 in renormalized G . Figure 9 shows the resulting fundamental region. Recall that \mathbb{H}^3/H_0 is a hyperbolic solid torus topolog-

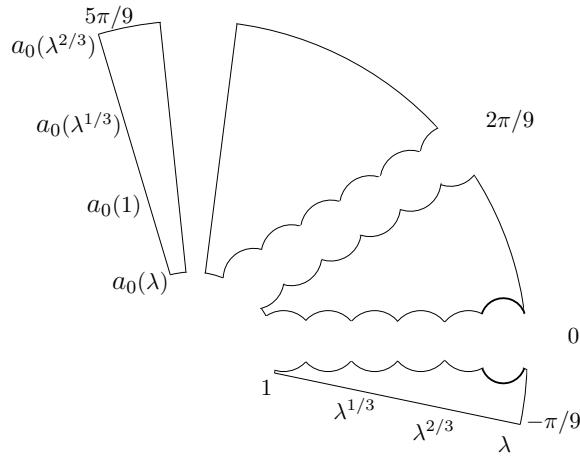

FIGURE 9. Fundamental region after $1/3$ -complex twist.

ically obtained after applying three Dehn twists to the solid torus \mathbb{H}^3/H_1 . The ray $\{(z, t) | z = 0, t > 0\} \subset \mathbb{H}^3$ projects onto the central loop of the solid tori, where it is homotopic to the $(1, 0)$ curve, the parallel on \mathbb{H}^3/H_1 . On the other hand it is homotopic to the $(1, 3)$ torus knot on the boundary of \mathbb{H}^3/H_0 . The second solid torus is opened up along this homotopy, and glued back onto an opened up median of \mathbb{H}^3/G in three dimensions.

3. Handlebody diagrams

In this section we will draw handlebody diagrams of the some of the LCF 4-manifolds constructed from the 3 manifolds of the previous section via the application of the Theorem 1.2. We will begin with $\Sigma_{1,2}$, the torus with two holes, then cross it with the interval $I = [0, 1]$, and then glue the boundary cylinders with each other either trivially or with a flip. Then by gluing a solid torus to this (along the p/q knot in its boundary) to obtain the panelled web 3-manifold. We then cross this with S^1 and identify its boundary to obtain the panelled web 4-manifold.

Figure 10 is a handlebody picture of the twice punctured 2-torus: It consists of a 2-disk (i.e., 0-handle) with three 1-handles attached to its boundary, and one 2-handle (attached along the outer boundary of the figure). Then Figure 11 is just the thickening of this handlebody, which is the *Heegard diagram* of $I \times \Sigma_{1,2}$.

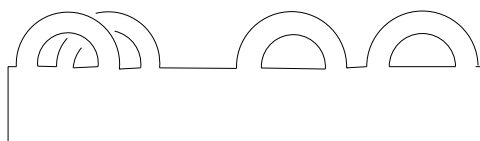

FIGURE 10. *One-handles of the torus with two punctures.*

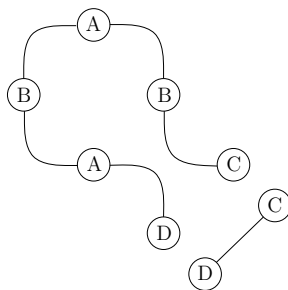

FIGURE 11. *Heegard Diagram for $I \times \Sigma_{1,2}$.*

Now, we identify the two boundary cylinders in $I \times \Sigma_{1,2}$ via the Second Combination Theorem of Maskit [MaKG, MaPG]. We can do this in two different ways, either trivially or with a twist. We will sketch the pictures of the manifolds resulting from both ways of gluing. This identification glues the neighborhoods of the middle circles (called the *medians* [MaPG]) of the cylinders. As shown in Figure 12.

This operation of identifying the neighborhoods of the two circles, is usually called the attaching a *round 1-handle* operation. A round 1-handle is a combination of a 1-handle and a 2-handle as illustrated in Figure 13.

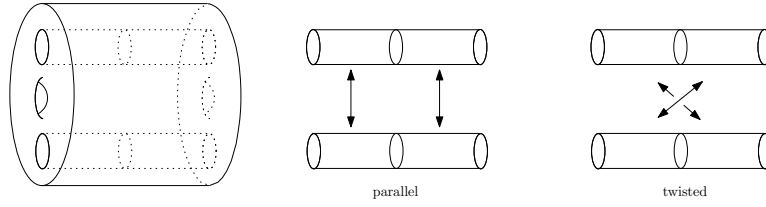

FIGURE 12. Identification of the boundary cylinders.

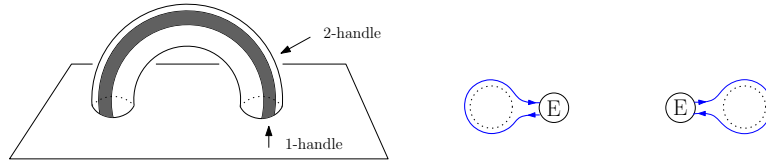

FIGURE 13. 2- and 3-dimensional round handles.

In the diagram of Figure 14, the $median_1$ and the $median_2$ are the cores of the 1-handles C and D, respectively. This is because the median circles lie on the cylinders, which make the holes on the 3-manifold, and we formed these holes by the 1-handles C and D.

There are two different ways of gluing the neighborhoods of the meridians. Both ways are illustrated in Figure 14. In our figure we flipped the hole i.e., the 1-handle so that we can obtain one identification from the other. We will call one *cross identification* (the left picture), and the other *parallel identification* (the right picture). In general the two different ways of attaching the round 1-handles give nondiffeomorphic 3-manifolds. (e.g., Figure 15)

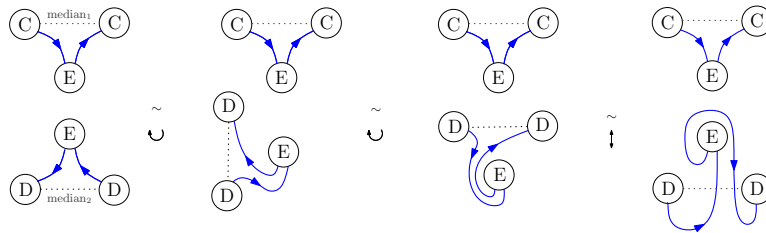

FIGURE 14. Obtaining the parallel round handle from the cross round handle.

The final operation to perform is to add a p/q twist to this handlebody by gluing a solid torus to it. This is done by identifying an annulus on its boundary with a neighborhood of a p/q torus knot on the boundary of the solid torus, where p is the multiplicity of the meridian direction. Since the p/q curve is isotopic to $1/q$ curve in the solid torus, it suffices to take $p = 1$.

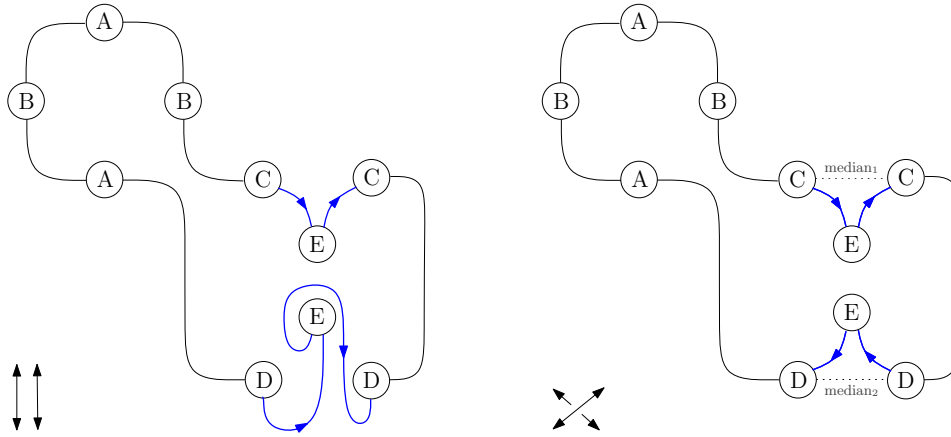

FIGURE 15. Two different ways of inserting the round handle.

The solid torus here is viewed as a 1-handle, with a p/q torus knot lying on its boundary. In Figure 16 we sketch the $1/3$ torus knot as an example. This operation is similar to attaching a round handle operation (since we

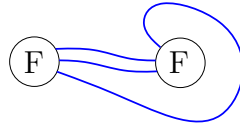

FIGURE 16. $1/3$ torus knot on the 1-handle.

are identifying two circles), it is achieved with a 1-handle and a 2-handle addition as in Figure 17. This finalizes the picture of the Maskit’s panelled web 3-manifold.

To pass to the 4-manifold, we cross this 3-manifold with a circle, and then shrink the boundary circles. Shrinking a circle is equivalent to identifying it to a point, which is achieved by attaching a 2-disk, we will call this *capping the circle* operation.

We begin by thickening the 3-manifold, i.e., crossing with an interval. In particular, this amounts to thickening the pair of attaching 2-disks of the three dimensional 1-handle to 3-balls (the attaching balls of the four dimensional 1-handle). The attaching circles of the 2-handles inherit the blackboard framing from the 2-dimensional Heegard diagram. The blackboard framing can be computed as the *writhe* of the attaching knot of the 2-handle, i.e., the signed number of self crossings, which turns out to be 0 in our case. After thickening, we need to take the double. Thickening and taking the double is the same as crossing with a circle and capping the boundary circles, as the lower dimensional Picture 18 illustrates. Recall that the *double* of a compact n -manifold X is defined to be

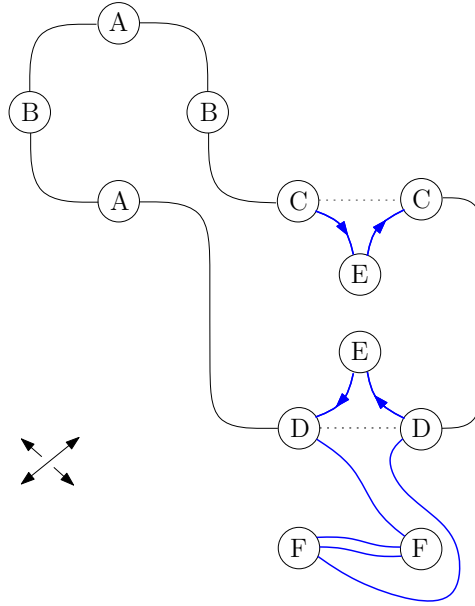

FIGURE 17. Maskit’s 1/3 complex twist operation.



FIGURE 18. $D(Y \times I) = Cap_{\partial Y}(Y \times S^1)$ for the interval Y .

$$DX = \partial(I \times X) = X \cup_{id_{\partial X}} \bar{X}.$$

where \bar{X} is a copy of X with the opposite orientation. We denote the thickened 4-manifold by X , which is a 4-dimensional handlebody without 3- or 4-handles. Then DX automatically inherits a handle decomposition: By turning the handle decomposition of X upside down, we get the dual handle decomposition of \bar{X} , which we attach on top of X getting $DX = X \cup$ dual handles. Note that the duals of 0-, 1- and 2-handles are 4-, 3- and 2-handles, respectively. Since 3-handles are attached in a unique way, they don’t need to be indicated in the picture.

Hence to draw a handlebody picture of the double DX from a given handlebody picture of X , it suffices to understand the position of the new (dual) 2-handles. They are attached by the $id_{\partial X}$ map, along the cocores of the original 2-handles on the boundary. So to get the double we insert a 0-framed meridian to each framed knot, as in the example in Figure 19. The 3- and 4-handles are attached afterwards uniquely to obtain the closed 4-manifold (they don’t need to be drawn in the figure). We will denote

this closed manifold by M_1 , it corresponds the cross identification. We will denote the manifold obtained from the parallel identification by M_2 . Let us denote the corresponding manifolds (with boundary) before the doubling process, by M'_1 and M'_2 respectively, they only have 0-, 1- and 2-handles.

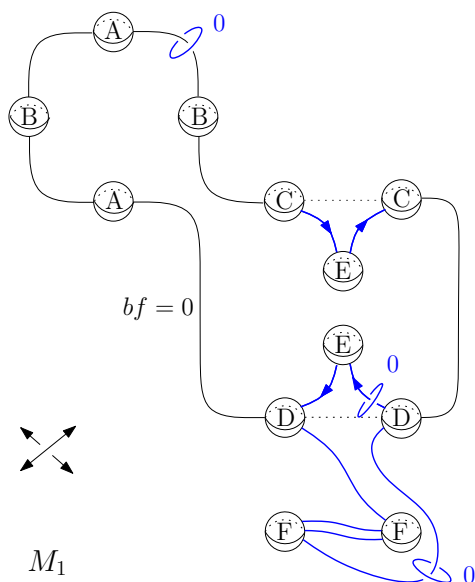

FIGURE 19. Thickening the Heegard Diagram and taking the double.

Now we treat the twisted I -bundle case associated to the surface $\Sigma_{1,2}$. Take a freely acting orientation reversing involution $h : \Sigma_{1,2} \rightarrow \Sigma_{1,2}$, and extend it to an orientation preserving homeomorphism

$$h' : \Sigma_{1,2} \times I \rightarrow \Sigma_{1,2} \times I \text{ by } h'(x, t) = (h(x), 1 - t).$$

The resulting quotient $\Sigma_{1,2} \times I / h'$ is a twisted I -bundle over a punctured Klein bottle Kl_1 , which we denote by $Kl_1 \tilde{\times} I$. This could be thought as the quotient $\Sigma_{1,2} \times I / \sim$ as well, where $(x, 1) \sim (h(x), 1)$. Next we thicken and then double it. The thickening will result in $Kl_1 \tilde{\times} I \times I \approx Kl_1 \tilde{\times} D^2$, a twisted disk bundle over the punctured Klein bottle. Figure 20 is the

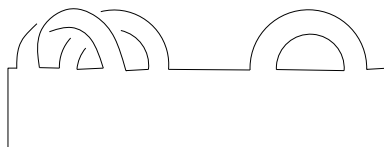

FIGURE 20. One-handles of the punctured Klein bottle Kl_1 .

handlebody of the punctured Klein bottle. Assuming that the framing is

the number f_0 , the twisted disk bundle over the punctured Klein bottle is sketched as in Figure 21. Attaching the round handle E and taking the

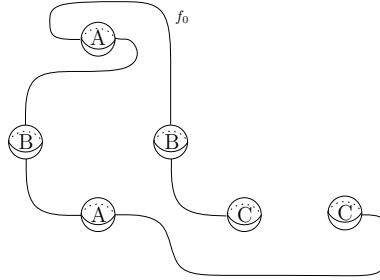

FIGURE 21. *Twisted disk bundle over the punctured Klein bottle.*

double yields the Figure 22. Here, realize that there is a unique way to attach the round handle according to Maskit's procedure. The 3-manifold is also drawn besides the 4-manifold picture. Also, as before, we may twist by $1/3$ to obtain the Figure 23. We denote the resulting manifold by M_3 , and the manifold with boundary before doubling by M'_3 .

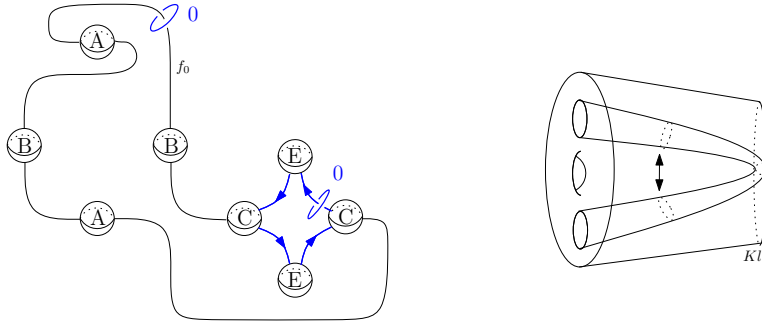

FIGURE 22. *Round handle and the double with the corresponding 3-manifold.*

As a third example, we consider the twisted I -bundle over the twice punctured Klein bottle. We glue the boundary cylinders of the twisted disk bundle over Kl_2 in the cross and parallel fashion to obtain the Figure 24. After these operations, one may want to add the complex twists as well. To simplify the figures, one can use the dotted circle notation of $[A]$ to present our 4-manifolds. For example, Figure 25 is the alternative handlebody picture of the cross manifold just constructed.

Here, we give a procedure of identifying the boundary cylinders of different manifolds. Note that whenever we draw two handlebody diagrams of 4-manifolds next to each other, it means that their handles are attached on a common S^3 i.e., they have the same 0-handle D^4 . So that they can be

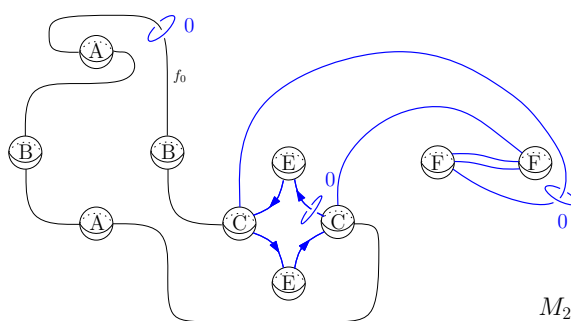

FIGURE 23. Maskit's 1/3 complex twist operation.

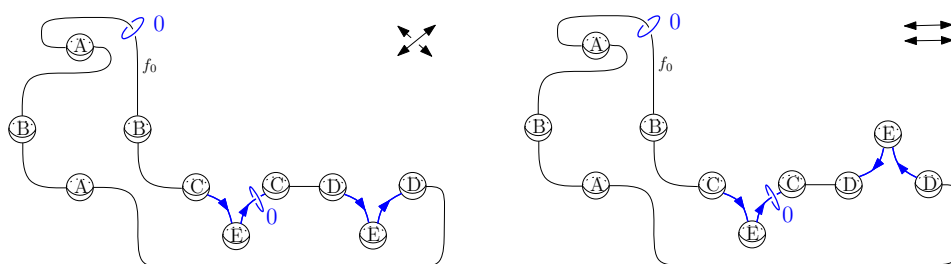

FIGURE 24. Cross and parallel identifications of the boundary cylinders of $Kl_2 \tilde{\times} D^2$.

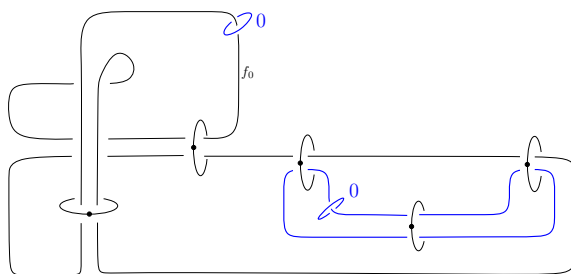

FIGURE 25. Dotted circle convention for the cross manifold of Figure 24.

thought as two separate handlebodies connected by a 1-handle. Hence we only need to use the 2-handle of the round handle to identify the two cylinders. This is how the identification performed for the first pair of cylinders. For the rest of the identifications the regular procedure applies, that is to build a tube (round handle) we need a 1-handle over which the 2-handle passes.

Finally, we draw the handlebody of the 4-manifold corresponding to an example of Maskit, which he constructed from two different (trivial and twisted) types of I -bundles associated to a torus with two holes namely

P_1 and P_2 . He pairs the two ends of P_2 with a pair of cross ends of P_1 , the remaining cross ends of P_1 are identified with one another. This 4-manifold is given by Figure 26. Here, E is the 1-handle of the round handle

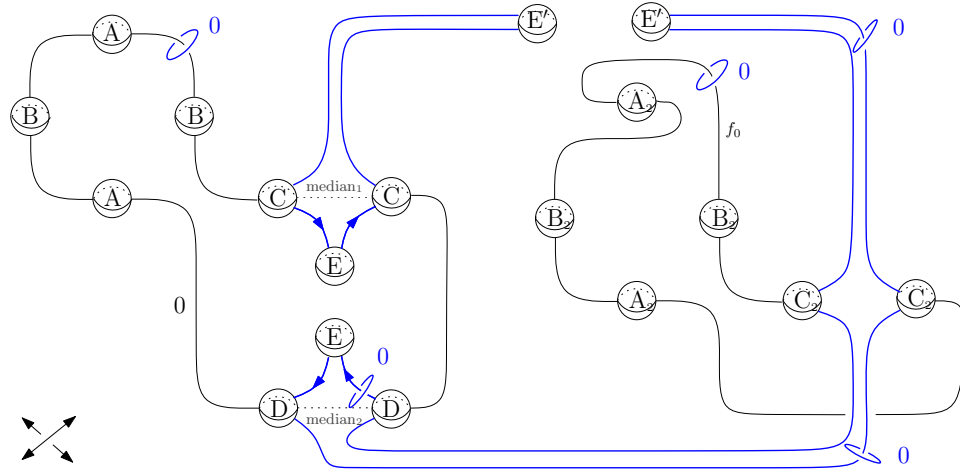

FIGURE 26. 4-manifold corresponding to the Maskit's example.

attaching a pair of cross ends of the 4-manifold corresponding to P_1 . Also C_2 is identified to D by using only a 2-handle, and E' is the 1-handle of the second round handle identifying C_2 to C .

4. Invariants

In this section we compute the topological invariants of the manifolds constructed in the previous section. We first write down the generators and relations of the fundamental groups. We begin with the first set of construction (Figure 19). Each 1-handle is a generator of the fundamental group, and each 2-handle provides a relation. We call the generators a, b, c, d, e, f . We take the convention of left to right and top to bottom to be the positive directions. Then, if we begin from the portion of the first 2-handle joining D to A , going in the direction of A , the first 2-handle provides the relation

$$(1) \quad a^{-1}b^{-1}abcd^{-1} = 1.$$

If we begin with the 1-handle E of the round handle, its 2-handle gives the relation

$$(2) \quad ede^{-1}c^{-1} = 1.$$

Finally, the complex twist handle beginning with F in the reverse direction will provide

$$(3) \quad f^{-3}d^{-1} = 1.$$

If we abelianize this group, the first two relations yield the relation $c = d$ and the third yields $c = f^{-3}$. Since $\langle c, f \mid cf^3 = 1 \rangle = \langle f^{-3}, f \rangle = \langle f \rangle$ the abelianization reduces the number of generators by 2, hence

$$H_1(M_1, \mathbb{Z}) = \mathbb{Z}^4.$$

Computing the second homology group needs more care. Since in the doubling process we attach the upside down handles. Corresponding to each 1-handle, we have a 3-handle. So that the handles generate the chain complex

$$\begin{aligned} 0 &\longrightarrow C_4 \longrightarrow C_3 \longrightarrow C_2 \longrightarrow C_1 \longrightarrow C_0 \longrightarrow 0 \\ 0 &\longrightarrow \mathbb{Z} \longrightarrow \mathbb{Z}^6 \longrightarrow \mathbb{Z}^6 \longrightarrow \mathbb{Z}^6 \longrightarrow \mathbb{Z} \longrightarrow 0. \end{aligned}$$

This gives us the Euler characteristic $\chi(M_1) = 1 - 6 + 6 - 6 + 1 = -4$. So in terms of Betti numbers $-4 = 2b_0 - 2b_1 + b_2$, implying $b_2(M_1) = 2$. This is the free part. Next we compute the torsion piece. By Poincaré duality $H_2(M_1, \mathbb{Z}) \approx H^2(M_1, \mathbb{Z})$, and since $H_1(M_1, \mathbb{Z})$ free the first term of the Universal Coefficient Theorem (e.g., [H]) is zero, we compute

$$\begin{aligned} 0 \rightarrow \text{Ext}(H_1(M_1, \mathbb{Z}), \mathbb{Z}) \rightarrow H^2(M_1, \mathbb{Z}) \rightarrow \text{Hom}(H_2(M_1, \mathbb{Z}), \mathbb{Z}) \rightarrow 0 \\ H_2(M_1, \mathbb{Z}) = \mathbb{Z}^2. \end{aligned}$$

Similarly, we get $H_3 \approx H^1 \approx H_1$ (by Poincaré duality, and $H_0(M_1, \mathbb{Z})$ is free)

$$H_3(M_1, \mathbb{Z}) = \mathbb{Z}^4.$$

The alternative attachment of the round handle as E in Figure 15(a) gives the alternative for the second relation (2)

$$(4) \quad ed^{-1}e^{-1}c^{-1} = 1$$

which yields $c = d^{-1}$ in the abelianization process, combining with the $c = d$ of (1) yields $c^2 = 1$. This implies that the relation $d = f^{-3}$ of (2) enforces $f^6 = 1$. So that the first homology group becomes

$$H_1(M_2, \mathbb{Z}) = \langle a, b, e, f \mid f^6 = 1 \rangle \approx \mathbb{Z}^3 \oplus \mathbb{Z}_6.$$

The Euler characteristic $\chi(M_2) = -4$ since number of handles do not change, which implies $b_2(M_2) = 0$. Also $\text{Ext}(\mathbb{Z}^3 \oplus \mathbb{Z}_6, \mathbb{Z}) = \mathbb{Z}_6$ becomes the torsion part of

$$H_2(M_2, \mathbb{Z}) = \mathbb{Z}_6.$$

Again by $H_3 \approx H^1 \approx \text{Hom}(H_1, \mathbb{Z})$ we have

$$H_3(M_2, \mathbb{Z}) = \mathbb{Z}^3.$$

Similarly, in the second set of constructions, in Figure 23 we have the relations

$$a^{-1}babc = 1, \quad ec^{-1}e^{-1}c = 1, \quad f^{-3}c = 1.$$

The first and third relation imposes restrictions so that

$$H_1(M_3, \mathbb{Z}) = \langle a, b, c, e, f \mid c = b^{-2} = f^3 \rangle = \langle a, e, bf \rangle \approx \mathbb{Z}^3$$

since $(bf)^3 = b$, $(bf)^{-2} = f$ and $(bf)^{-6} = c$. The Euler characteristic is $\chi(M_3) = 1 - 5 + 6 - 5 + 1 = -2$. So $b_2(M_3) = 2$. H_1 and H_0 has no torsion, hence

$$H_2(M_3, \mathbb{Z}) = \mathbb{Z}^2 \text{ and } H_3(M_3, \mathbb{Z}) = \mathbb{Z}^3.$$

The signatures are $\sigma(M_{1,2,3}) = 0$ so that $b_2^\pm(M_{1,3}) = 1$, $b_2^\pm(M_2) = 0$ and the the intersection forms are [Br]

$$Q_{M_{1,3}} = \begin{bmatrix} 0 & 1 \\ 1 & 0 \end{bmatrix} := H \text{ and } Q_{M_2} = (0).$$

The invariants of the other two type of variations can be similarly calculated.

5. Sequences of metrics

Our goal in this section will be to combine our building blocks to construct some interesting sequences of 4-manifolds admitting LCF metrics. We begin by exploiting the first example described by Figure 19. There is no harm to replace the torus, with any genus- g surface. We call the 4-manifolds arisen this way as M_g^1 . In this case the relation

$$a_1^{-1}b_1^{-1}a_1b_1 \cdots a_g^{-1}b_g^{-1}a_gb_gcd^{-1} = 1$$

replaces the relation (1); other relations (2), (3) remain. If we let $g \rightarrow \infty$, then we obtain

$$b_1(M_g^1) = 2g + 2 \rightarrow \infty,$$

$$b_2(M_g^1) = 2,$$

$$\chi(M_g^1) = -4g \rightarrow -\infty.$$

Clearly $\sigma(M_g^1) = 0$ and $Q_{M_g^1} = H$, both stay constant as we take the limit.

Secondly, we may increase the number of CDE components in (19) and omit the complex twist handle F for simplicity. We denote the resulting manifold $M_{g,n}^2$ (or sometimes $M_{g,n}^1$) where n stands for the number of CDE components. See Figure 27. The orientations for A handles are taken to be counterclockwise, and for B handles to be clockwise. The relations for 1-handles are

$$a_1^{-1}b_1^{-1}a_1b_1 \cdots a_g^{-1}b_g^{-1}a_gb_gc_1 \cdots c_nd_n^{-1} \cdots d_1^{-1} = 1$$

$$e_id_ie_i^{-1}c_i^{-1} = 1 \text{ for } i = 1 \cdots n.$$

So that we obtain

$$b_1(M_{g,n}^2) = 2g + 2n \rightarrow \infty,$$

$$b_2(M_{g,n}^2) = 2$$

and

$$\chi(M_{g,n}^2) = 4 - 4g - 4n \rightarrow -\infty$$

as $n \rightarrow \infty$, and the intersection forms are given by $Q_{M_{g,n}^2} = H$.

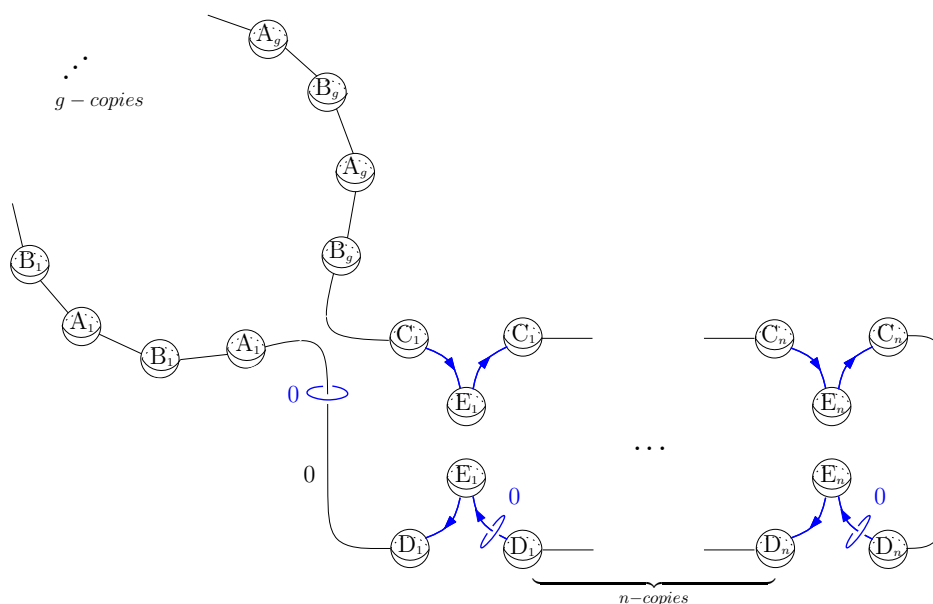

FIGURE 27. The LCF manifolds $M_{g,n}^2$.

In the third sequence, we will make use of another building block. This will be the trivial I -bundle over a punctured annulus $\Sigma_{0,3}$. The corresponding 4-manifold can be obtained by doubling the trivial disk bundle over $\Sigma_{0,3}$. Disk bundles over S^2 are sketched as n -framed unknot. We only need to dig holes by attaching three 1-handles. As a result the handlebody diagram is going to look as in Figure 28. We could have cancelled the 2-handles along

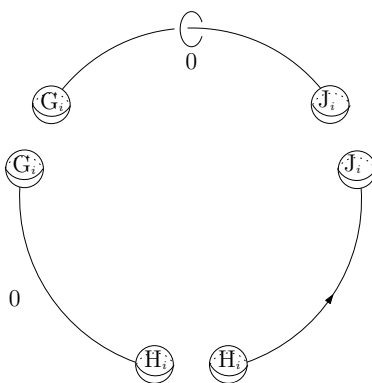

FIGURE 28. Doubling the $D^2 \times \Sigma_{0,3}$.

with a 1-handle and this makes it diffeomorphic to $S^1 \times S^3 \# S^1 \times S^3$. However we cannot make any handle cancellation at this point as it will destroy

one of holes which we are using for attachment. Next we will attach this piece through the D_i handles. Since we are attaching a different manifold, the round handle of the first identification has no 1-handle, the rest of the round handles are as usual. We attach it n -times and denote the resulting manifold by $M_{g,n}^3$. See Figure 29. The original 1-handle gives us a similar relation

$$a_1^{-1}b_1^{-1}a_1b_1 \cdots a_g^{-1}b_g^{-1}a_gb_gd_n^{-1} \cdots d_1^{-1} = 1 \Rightarrow d_1 \cdots d_n = 1.$$

on the other hand each attached new piece provides the relations

$$\begin{aligned} g_i^{-1}d_i^{-1} &= 1 \Rightarrow d_i = g_i^{-1}, \\ k_i h_i k_i^{-1} g_i &= 1 \Rightarrow h_i = g_i^{-1}, \\ l_i^{-1} j_i l_i h_i &= 1 \Rightarrow h_i = j_i^{-1}, \\ m_i^{-1} d_i^{-1} m_i j_i^{-1} &= 1 \Rightarrow d_i = j_i^{-1}, \\ g_i h_i j_i &= 1 \Rightarrow j_i = 1, \end{aligned}$$

where the right hand side of the arrows indicate the outcome in the abelianization process, so that we obtain $1 = j_i = h_i = g_i = d_i$ and the three free variables k_i, l_i, m_i emerge from each attachment. Counting these along with a_i, b_i for $i = 1 \cdots g$ we have

$$b_1(M_{g,n}^3) = 2g + 3n.$$

The Euler characteristic is computed at the chain level as

$$\chi(M_{g,n}^3) = 2 - 2(2g + 7n) + (10n + 2) = 4 - 4g - 4n.$$

From here we get

$$b_2(M_{g,n}^3) = 2 + 2n.$$

So that $b_1, b_2 \rightarrow \infty$ and $\chi \rightarrow -\infty$ as $n \rightarrow \infty$. The main difference of this sequence of metrics from the previous ones is that b_2 gets arbitrarily large rather than staying constant. If we let $g \rightarrow \infty$ instead, then $b_1 \rightarrow \infty$, $\chi \rightarrow -\infty$ and $b_2 = \text{constant}$, a behaviour similar to the previous situations.

Our final sequence of panelled web manifolds is obtained by attaching many copies of the new building block to each other as a chain. One uses round handles without 1-handles to attach each copy, and finally when closing up the line to a chain we use a complete round handle. So that our chain contains only one complete round handle. Figure 30 shows the case for $n = 3$. Again we have the relations

$$\begin{aligned} k_i h_i k_i^{-1} g_i &= 1 \Rightarrow h_i = g_i^{-1}, \\ l_i^{-1} j_i l_i h_i &= 1 \Rightarrow h_i = j_i^{-1}, \\ g_i h_i j_i &= 1 \Rightarrow j_i = 1. \end{aligned}$$

The generators g_i, h_i, j_i for the first homology are homologous to each other and moreover are trivial. Only k_i, l_i for $i = 1 \cdots n$ and m survive, so

$$b_1(M_n^4) = 2n + 1.$$

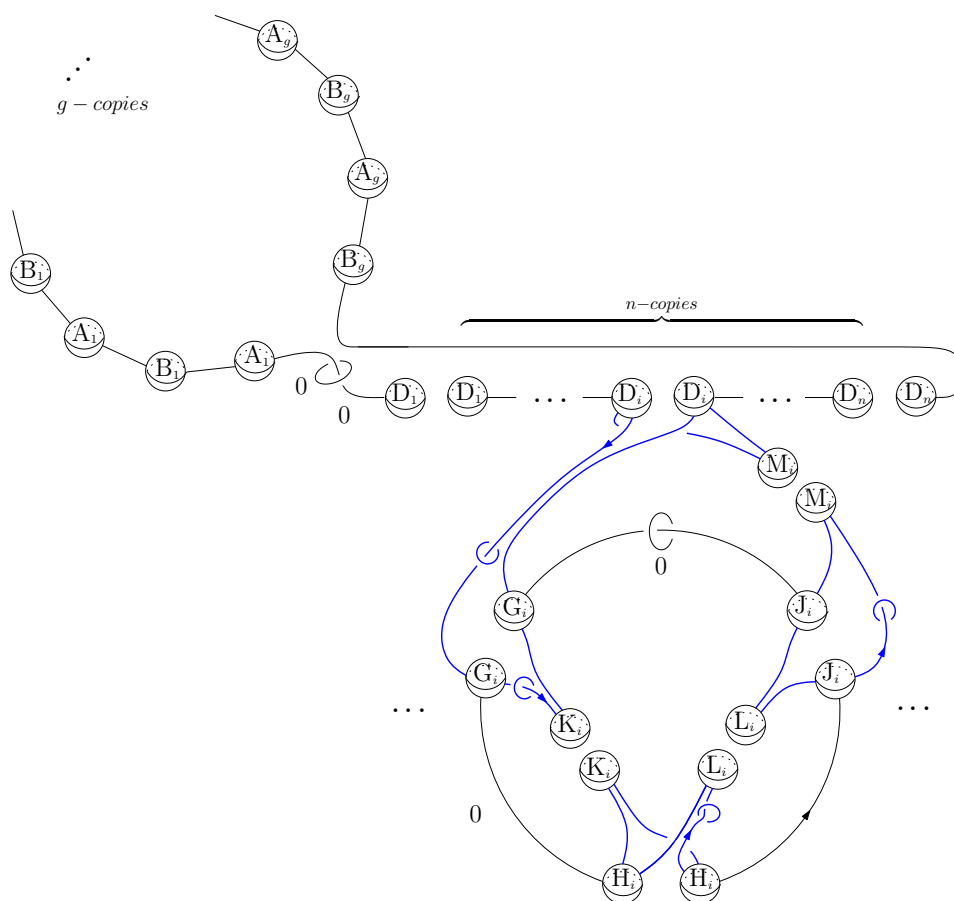

FIGURE 29. The LCF manifolds $M_{g,n}^3$.

The Euler characteristic

$$\chi(M_n^4) = 2 - 2(5n + 1) + 8n = -2n,$$

and from these

$$b_2(M_n^4) = 2n.$$

Again we have $b_1, b_2 \rightarrow \infty$ and $\chi \rightarrow -\infty$ as $n \rightarrow \infty$.

6. Sign of the scalar curvature

In this section, we will verify the Theorem 1.3 on the sign of the scalar curvature. We will be using the results of LeBrun in [LeSD] in this section unless otherwise stated. Main tool is the Weitzenböck formula of [Bou] involving the Weyl curvature. On a Riemannian manifold, the Hodge/modern

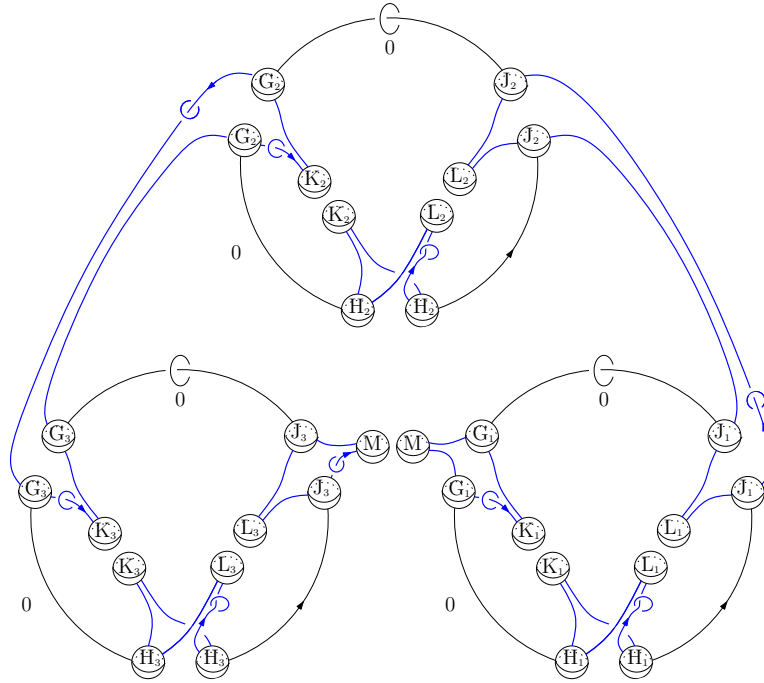

FIGURE 30. *The LCF manifold M_3^4 .*

Laplacian can be expressed in terms of the connection/rough Laplacian as

$$(d + d^*)^2 = \nabla^* \nabla - 2W + \frac{s}{3}$$

where ∇ is the Riemannian connection and W is the Weyl curvature tensor. First observation is that if there is a LCF metric of positive scalar curvature on a manifold, then the second Betti number $b_2 = 0$. Recall that any de Rham cohomology class can be represented by a harmonic form uniquely on a closed manifold. One starts with an arbitrary harmonic 2-form and feeds it to the above formula. Then taking the inner product with the form and integrating over the manifold forces the norm of the form to vanish. The zero scalar curvature case is more delicate. We will be using the following result, alternative exposition of which can be accessed through [LeOM] as well.

Theorem 6.1 ([LeSD]). *Let (M, g) be a closed, scalar-flat anti-self-dual (SF-ASD) 4-manifold, then either:*

- $b_2^+ = 0$, or
- $b_2^+ = 1$ and g is a scalar-flat Kähler metric, or
- $b_2^+ = 3$ and g is a hyper-Kähler metric.

The origin of the numbers 1 and 3 here is the possible number of the generating complex structures. Parallel self-dual 2-forms have constant length

hence they correspond to compatible almost complex structures on a manifold and they are determined by their value at a point. Moreover each independent parallel form reduces the holonomy. If $b_2 \neq 0$ for a SF-LCF manifold then since $\tau = 0$ we are in the Kähler case. We are able to use the following result.

Theorem 6.2 ([LeSD]). *Let (M, g) be a closed, self-dual, Kähler, spin 4-manifold of type zero, then M is isometrically diffeomorphic to one of the following:*

- a K3 surface with a Yau metric,
- a flat 4-torus modulo a finite group, or
- a flat 2-sphere bundle over a Riemann surface of genus ≥ 2 with local product metric.

The idea here is to use spin Weitzenböck formula for nonzero signature to get a trivial canonical bundle, and in the zero signature case, the metric is LCF, and reducing the holonomy to a subgroup of $U(1) \times U(1)$ to get a Riemannian splitting. Applying to our case, the first two cases are eliminated by the signature. panelled web 4-manifolds are not of the last two cases either. So that, they are not of zero type either, in the $b_2 \neq 0$ case.

If one thinks in terms of metrics, one can verify this sign using the results of [SY, Na] even in the $b_2 = 0$ case. Computation of the sign of the scalar curvature for our LCF manifolds is related to the Hausdorff dimension of the Kleinian groups used to uniformize the hyperbolic 3-manifold. A basic observation of [Br] is that the Kleinian group G of an hyperbolic 3-manifold acts on S^4 by the following orientation preserving conformal diffeomorphism:

$$i : \mathbb{H}^3 \times S^1 \rightarrow \mathbb{R}^2 \times (\mathbb{R}^2)^* \approx \mathbb{R}^4 - \mathbb{R}^2 \approx S^4 - S^2$$

$$(x, y, t, \theta) \mapsto (x, y, t \cos \theta, t \sin \theta)$$

where $x, y \in \mathbb{R}, t \in \mathbb{R}^+$ are the coordinates of the hyperbolic space. The circle action in the domain corresponds to the rotations of $\mathbb{R}^2 \times \mathbb{R}^{2*}$ in the second component. When we continuously extend this map to the boundary, we obtain the compactification map $i : \mathbb{H}^3 \times S^1 \rightarrow S^4$. $\text{PSL}(2, \mathbb{C})$ acts on \mathbb{H}^3 to result \bar{M}^3 as well as on S^4 on the right by conformal transformations, i.e., fractional linear transformations

$$\mathbb{HP}_1 \times \text{PSL}(2, \mathbb{C}) \rightarrow \mathbb{HP}_1$$

$$\left([x, y], \begin{bmatrix} a & c \\ b & d \end{bmatrix} \right) \mapsto [xa + yb, xc + yd].$$

The circle action is free in the interior, its fixed point set is the boundary $S^2 \times S^1$, which maps to the S^2 of the image S^4 . $S^1 \times \text{PSL}(2, \mathbb{C})$ acts equivariantly with respect to i . If Λ is the limit set of G , the limit set of the G -action on S^4 equals $i(\Lambda \times S^1)$, since the circle action does not move the boundary S^2 this limit set is isomorphic to Λ . Summarizing $\Lambda \subset \mathbb{CP}_1 \subset \mathbb{HP}_1$. Considering the inclusions $G \subset \text{PSL}(2, \mathbb{C}) \subset \text{PGL}(2, \mathbb{H})$, we can state the result of

Schoen–Yau and the refinement of Nayatani which helps us to compute the sign.

Theorem 6.3 ([SY, Na]). *Let $(X, [g])$ be a compact, LCF 4-manifold, which is uniformized by taking the quotient of $\Omega \subset S^4$ by the Kleinian group $G \subset \text{PGL}(2, \mathbb{H})$ of conformal transformations of $\mathbb{H}\mathbb{P}_1$. Let $g \in [g]$ be a metric (in the conformal class) of constant scalar curvature which exists by the solution of the Yamabe Problem. Assume that the limit set Λ of G is infinite, and the Hausdorff dimension $\dim(\Lambda) > 0$. Then the sign of the scalar curvature is equal to the sign of $1 - \dim(\Lambda)$.*

We will see that the LCF manifolds constructed in the previous sections are all of (strictly) negative scalar curvature type. To be able to make use of Theorem 6.3 we begin with a definition and cite some results in hyperbolic geometry.

Definition 6.4 ([CaMiTa]). A compact irreducible 3-manifold M with incompressible boundary is called a *generalized book of I-bundles* if one may find a disjoint collection A of essential annuli in M such that each component R of the manifold obtained by cutting M along A is either a solid torus, a thickened torus, or homeomorphic to an I-bundle such that $\partial R \cap \partial M$ is the associated ∂I -bundle.

For a hyperbolic 3-manifold (M, g) , let $d(M, g)$ or $d(M)$ denote the Hausdorff dimension of the limit set of the discrete group which acts on the hyperbolic space isometrically to give (M, g) as the quotient. By minimizing d over all of the supporting hyperbolic structures, we obtain a topological invariant of M :

$$D(M) := \inf \{d(M, g) \mid g \text{ is a complete hyperbolic metric on } M\}.$$

Theorem 6.5 ([BisJon]). *Let M be a compact, orientable, hyperbolic 3-manifold. If $d(M) = 1$ then M is either a handlebody or an I-bundle. (If $d(M) < 1$ then M is a handlebody or a thickened torus.)*

Theorem 6.6 ([CaMiTa] Main Theorem II, Corollary 2.4). *Let M be a compact, orientable, hyperbolizable 3-manifold which is not a handlebody or a thickened torus. Then $D(M) \geq 1$.*

If we combine these two theorems, we see that $d(M, g) > 1$ for our hyperbolic metrics. So that $1 - d < 0$, hence the scalar curvature is strictly negative for our LCF 4-manifolds according to the Theorem 6.3. We should keep in mind the equality $d(M, g) = \dim(\Lambda)$, as explained prior to the theorem.

The theorem of Schoen–Yau and the refinement of Nayatani is actually more general than what we have stated in Theorem 6.3, and it is valid for all dimensions $n \geq 3$. The group of conformal transformations of the n -sphere is the group of isometries of the hyperbolic $(n+1)$ -ball by the Liouville’s theorem [dC]. The isometry group of the hyperbolic ball on the other hand

is computed by considering it as the imaginary upper unit sphere in the Minkowski space $\mathbb{R}^{n+1,1}$. The transformations that preserve the indefinite metric and the orientation happen to preserve the upper sheet of the hyperboloid [dC, Pet] so that

$$\text{Conf}(S^n) = \text{Isom}(B_h^{n+1}) = SO^\uparrow(n+1, 1).$$

Consequently, the uniformizing Kleinian group is a subgroup of this Lie group. In the particular cases we have [LeOM]

$$\text{Conf}(\mathbb{H}\mathbb{P}_1) = \text{PGL}(2, \mathbb{H}) = SO^\uparrow(5, 1)$$

$$\text{Conf}(\mathbb{C}\mathbb{P}_1) = \text{PSL}(2, \mathbb{C}) = SO^\uparrow(3, 1).$$

In the general case, the sign of the scalar curvature is equal to the sign of the quantity

$$\frac{n}{2} - 1 - \dim(\Lambda).$$

References

- [A] AKBULUT, SELMAN. On 2-dimensional homology classes of 4-manifolds. *Math. Proc. Cambridge Philos. Soc.* **82** (1977), no. 1, 99–106. MR0433476 (55 #6452), Zbl 0355.57013, doi: 10.1017/S0305004100053718.
- [AKO] ARGÜZ, HÜLYA; KALAFAT, MUSTAFA, OZAN, YILDIRAY. Self-Dual metrics on non-simply connected 4-manifolds. *Journal of Geometry and Physics*, In press, 2012. arXiv:1108.0433, doi: 10.1016/j.geomphys.2012.08.005.
- [AK] ARGÜZ, HÜLYA; KALAFAT, MUSTAFA. Complex and symplectic structures on panelled web 4-manifolds. *Topology Appl.* **159**, (2012), no. 8, 2168–2173. MR2902751, Zbl 1243.57020, arXiv:1201.4605, doi: 10.1016/j.topol.2012.02.009.
- [AHS] ATIYAH, M. F.; HITCHIN, N. J.; SINGER, I. M. Self-duality in four-dimensional Riemannian geometry. *Proc. Roy. Soc. London Ser. A* **362** (1978), no. 1711, 425–461. MR0506229 (80d:53023), Zbl 0389.53011, doi: 10.1098/rspa.1978.0143.
- [Bes] BESSE, ARTHUR L. Einstein manifolds, Reprint of the 1987 edition. *Classics in Mathematics. Springer-Verlag, Berlin*, 2008. xii+516 pp. ISBN: 978-3-540-74120-6. MR2371700 (2008k:53084), Zbl 1147.53001.
- [BisJon] BISHOP, CHRISTOPHER J.; JONES, PETER W. Hausdorff dimension and Kleinian groups. *Acta Math.* **179** (1997), no. 1, 1–39. MR1484767 (98k:22043), Zbl 0921.30032, arXiv:math/9403222, doi: 10.1007/BF02392718.
- [Bou] BOURGUIGNON, JEAN-PIERRE. Les variétés de dimension 4 à signature non nulle dont la courbure est harmonique sont d'Einstein. *Invent. Math.* **63** (1981), no. 2, 263–286. MR0610539 (82g:53051), Zbl 0456.53033, doi: 10.1007/BF01393878.
- [Br] P.J. BRAAM. A Kaluza-Klein approach to hyperbolic three-manifolds. *Enseign. Math.* (2) **34** (1988), no. 3–4, 275–311. MR0979644 (89m:57013), Zbl 0684.53028.
- [CaMiTa] CANARY, RICHARD D.; MINSKY, YAIR N.; TAYLOR, EDWARD C. Spectral theory. Hausdorff dimension and the topology of hyperbolic 3-manifolds. *J. Geom. Anal.* **9** (1999), no. 1, 17–40. MR1760718 (2001f:57016), Zbl 0957.57012, arXiv:math/9810124.
- [dC] DO CARMO, MANFREDO PERDIGÃO. Riemannian geometry. Translated from the second Portuguese edition by Francis Flaherty. *Mathematics Theory & Applications. Birkhäuser Boston, Inc., Boston, MA*, 1992. xiv+300 pp. ISBN: 0-8176-3490-8. MR1138207 (92i:53001), Zbl 0752.53001.

- [GS] GOMPF, ROBERT E.; STIPSICZ, ANDRÁS I. 4-Manifolds and Kirby Calculus. Graduate Studies in Mathematics, 20. *American Mathematical Society, Providence, RI*, 1999. xvi+558 pp. ISBN: 0-8218-0994-6. MR1707327 (2000h:57038), Zbl 0933.57020.
- [H] HATCHER, ALLEN. Algebraic topology. *Cambridge University Press, Cambridge*, 2002. xii+544 pp. ISBN: 0-521-79160-X. MR1867354 (2002k:55001), Zbl 1044.55001.
- [K] KALAFAT, MUSTAFA LCF and self-dual structures on simple 4-manifolds. Preprint.
- [Kim] KIM, JONGSU. On the scalar curvature of self-dual manifolds. *Math. Ann.* **297** (1993), no. 2, 235–251. MR1241804 (95e:53068), Zbl 0789.53025, doi: 10.1007/BF01459499.
- [KiLePo] KIM, JONGSU; LEBRUN, CLAUDE; PONTECORVO, MASSIMILIANO. Scalar-flat Kähler surfaces of all genera. *J. Reine Angew. Math.* **486** (1997), 69–95. MR1450751 (98m:32045), Zbl 0876.53044, arXiv:dg-ga/9409002.
- [LeH] LEBRUN, CLAUDE. Anti-self-dual Hermitian metrics on blown-up Hopf surfaces. *Math. Ann.* **289** (1991), no. 3, 383–392. MR1096177 (92c:53029), Zbl 0728.53039, doi: 10.1007/BF01446578.
- [LeEx] LEBRUN, CLAUDE. Explicit self-dual metrics on $CP_2 \# \dots \# CP_2$. *J. Differential Geom.* **34** (1991), no. 1, 223–253. MR1114461 (92g:53040), Zbl 0725.53067.
- [LeOM] LEBRUN, CLAUDE. Curvature functionals, optimal metrics, and the differential topology of 4-manifolds. *Different Faces of Geometry*, 199–256. Int. Math. Ser. (N.Y.), 3, *Kluwer/Plenum, New York*, 2004. MR2102997 (2005h:53055), Zbl 1088.53024, arXiv:math/0404251, doi: 10.1007/0-306-48658-X_5.
- [LeSD] LEBRUN, CLAUDE. On the topology of self-dual 4-manifolds. *Proc. Am. Math. Soc.* **98** (1986), no. 4, 637–640. MR0861766 (87k:53107), Zbl 0606.53029, doi: 10.1090/S0002-9939-1986-0861766-2.
- [LeR] LEBRUN, CLAUDE. Scalar-flat Kähler metrics on blown-up ruled surfaces. *J. Reine Angew. Math.* **420** (1991), 161–177. MR1124569 (92i:53066), Zbl 0727.53067, doi: 10.1515/crll.1991.420.161.
- [MaC1] MASKIT, BERNARD. On Klein’s combination theorem. *Trans. Amer. Math. Soc.* **120** (1965), 499–509. MR192047 (33 #274), Zbl 0138.06803, doi: 10.1090/S0002-9947-1965-0192047-1.
- [MaC2] MASKIT, BERNARD. On Klein’s combination theorem. II. *Trans. Amer. Math. Soc.* **131** (1968), 32–39. MR0223570 (36 #6618), Zbl 0162.10602, doi: 10.1090/S0002-9947-1968-0223570-1.
- [MaC3] MASKIT, BERNARD. On Klein’s combination theorem. III. 1971 *Advances in the Theory of Riemann Surfaces (Proc. Conf., Stony Brook, N.Y., 1969)* pp. 297–316. Ann. of Math. Studies, No. 66 *Princeton Univ. Press, Princeton, N.J.* MR0289768 (44 #6955), Zbl 0222.30029.
- [MaKG] MASKIT, BERNARD. Kleinian groups. Grundlehren der Mathematischen Wissenschaften [Fundamental Principles of Mathematical Sciences], 287 *Springer-Verlag, Berlin*, 1988. xiv+326 pp. ISBN: 3-540-17746-9. MR0959135 (90a:30132), Zbl 0627.30039.
- [MaPG] MASKIT, BERNARD. Panelled web groups *Kleinian groups and related topics (Oaxtepec, 1981)* pp. 79–108, Lecture Notes in Math., 971. *Springer, Berlin-New York*, 1983. MR0690280 (84f:30056), Zbl 0504.30037.
- [Mat] MATSUMOTO, SHIGENORI. Foundations of flat conformal structure. *Aspects of low-dimensional manifolds*, 167–261, Adv. Stud. Pure Math., 20. *Kinokuniya, Tokyo*, 1992. MR1208312 (93m:57014), Zbl 0816.53020.

- [MaTa] MATSUZAKI, KATSUHIKO; TANIGUCHI, MASAHIKO. Hyperbolic manifolds and Kleinian groups. Oxford Mathematical Monographs. Oxford Science Publications. *The Clarendon Press, Oxford University Press, New York*, 1998. x+253 pp. ISBN: 0-19-850062-9 MR1638795 (99g:30055), Zbl 0892.30035.
- [Na] NAYATANI, SHIN. Patterson-Sullivan measure and conformally flat metrics. *Math. Z.* **225** (1997), no. 1, 115–131. MR1451336 (98g:53072), Zbl 0868.53024, doi: 10.1007/PL00004301.
- [Pen] PENROSE, ROGER. Nonlinear gravitons and curved twistor theory. The riddle of gravitation - on the occasion of the 60th birthday of Peter G. Bergmann (Proc. Conf., Syracuse Univ., Syracuse, N. Y., 1975). *General Relativity and Gravitation* **7** (1976), no. 1, 31–52. MR0439004 (55 #11905), Zbl 0354.53025.
- [Pet] PETERSEN, PETER. Riemannian Geometry. Graduate Texts in Mathematics, 171. *Springer-Verlag, New York, NY*, 1998. xvi+432 pp. ISBN: 0-387-98212-4. MR1480173 (98m:53001), Zbl 0914.53001.
- [SY] SCHOEN, R.; YAU, S.-T.. Conformally flat manifolds, Kleinian groups and scalar curvature. *Invent. Math.* **92** (1988), no. 1, 47–71. MR0931204 (89c:58139), Zbl 0658.53038, doi: 10.1007/BF01393992.
- [TV] TIAN, GANG; VIACLOVSKY, JEFF. Moduli spaces of critical Riemannian metrics in dimension four. *Adv. Math.* **196** (2005), no. 2, 346–372. MR2166311 (2006i:53051), Zbl 02213018, arXiv:math/0312318, doi: 10.1016/j.aim.2004.09.004.
- [JV] VIACLOVSKY, JEFF. Lecture Notes on Differential Geometry. 2007

MATHEMATICS DEPARTMENT, MICHIGAN STATE UNIVERSITY, EAST LANSING, MI 48824
akbulut@math.msu.edu

MATHEMATICS DEPARTMENT, UNIVERSITY OF WISCONSIN AT MADISON
Current address: Tunceli Üniversitesi, Bilgisayar Mühendisliği Bölümü, Turkiye.
kalafg@gmail.com

This paper is available via <http://nyjm.albany.edu/j/2012/18-39.html>.